

24

25

Catálogo

ESCOLAR



ÍNDICE

3M	243	Grafoplás	246	Pelikan	146
Additio	232	Herlitz	145	Pentel	41
Alpino	125	Hohner	81	Petrus	288
Alpino Baby	124	HP	305	Pigna Junior	179
Apli	91	Iberplas	280	Pilot	29
Bic	3	Ibico	294	Plico	206
Bic Kids/Plastidecor	7	Imedio	209	Precision	152
Canson	77	Informática	311	Pritt	200
Carchivo	268	Inoxcrom	199	Pryse	158
Carioca	36	Instant	202	Rapesco	266
Casio	306	Jaer	90	Rebell	303
Cenefas	89	Jovi	108	Rebost del Paper	150
Centrum	99	Kensington	292	Renolit	89
Colorline	256	Kum	69	Rexel	291
Dacs	136	La Pajarita	155	Rotring	67
Dahle	263	Lamela	180	Rubio	189
Daler Rowney	144	Laura Roig	179	Sadipal	82
Das	142	Leitz	284	Safta	218
DataBank	275	Loan	278	Schneider	22
Dfh	68	Loctite	201	Senfort	222
Dohe	224	Lyra	143	Sharp	304
Durable	279	Manley	137	Sharpie	20
Dymo	262	Maped	72	Sobres	295
Edding	9	Mariola	240	Stabilo	23
Elba	277	Maxell	314	Staedtler	44
Elmer's	20	Milan	192	Supertite	216
Enri Agendas	229	Miniland	315	Talens	34
Enri Manipulado	166	Miquelrius	244	Tarifold	276
Esselte	282	Navigator	156	Tesa	212
Exacompta	186	NGS	310	Texas Instruments	294
Faber Castell	55	Nobo	293	Tipp-Ex	8
Fabriano	82	Nova Rico	123	Tombow	106
Faibo	70	Novus	264	Transcend	314
Fellowes	298	Office Box	254	Trusens	294
Finocam	236	Olef	160	Uhu	211
Fixo Kids	120	Oxford Agendas	229	Uni	32
Forofis	102	Oxford Manipulado	168	Unilux	267
Fundas plastificar	145	Pacsa	182	Vantage	265
GBC	290	Panasonic	314	Velleda	6
Giotto	138	Paper Mate	19	Viquel	260
Giotto be-bé	138	Pardo	188	Yosan	296
Global Notes	261	Parker	67		
GP	314	Parramón	179		

¿Cómo funciona La devolución de Las agendas?

ADDITIO.....	10%.
DOHE.....	100%.
ENRI.....	No admite devolución
FINOCAM.....	25%.
GRAFOPLAS.....	25%.
OXFORD.....	20%.
SENFORT.....	No admite devolución

La fecha límite
para devolver
Las agendas es
31 - 07 - 24



Vía Pasteur, N°10
Polígono del Tambre
15890 - Santiago de Compostela

Tlfos: 981 583 456 - 981 561 114

distrisantiago@distrisantiago.es
www.distrisantiago.es

Catálogo vigente hasta el 30 de octubre de 2023

*Las promociones del interior del catálogo son vigentes hasta el 30 de octubre de 2023 o hasta agotar existencias.



Bolígrafo Cristal medium (Punta Normal)

Código	Ref.	Color	U/Vta	U/Emb
10102007	8373609	Azul	50	1000
10102011	8373639	Negro	50	1000
10102010	8373619	Rojo	50	1000
10102009	8373629	Verde	50	1000



Bolígrafo Cristal Celebrate

Código	Ref.	Color	U/Vta	U/Emb
10103135	9213401	Oro	20	1000
10103136	921339	Plata	20	1000
10103019	9213381	Expositor de 40	1	1



Bolígrafo Orange Punta Fina

Código	Ref.	Color	U/Vta	U/Emb
10102005	8099221	Azul	20	1000
10102002	8099231	Negro	20	1000
10102003	8099241	Rojo	20	1000



Bolígrafo Cristal Up 1,2 mm

Código	Ref.	Color	U/Vta	U/Emb
10101169	949879	Azul	20	1000
10101170	949880	Negro	20	1000
10101171	950446	Col. Fun surtidos	20	1000



Bolígrafo Cristal Fine

Código	Ref.	Color	U/Vta	U/Emb
10102882	872730	Azul	50	1000
10102881	872731	Negro	50	1000
10102883	872720	Rojo	50	1000



Bolígrafo Cristal Fun

Código	Ref.	Color	U/Vta	U/Emb
10101814	929055	Lila	20	360
10101815	929056	Rosa	20	360
10101816	929074	Azul claro	20	360
10101817	927885	Verde	20	360
10102080	895793	Caja 20	1	10



Bolígrafo Cristal Ultra Fine

Código	Ref.	Color	U/Vta	U/Emb
10101352	992605	Azul	20	1000
10101353	992603	Negro	20	1000
10101354	992604	Rojo	20	1000



Bolígrafo Cristal Large

Código	Ref.	Color	U/Vta	U/Emb
10102880	880656	Azul	50	1000
10102879	880648	Negro	50	1000
10101383	951625	Rojo	50	1000



Bolígrafo Cristal Soft

Código	Ref.	Color	U/Vta	U/Emb
10101736	951434	Azul	50	1000
10101737	951433	Negro	50	1000
10101738	918520	Rojo	50	1000



Bolígrafo retráctil Atlantis Metal clip 1.0

Código	Ref.	Color	U/Vta	U/Emb
10101763	9021322	Azul	12	216
10101764	9021332	Negro	12	216



Bolígrafo retráctil Soft Feel Grip

Código	Ref.	Color	U/Vta	U/Emb
10101230	837397	Negro	12	18
10101231	837398	Azul	12	18
10101232	837399	Rojo	12	18



Roller retráctil Gelo Quick 0,7 mm

Código	Ref.	Color	U/Vta	U/Emb
11201078	950442	Azul	12	216
11201079	949873	Negro	12	216
11201087	949874	Rojo	12	216
11201123	964771	Verde	12	216
11201124	964772	Púrpura	12	216
11201125	964776	Turquesa	12	216
11201126	964777	Rosa	12	216
11201149	964826	Surtido	1	18



Portaminas Velocity 0,7mm

Código	Ref.	U/Vta	U/Emb
12501061	8291332	12	216



Lápiz de grafito Conte Evolution-HB

Código	Ref.	U/Vta	U/Emb
12801217	8803112	12	144



Portaminas Velocity 0,5mm

Código	Ref.	U/Vta	U/Emb
24302387	8291322	12	216



Portaminas Matic Classic

Código	Ref.	Artículo	U/Vta	U/Emb
24302328	820958	0,5 mm	12	960
24302261	8209591	0,7 mm	12	960





R
Incluye Regalo

Contenido:
15x 997202 metal azul
6x 997201 metal negro
50x cristal azul de Regalo

Bolígrafo cristal Re"New
Expositor de 21

Código	Ref.	U/Vta	U/Emb
10101434	501036	1	1



Bolígrafo Velocity borrable
Expositor de 48

Código	Ref.	U/Vta	U/Emb
11201101	943461	1	1



R
Incluye Regalo

Contenido:
12x 982868 Flúor
12x 889969 Medium
24x 919380 Shine
100x 8373609 cristal azul de Regalo

Bolígrafo de 4 colores
Expositor de 48

Código	Ref.	U/Vta	U/Emb
10101076	947131	1	1



R
Incluye Regalo

Contenido:
250x 8373609 Cristal azul
100x 8373639 Cristal negro
50x 8373619 Cristal rojo
50x 8373629 Cristal verde
100x 929056 Fun rosa
80x 929055 Fun morado
20x 927885 Fun lima
80x 929074 Fun turquesa
40x 937417 Fun naranja
150x 8373609 cristal azul de Regalo

Bolígrafo Cristal
Expositor Mega Family

Código	Ref.	U/Vta	U/Emb
10102884	961592	1	1



Bolígrafo 4 Colores Shine
Expositor de 20 unidades

Código	Ref.	U/Vta	U/Emb
10101644	902128	1	1



Bolígrafo 4 colores decorado
Expositor de 30

Código	Ref.	U/Vta	U/Emb
10101436	9649042	1	1



Bolígrafo de 4 colores
Terciopelo 4C Velours
Bote de 30

Código	Ref.	U/Vta	U/Emb
10101204	9672781	1	1



Bolígrafo cuatro colores Counter Pen

Código	Ref.	U/Vta	U/Emb
10101049	918515	1	18



Bolígrafo cuatro colores Mini

Código	Ref.	U/Vta	U/Emb
10103109	895958	12	240



Bolígrafo cuatro colores Grip Medium

Código	Ref.	U/Vta	U/Emb
10101137	8871361	12	216



Bolígrafo cuatro colores Original

Código	Ref.	U/Vta	U/Emb
10102339	982866	12	216



Bolígrafo de 3 + 1 HB (negro, azul, rojo y mina 0,7 HB)

Código	Ref.	U/Vta	U/Emb
10101144	982873	12	18



Bolígrafo cuatro colores Fine

Código	Ref.	U/Vta	U/Emb
10101047	889971	12	18



Bolígrafo cuatro colores Shine

Código	Ref.	Artículo	U/Vta	U/Emb
10101083	982868	Plata	12	12
10101206	982878	Oro	12	12
10101404	504894	Oro rosa	12	12
10101205	982877	Rojo	12	12



Bolígrafo de 4 colores Fluo Neón

Código	Ref.	U/Vta	U/Emb
10101048	982868	12	18



Bolígrafo cuatro colores Wood

Código	Ref.	U/Vta	U/Emb
10101846	508964	12	216



Bolígrafo cuatro colores Gradient

Código	Ref.	U/Vta	U/Emb
10101847	511034	12	216



Marcador flúor Brite Liner Grip

Código	Ref.	Color	U/Vta	U/Emb
10202765	811935	Amarillo	12	216
10202814	811931	Azul	12	216
10202815	811933	Naranja	12	216
10202812	811934	Rosa	12	216
10202813	811932	Verde	12	216



**Marcador flúor Brite Liner Grip pastel
Caja surtida de 12**

Código	Ref.	U/Vta	U/Emb
10204356	504819	1	12





Marcador tinta opaca permanente Marking
Caja de 12

• Gold&Silver

Código	Ref.	U/Vta	U/Emb
10202805	950466	12	1

• Colores Vivos

Código	Ref.	U/Vta	U/Emb
10202806	950468	1	1

• Colores Pastel

Código	Ref.	U/Vta	U/Emb
10202807	950469	1	1



Rotulador Marking CD-DVD negro

Código	Ref.	U/Vta	U/Emb
10201558	8290801	12	216



Rotulador Pizarra Velleda 1741 medium cónico

Código	Ref.	Color	U/Vta	U/Emb
10201243	9581701	Azul	12	384
10201244	9581711	Negro	12	384
10201246	9581691	Rojo	12	384
10201288	9581681	Verde	12	384
10201702	998528	Bolsa de 8	1	6



Rotulador permanente Marking 2000 cónico

Código	Ref.	Color	U/Vta	U/Emb
10201583	8209143	Azul	12	384
10201582	8209153	Negro	12	384
10201584	8209133	Rojo	12	384



Rotulador Pizarra Velleda Liquid Ink

Código	Ref.	Color	U/Vta	U/Emb
10205441	902088	Negro	12	384
10205442	902087	Azul	12	384
10205443	902089	Rojo	12	384
10205444	902090	Verde	12	384



Rotulador Pizarra Velleda Marker 1701 Cónico

Código	Ref.	Color	U/Vta	U/Emb
10201701	904938	Azul	12	288
10201698	904937	Negro	12	288
10201791	904939	Rojo	12	288



Rotulador permanente Marking 2300 biselado

Código	Ref.	Color	U/Vta	U/Emb
10201580	8209253	Azul	12	384
10201579	8209263	Negro	12	384
10201581	8209243	Rojo	12	384



Rotulador Velleda Liquid Ink Tank

Código	Ref.	Color	U/Vta	U/Emb
10205445	902096	Negro	12	288
10205446	902095	Azul	12	288
10205447	902097	Rojo	12	288
10205448	902098	Verde	12	288



Rotulador Pizarra Velleda Marker 1751 Biselado

Código	Ref.	Color	U/Vta	U/Emb
10201247	904947	Azul	12	288
10201249	904946	Negro	12	288
10201250	904948	Rojo	12	288
10201265	904949	Verde	12	288



Pizarra blanca milimetrada Velleda

Código	Ref.	Artículo	U/Vta	U/Emb
23801006	812105	30x44cm	1	6
23801567	1199024513	44x55cm	1	6
23801016	1199000701	60x90cm	1	6



Set Velleda kids School (marcador azul + borrador + pizarra 2 superficies 20x31cm)

Código	Ref.	U/Vta	U/Emb
23801617	841362	3	24



Pizarra Velleda 19x26cm

Código	Ref.	U/Vta	U/Emb
23801005	841360	1	24



Rollo Pizarra Velleda

Código	Ref.	Medida	U/Vta	U/Emb
23801019	870494	45x50	1	10
23801011	870493	67x100	1	6
23801432	870492	100x200	1	6



Rotulador Fibra Kid Couleur - Punta Media

Código	Ref.	Caja	U/Vta	U/Emb
10201074	920293	10+2	1	25
10206032	937510	14+4	1	25
10201836	841800	18+6	1	25



Rotulador de fibra Couleur Baby Caja de 12

Código	Ref.	U/Vta	U/Emb
10203670	9020801	12	12



Rotulador Fibra Kid Couleur XL grueso Estuche de 12

Código	Ref.	U/Vta	U/Emb
10201472	828966	1	12



Lápices de colores Evolution Stripes

Código	Ref.	Caja	U/Vta	U/Emb
12801993	9505221	12 Uds	1	12
12801994	950524	18 Uds	1	12
12801995	950525	24 Uds	1	12



Lápices Kids Evolution Triangle Estuche de 12

Código	Ref.	U/Vta	U/Emb
12801437	8297356	1	12



Ceras Plastidecor

Código	Ref.	Estuche	U/Vta	U/Emb
16001040	8757702	12 uds	1	25
16001041	8757711	18 uds	1	48
16001042	9203011	24 uds	1	48
16001315	882337	36 uds	1	36
16001359	841719	352 uds	1	10



Ceras Plastidecor Exótico Estuche de 12

Código	Ref.	U/Vta	U/Emb
16001082	9339611	1	96



Ceras Plastidecor Peques

Código	Ref.	Caja	U/Vta	U/Emb
16001314	8757741	12 Uds	1	12
16001361	8878331	144 Uds	1	10



Rotulador Fibra Intensity

Código	Ref.	Caja	U/Vta	U/Emb
10203414	978004	12 Uds	1	1
10203415	978005	24 Uds	1	1



Rotulador Dual Brush Intensity Classic & Pastel Caja de 12

Código	Ref.	U/Vta	U/Emb
10204362	503847	1	12



Rotulador Dual Brush Intensity Caja de 12

Código	Ref.	U/Vta	U/Emb
10203416	989695	1	1



Lápices de colores Intensity

Código	Ref.	Caja	U/Vta	U/Emb
12802205	9505272	12 Uds	12	1
12802206	9641481	24 Uds	12	1



Rotulador Dual Brush Intensity Pastel Caja de 6

Código	Ref.	U/Vta	U/Emb
10204361	503826	1	6



Rotulador Dual Brush Intensity Highlighter Caja de 6

Código	Ref.	U/Vta	U/Emb
10204363	503828	1	6



Corrector cinta
Mini Pocket Mouse Flash Bubble
Expositor de 40

Código	Ref.	U/Vta	U/Emb
15103285	931860	1	1



Corrector Casete Micro Tape Twist
5 mm x 8 m
Expositor de 60

Código	Ref.	U/Vta	U/Emb
15103249	8794321	1	1



Corrector Casete Mini Pocket Mouse
5mm x 5m

Código	Ref.	U/Vta	U/Emb
15103040	932564	10	120



Corrector Casete Pocket Mouse
4,2mm x 10 m

Código	Ref.	U/Vta	U/Emb
15103050	8207892	10	120



Corrector cinta Easy Correct
4,2 mm x 12 m

Código	Ref.	U/Vta	U/Emb
15101052	8290352	10	120



Corrector Frasco 20 ml

Código	Ref.	U/Vta	U/Emb
15103008	8859923	10	120



Corrector bolígrafo 8ml

Código	Ref.	U/Vta	U/Emb
15103021	8024232	10	120



Corrector Casete Micro Tape Twist
5 mm x 8 m

Código	Ref.	U/Vta	U/Emb
15103228	8706142	10	100



Corrector bolígrafo Mini 4 ml

Código	Ref.	U/Vta	U/Emb
15103197	8481612	10	120



Rotulador 1200 Estuche metálico

Código	Ref.	Cantidad	U/Vta	U/Emb
10205216	1200/10 S	10 Surt.	1	48
10205217	1200/20 S	20 Surt.	1	24

Rotulador de fibra 1200 trazo 1 mm

Código	Ref.	Color	U/Vta	U/Emb
10205002	120001	Negro	10	1000
10205003	120002	Rojo	10	1000
10205001	120003	Azul	10	1000
10205004	120004	Verde	10	1000
10205005	120005	Amarillo	10	1000
10205006	120006	Naranja	10	1000
10205135	120007	Marrón	10	1000
10205045	120008	Violeta	10	1000
10205060	120009	Rosa	10	1000
10205046	120010	Azul Claro	10	1000
10205047	120011	Verde Claro	10	1000
10205061	120012	Gris	10	1000
10205063	120014	Azul Turquesa	5	1000
10205064	120015	Verde Oliva	5	1000
10205065	120016	Naranja Claro	5	1000
10205066	120017	Azul Acero	5	1000
10205067	120018	Marrón Oscuro	5	1000
10205050	120019	Carmin	5	1000
10205048	120020	Magenta	5	1000
10205049	120028	Burdeos	5	1000
10205092	120064	Verde Neón	10	1000
10205093	120065	Amarillo Neón	10	1000
10205094	120066	Naranja Neón	10	1000
10205095	120069	Rosa Neón	10	1000
10202916	1200083	Melón pastel	10	1000
10202917	1200058	Flor de cerezo pastel	10	1000
10202918	1200087	Lavanda con frutos rojos pastel	10	1000
10202919	1200089	Sorbete de manzana pastel	10	1000
10202920	1200088	Menta dulce pastel	10	1000
10202921	1200026	Gris plata pastel	10	1000



Rotulador fibra 1200 Estuche de 16 + 4 gratis

Código	Ref.	Colores	U/Vta	U/Emb
10202510	E1200/20 S	Vivos	1	8
10202922	E1200/20S P	Pastel	1	8



Rotulador fibra 1200 Estuche portatodo de 14 (12 + 2 pastel)

Código	Ref.	U/Vta	U/Emb
10202924	1200/14S BTS 12+2 PA	1	1



10 x 17 colores
5 x 3 colores
10 x 5 colores pastel
5 x 1 color pastel
10 x 4 colores neón
10 x 2 colores metálicos
5 x 4 colores metálicos

Rotulador fibra 1200 Expositor de 320

Código	Ref.	U/Vta	U/Emb
10204977	4-71200	1	10



Rotulador fibra pastel 1200 Estuche de 6

Código	Ref.	U/Vta	U/Emb
10202923	1200/6S Pastel	1	1



Expositor 1200 Metallic
Expositor de 50 unidades

Código	Ref.	U/Vta	U/Emb
10201685	51151	1	1

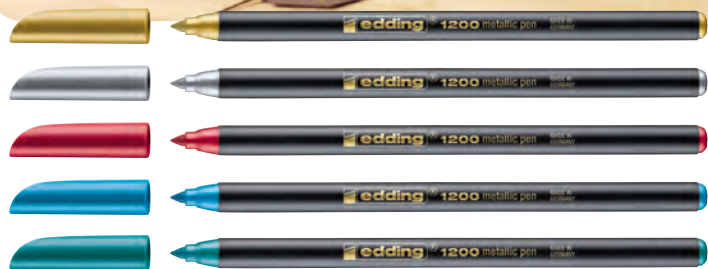

Rotulador fibra 1200 Metallic, trazo 1-3 mm

Código	Ref.	Artículo	U/Vta	U/Emb
10205369	120053	Oro	10	800
10205370	120054	Plata	10	800
10205371	120072	Rojo	10	800
10205372	120073	Azul	10	800
10205373	120074	Verde	10	800
10205374	120078	Violeta	10	800
10205375	1200MET6	Estuche de 6	1	1

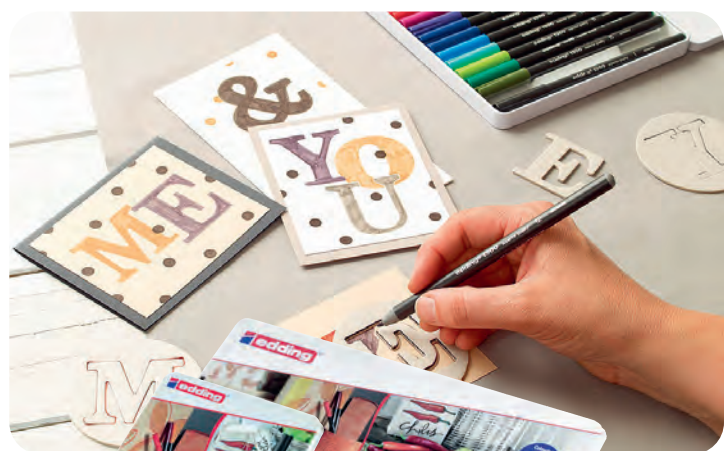

Rotulador fibra 1300 caja de metal

Código	Ref.	Artículo	U/Vta	U/Emb
10211788	130010S	Caja de 10	1	48
10205213	130020S	Caja de 20	1	24
10205214	130040S	Caja de 40	1	12

Rotulador fibra 1300

Código	Ref.	Artículo	U/Vta	U/Emb	Código	Ref.	Color	U/Vta	U/Emb
10205008	130001	Negro	10	1000	10202511	1300021	Gris oscuro	5	1000
10205009	130002	Rojo	10	1000	10202512	1300022	Amarillo limón	5	1000
10205007	130003	Azul	10	1000	10202513	1300025	Verde botella	5	1000
10205010	130004	Verde	10	1000	10202514	1300026	Gris plata	5	1000
10205301	130005	Amarillo	10	1000	10202515	1300027	Marrón oliva	5	1000
10205302	130006	Naranja	10	1000	10202516	1300028	Rojo Inglés	5	1000
10205303	130007	Marrón	10	1000	10202517	1300029	Azul prusiano	5	1000
10205304	130008	Violeta	10	1000	10202518	1300030	Rosa palo	5	1000
10205305	130009	Rosa	10	1000	10202519	1300031	Violeta claro	5	1000
10205306	130010	Azul claro	10	1000	10202520	1300032	Verde laurel	5	1000
10205307	130011	Verde claro	10	1000	10202521	1300034	Verde pálido	5	1000
10205265	130012	Gris	10	1000	10202522	1300035	Coral	5	1000
10211780	130013	Ocre	5	1000	10202523	1300036	Azul manganeso	5	1000
10211781	1300014	Azul turquesa	5	1000	10202088	1300038	Gris beige	5	1000
10211782	1300015	Verde oliva	5	1000	10202524	1300040	Gris castaño	5	1000
10211783	1300016	Naranja claro	5	1000	10202525	1300041	Gris azulado	5	1000
10211784	1300017	Azul acero	5	1000	10202526	1300043	Amarillo brillante	5	1000
10211785	1300018	Marrón oscuro	5	1000	10202527	1300045	Sepia	5	1000
10211786	1300019	Carmin	5	1000	10202528	1300046	Carmesí	5	1000
10211787	1300020	Magenta	5	1000	10202529	1300048	Verde hoja	5	1000



Marcador de flúor 7 mini
Estuche de 4 colores (amarillo, naranja, rosa y verde)

Código	Ref.	U/Vta	U/Emb
10201092	7/4S	1	20



Marcador permanente 400
Punta redonda. Trazo 1 mm rellenable

Código	Ref.	Artículo	U/Vta	U/Emb
10205098	40001	Negro	10	500
10205099	40002	Rojo	10	500
10205097	40003	Azul	10	500
10205300	40004	Verde	10	500



Marcador permanente 300 rellenable
Punta redonda. Trazo de 1,5 - 3mm

Código	Ref.	Artículo	U/Vta	U/Emb
10205220	30001	Negro	10	400
10205268	30002	Rojo	10	400
10205263	30003	Azul	10	400
10205284	30004	Verde	10	400
10204634	30005	Amarillo	10	400
10204637	30006	Naranja	10	400
10204635	30007	Marrón	10	400
10204638	30008	Violeta	10	400
10204636	30009	Rosa	10	400
10204639	30010	Azul claro	10	400
10205473	4-70300	Expositor de 96	1	1



Marcador permanente 330
Punta biselada. Trazo de 1 - 5mm

Código	Ref.	Artículo	U/Vta	U/Emb
10205296	33001	Negro	10	400
10205297	33002	Rojo	10	400
10205291	33003	Azul	10	400
10205298	33004	Verde	10	400
10205292	33005	Amarillo	10	400
10204641	33006	Naranja	10	400
10205425	33007	Marrón	10	400
10204642	33008	Violeta	10	400
10204640	33009	Rosa	10	400
10204643	33010	Azul claro	10	400



Marcador permanente 300 punta redonda
Expositor de 24 unidades

Código	Ref.	U/Vta	U/Emb
10202455	522001	1	1



Marcador permanente 400 punta redonda
Expositor de 30 unidades

Código	Ref.	U/Vta	U/Emb
10202414	52201	1	1



- 3x Negro
- 1x Rojo tráfico mate
- 1x Azul genciana mate
- 1x Verde musgo mate
- 1x Amarillo tráfico mate
- 1x Magenta mate
- 1x rosa pastel mate
- 1x Amarillo pastel mate
- 1x Azul pastel mate
- 1x Verde pastel mate
- 3x Blanco tráfico mate
- 2x Plata mate
- 2x Oro rico mate
- 1x Cobre precioso
- 1x Verde neón mate
- 1x Amarillo neón mate
- 1x Naranja neón mate
- 1x Rosa neón mate

Pintura acrílica permanent spray 200ml
Expositor de 24

Código	Ref.	U/Vta	U/Emb
23501897	4-51642DS	1	1



Marcador 780 tinta opaca permanente, trazo 0,8 mm

Código	Ref.	Artículo	U/Vta	U/Emb
10205460	780-01	Negro	10	600
10205270	780-02	Rojo	10	600
10205271	780-03	Azul	10	600
10201155	780-04	Verde	10	600
10205368	780-55	Cobre	10	600
10205102	78049	Blanco	10	600
10205028	78053	Oro	10	600
10205023	78054	Plata	10	600
10204776	78070	Azul claro metálico	10	600
10204777	78074	Verde metálico	10	600
10204778	78078	Violeta metálico	10	600



Marcador 751 tinta opaca permanente, punta redonda, trazo 1-2 mm

Código	Ref.	Color	U/Vta	U/Emb
10205190	75101	Negro	10	600
10205191	75102	Rojo	10	600
10205105	75149	Blanco	10	600
10205192	75103	Azul	10	600
10205194	75105	Amarillo	10	600
10205195	75106	Naranja	10	600
10205103	75154	Plata	10	600
10205104	75153	Oro	10	600
10205455	75170	Azul claro metálico	10	600
10205456	75174	Verde metálico	10	600
10205457	75178	Violeta metálico	10	600
10205458	75179	Rosa metálico	10	600
10204781	751-999	Caja de 10	1	10



Marcador 751/780 tinta opaca permanente Expositor de 44

Código	Ref.	U/Vta	U/Emb
10204779	51303	1	1



Rotulador fibra 1340 Brushpen punta de pincel Estuche de 10 unidades

Código	Ref.	U/Vta	U/Emb
10202550	e1340/10 S	1	10



Rotulador fibra 1340 Brushpen Happy Box de 20 unidades

Código	Ref.	U/Vta	U/Emb
10202551	CH20+1	1	1



Rotulador fibra 1340 Brushpen, punta de pincel

Código	Ref.	Color	U/Vta	U/Emb
10202530	1340001	Negro	10	800
10202531	1340002	Rojo	10	800
10202532	1340003	Azul	10	800
10202533	1340004	Verde	10	800
10202534	1340005	Amarillo	10	800
10202535	1340006	Naranja	10	800
10202536	1340007	Marrón	10	800
10202537	1340008	Violeta	10	800
10202538	1340009	Rosa	10	800
10202539	1340010	Azul claro	10	800
10202540	1340011	Verde claro	10	800
10202541	1340013	Ocre	10	800
10202542	1340014	Turquesa	10	800
10202543	1340016	Naranja claro	10	800
10202544	1340026	Gris plata	10	800
10202545	1340082	Albarícoque	10	800
10202546	1340083	Melón	10	800
10202547	1340084	Mandarina	10	800
10202548	1340085	Azul celeste	10	800
10202549	1340086	Papaya	10	800



Rotulador fibra 1340 Brushpen, punta de pincel Pack de 6 colores metálicos

Código	Ref.	U/Vta	U/Emb
10204857	104-1340-6	1	10



Rotulador fibra 1340 Brushpen punta de pincel Expositor de 10 estuches

Código	Ref.	U/Vta	U/Emb
10202484	51150	1	1



Rotulador 4500 para Tela, trazo 2-3 mm

Código	Ref.	Color	U/Vta	U/Emb
10205273	450001	Negro	10	400
10205288	450002	Rojo	10	400
10205026	450003	Azul	10	400
10205404	450004	Verde	10	400
10205405	450005	Amarillo	10	400
10205406	450006	Naranja	10	400
10205407	450007	Marrón	10	400
10205408	450008	Violeta	10	400
10205409	450009	Rosa	10	400
10205410	450010	Azul Claro	10	400
10205411	450011	Verde Claro	10	400
10205412	450012	Gris	10	400
10205413	450016	Naranja Claro	10	400
10205414	450019	Carmin	10	400
10205415	450033	Azul Oriental	10	400
10205416	450034	Verde pálido	10	400
10205417	450065	Amarillo Neón	10	400
10205418	450066	Naranja Neón	10	400
10205419	450068	Violeta Neón	10	400
10205420	450069	Rosa Neón	10	400



Marcador textil 4500 para tela, Estuche de colores surtidos

Código	Ref.	Color	Blister	U/Vta	U/Emb
10205376	45005S	Básicos	5 uds	1	40
10202911	4500-5-S-999	Cálidos	5 uds	1	40
10202910	4500-5-S-099	Frios	5 uds	1	40
10204775	4500-999	Básicos	10 uds	1	40



Marcador Textil 4600 (fino) para tela, trazo 1 mm

Código	Ref.	Color	U/Vta	U/Emb
10207132	460001	Negro	10	800
10207133	460002	Rojo	10	800
10207134	460003	Azul	10	800
10207135	460004	Verde	10	800
10207136	460005	Amarillo	10	800
10205253	460006	Naranja	10	800
10207137	460007	Marrón	10	800
10207138	460008	Violeta	10	800
10207139	460009	Rosa	10	800
10207140	460010	Azul Claro	10	800
10207141	460011	Verde Claro	10	800
10207142	460012	Gris	10	800
10205252	460016	Naranja Claro	10	800
10205248	460019	Carmin	10	800
10207143	460033	Azul Oriental	10	800
10207144	460034	Verde pálido	10	800
10205244	460065	Amarillo Neón	10	800
10205251	460066	Naranja Neón	10	800
10207145	460068	Violeta Neón	10	800
10205257	460069	Rosa Neón	10	800
10205286	50445	Expositor de 10 estuches con 10 colores surtidos	1	1



Marcador textil 4600 (fino) para tela, Estuche de 5 colores surtidos

Código	Ref.	Color	U/Vta	U/Emb
10202913	4600-5-S	Básicos	1	1
10202915	4600-5-S-999	Cálidos	1	1
10202914	4600-5-S-099	Frios	1	1

Marcador textil 4600 (fino) para tela, Estuche de 10 colores surtidos

Código	Ref.	Color	U/Vta	U/Emb
10202984	4600-10-999	Básicos	1	1
10202912	4600-10-099	Frios	1	1

Marcador textil 4500 Expositor surtido de 60

Código	Ref.	U/Vta	U/Emb
10205147	50441	1	1



Rotulador marcador tiza líquida 4090
Punta biselada. Trazo 4 - 15mm

Código	Ref.	Color	U/Vta	U/Emb
10210116	409001	Negro	5	100
10210156	409002	Rojo	5	100
10210157	409003	Azul	5	100
10205402	409004	Verde	5	100
10210158	409011	Verde Claro	5	100
10205403	409049	Blanco	5	100
10210159	409065	Amarillo Neón	5	100
10205295	409066	Naranja Neón	5	100
10210160	409069	Rosa Neón	5	100
10204774	409007	Marrón	5	100

Marcador tiza líquida 4090 punta biselada
Blister de 5

Código	Ref.	Color	U/Vta	U/Emb
10204651	4090-099	○ ● ● ● ● ●	1	2
10204650	4090-999	● ● ● ● ● ●	1	2



20x 4090
24x 4095

Marcador tiza líquida
Expositor de 44

Código	Ref.	U/Vta	U/Emb
10202627	50533	1	1



Rotulador 4095 tiza líquida cónico
Punta redonda. Trazo 2-3 mm

Código	Ref.	Color	U/Vta	U/Emb
10205275	409501	Negro	10	400
10205400	409502	Rojo	10	400
10205401	409503	Azul	10	400
10205359	409504	Verde	10	400
10205361	409511	Verde Claro	10	400
10205362	409549	Blanco	10	400
10205363	409565	Amarillo Neón	10	400
10205364	409566	Naranja Neón	10	400
10205365	409569	Rosa Neón	10	400



Rotulador 95 para cristal punta redonda
Blister de 4

Código	Ref.	Color	U/Vta	U/Emb
10204786	95-999	○ ● ● ● ● ●	1	2
10204787	95-099	● ● ● ● ● ●	1	2



Marcador tiza líquida 4095
Estuche de 5

Código	Ref.	U/Vta	U/Emb
10209136	40955999	1	1



Rotulador para cristal 95
Estuche de 6

Código	Ref.	U/Vta	U/Emb
10204348	95-6-S	1	1



Rotulador para cristal 95 punta redonda

Código	Ref.	Color	U/Vta	U/Emb
10204785	95-49	Blanco	10	10
10204784	95-01	Negro	10	10
10204769	95-05	Amarillo	10	10
10204770	95-06	Naranja	10	10
10204771	95-09	Rosa	10	10
10204772	95-10	Azul claro	10	10



Marcador Acrylic 5300
Punta redonda. Trazo de 1 - 2mm

Código	Ref.	Color	U/Vta	U/Emb
10203681	5300-922	Blanco	10	10
10203682	5300-901	Negro	10	10
10203683	5300-924	Oro	10	10
10203684	5300-923	Plata	10	10
10203685	5300-902	Rojo tráfico	10	10
10203686	5300-906	Amarillo sol	10	10
10203687	5300-905	Amarillo tráfico	10	10
10203688	5300-927	Verde limón	10	10
10203689	5300-934	Turquesa	10	10
10203690	5300-903	Azul genciana	10	10
10203691	5300-935	Malva	10	10
10203692	5300-910	Arándano	10	10
10203693	5300-926	Antracita	10	10
10203694	5300-919	Avellana	10	10
10203695	5300-916	Azul pastel	10	10
10203696	5300-917	Verde pastel	10	10
10203697	5300-255	Beige cálido	10	10
10203698	5300-065	Amarillo neón	10	10
10203699	5300-066	Naranja neón	10	10
10203700	5300-069	Rosa neón	10	10



Marcador Acrylic 5100
Punta redonda. Trazo de 2 - 3 mm

Código	Ref.	Color	U/Vta	U/Emb
10203706	5100-922	Blanco	10	10
10203707	5100-901	Negro	10	10
10203708	5100-924	Oro	10	10
10203709	5100-923	Plata	10	10
10203710	5100-902	Rojo tráfico	10	10
10203711	5100-906	Amarillo sol	10	10
10203712	5100-905	Amarillo tráfico	10	10
10203713	5100-927	Verde limón	10	10
10203714	5100-904	Verde musgo	10	10
10203715	5100-928	Menta suave	10	10
10203716	5100-934	Turquesa	10	10
10203717	5100-903	Azul genciana	10	10
10203718	5100-933	Azul noche	10	10
10203719	5100-935	Malva	10	10
10203720	5100-909	Magenta	10	10
10203721	5100-910	Arándano	10	10
10203722	5100-926	Antracita	10	10
10203723	5100-919	Avellana	10	10
10203724	5100-907	Chocolate	10	10
10203725	5100-915	Amarillo pastel	10	10
10203726	5100-916	Azul pastel	10	10
10203727	5100-917	Verde pastel	10	10
10203728	5100-255	Beige cálido	10	10
10203729	5100-065	Amarillo neón	10	10
10203730	5100-066	Naranja neón	10	10
10203731	5100-069	Rosa neón	10	10



Marcador Acrylic
Expositor surtido de 18

Código	Ref.	U/Vta	U/Emb
10203703	52449	1	1



Marcador Acrylic
Expositor de 9 estuches de 8 uds (SES8N)

Código	Ref.	U/Vta	U/Emb
10203704	52448	1	1



Marcador Acrylic 5100
Punta redonda. Trazo de 2 - 3 mm
Pack de 5

Código	Ref.	Color	U/Vta	U/Emb
10203733	5100-5-S	Básicos	10	10
10203732	5100-5-S-099	Pastel	10	10
10203734	5100-5-S-999	Festivos	10	10

1x 5300 blanco
1x 5300 negro
1x 5000 menta
1x 5000 azul noche
1x 5000 malva
1x 5000 amar. past.
1x 5000 arándano
1x 5000 verde musgo



Marcador Acrylic
Pack surtido de 8

Código	Ref.	U/Vta	U/Emb
10203701	SES8N	1	10



Marcador Acrylic
Pack surtido de 12

Código	Ref.	U/Vta	U/Emb
10203702	CS12B	10	10

2x 5300
6x 5100
3x 5000
1x 5400



Marcador Acrylic
Expositor de 224

Código	Ref.	U/Vta	U/Emb
10203705	52445	1	1

66x 5300
80x 5100
48x 5000
30x 5400



Marcador Acrylic 5000
Punta biselada. Trazo de 5 - 10mm

Código	Ref.	Color	U/Vta	U/Emb
10203735	5000-922	Blanco	5	5
10203736	5000-901	Negro	5	5
10203737	5000-924	Oro	5	5
10203738	5000-923	Plata	5	5
10203739	5000-902	Rojo tráfico	5	5
10203740	5000-906	Amarillo sol	5	5
10203741	5000-905	Amarillo tráfico	5	5
10203742	5000-927	Verde limón	5	5
10203743	5000-904	Verde musgo	5	5
10203744	5000-928	Menta suave	5	5
10203745	5000-934	Turquesa	5	5
10203746	5000-903	Azul genciana	5	5
10203747	5000-933	Azul noche	5	5
10203748	5000-935	Malva	5	5
10203749	5000-909	Magenta	5	5
10203750	5000-910	Arándano	5	5
10203751	5000-926	Antracita	5	5
10203752	5000-919	Avellana	5	5
10203753	5000-907	Chocolate	5	5
10203754	5000-915	Amarillo pastel	5	5
10203755	5000-916	Azul pastel	5	5
10203756	5000-917	Verde pastel	5	5
10203757	5000-255	Beige cálido	5	5
10203758	5000-065	Amarillo neón	5	5
10203759	5000-066	Naranja neón	5	5
10203760	5000-069	Rosa neón	5	5



Marcador Acrylic 5000
Punta biselada. Trazo de 5 - 10mm
Pack de 5

Código	Ref.	Color	U/Vta	U/Emb
10203761	5000-5-S-999	Abstracto	1	20
10203762	5000-5-S	Neón	10	20



Marcador Acrylic 5400 3D
doble punta 2-3/5-10mm

Código	Ref.	Color	U/Vta	U/Emb
10203763	5400-922	Blanco	5	5
10203764	5400-901	Negro	5	5
10203765	5400-924	Oro	5	5
10203766	5400-923	Plata	5	5
10203767	5400-902	Rojo tráfico	5	5
10203768	5400-906	Amarillo sol	5	5
10203769	5400-905	Amarillo tráfico	5	5
10203770	5400-927	Verde limón	5	5
10203771	5400-904	Verde musgo	5	5
10203772	5400-928	Menta suave	5	5
10203773	5400-934	Turquesa	5	5
10203774	5400-903	Azul genciana	5	5
10203775	5400-933	Azul noche	5	5
10203776	5400-935	Malva	5	5
10203777	5400-909	Magenta	5	5
10203778	5400-910	Arándano	5	5
10203779	5400-926	Antracita	5	5
10203780	5400-919	Avellana	5	5
10203781	5400-907	Chocolate	5	5
10203782	5400-915	Amarillo pastel	5	5
10203783	5400-916	Azul pastel	5	5
10203784	5400-917	Verde pastel	5	5
10203785	5400-255	Beige cálido	5	5
10203786	5400-065	Amarillo neón	5	5
10203787	5400-066	Naranja neón	5	5
10203788	5400-069	Rosa neón	5	5



Marcador Acrylic 5400 3D
doble punta 2-3/5-10mm
Pack surtido de 5

Código	Ref.	U/Vta	U/Emb
10203789	5400-5-S	1	20



Bolígrafo retráctil InkJoy 100

Código	Ref.	Color	U/Vta	U/Emb
10101632	S0957030	Negro	20	50
10101633	S0957040	Azul	20	50
10101634	S0957050	Rojo	20	50



Bolígrafo InkJoy 100 Cap

Código	Ref.	Color	U/Vta	U/Emb
10101576	S0957120	Negro	50	50
10101577	S0957130	Azul	50	50
10101578	S0957140	Rojo	50	50
10101648	S0975420	Fantasia	12	12



Bolígrafo retráctil InkJoy 300 RT

Código	Ref.	Color	U/Vta	U/Emb
10101650	S0959910	Negro	12	12
10101651	S0959920	Azul	12	12



Bolígrafo InkJoy gel retráctil

Código	Ref.	Color	U/Vta	U/Emb
10101098	1957054	Azul	12	12
10101097	1957053	Negro	12	12
10101100	1957056	Rojo	12	12



Bolígrafo de 4 colores InkJoy Cuatro

Código	Ref.	Color	U/Vta	U/Emb
10101667	S0977260	● ● ● ●	12	12
10101666	S0977270	● ● ● ●	12	12



Corrector bolígrafo NP10 7ml punta metal

Código	Ref.	U/Vta	U/Emb
15103019	2037843	12	12

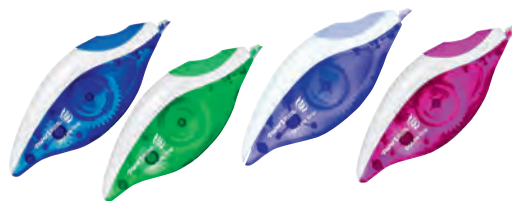

Corrector casete Dryline Grip 8,5m colores

Código	Ref.	U/Vta	U/Emb
15103012	1862885	12	144



Bolígrafo InkJoy gel Blíster de 14

Código	Ref.	U/Vta	U/Emb
10101389	1985481	1	12



Rotulador de fibra Flair Bold mate grueso Blíster de 12

Código	Ref.	U/Vta	U/Emb
10203851	2138474	1	12



Rotulador de fibra Flair mate Blíster de 12

Código	Ref.	Artículo	U/Vta	U/Emb
10203847	1985616	Candy Pop	1	12
10203848	1951029	Tropical Vacation	1	12
10203850	2048987	Básicos	1	12
10203852	2137277	Pastel	1	12



Rotulador fibra Flair colores metálicos

Código	Ref.	Estuche	U/Vta	U/Emb
10204767	2137361	6 uds	1	12
10204768	2137362	12 uds	1	12



Rotulador de fibra Flair Blíster surtido de 20

Código	Ref.	U/Vta	U/Emb
10204341	2161989	1	12

8x Flair M
8x Flair Bold
4x Flair UF

Sharpie



Marcador creativo líquida S Note biselado
Blíster de 12

Código	Ref	U/Vta	U/Emb
10203853	2138233	1	11



Rotulador permanente Fine

Código	Ref.	Color	U/Vta	U/Emb
10207050	S0810930	Negro	12	12
10207049	S0810950	Azul	12	12
10207051	S0810940	Rojo	12	12
10207052	S0810960	Verde	12	12
10202885	2061128	Surtido de 20	1	12



Rotulador permanente Fine & Ultrafine Big Pack

Código	Ref.	Artículo	Estuche	U/Vta	U/Emb
10204789	2158030	Lobo	26 uds	12	12
10204790	2158181	Fold	30 uds	12	12



Rotulador permanente Mystic Gems fine

Código	Ref.	Estuche	U/Vta	U/Emb
10204342	2157670	5 uds	12	144
10204343	2157681	12 uds	12	144



Marcador de tiza líquida Chalk Marker

Código	Ref.	Color	Estuche	U/Vta	U/Emb
10204819	2157734	Blanco	2 uds	12	12
10204820	2157733	Surtidos	5 uds	12	12



Bolígrafo gel 0,7mm

Código	Ref.	Color	U/Vta	U/Emb
10101367	2136600	Azul	12	12
10101366	2136595	Negro	12	12
10101368	2136599	Rojo	12	12



Bolígrafo gel Fashion 0,7mm tinta azul
Caja de 12 (6 azul y 6 blanco)

Código	Ref.	U/Vta	U/Emb
10101420	2162641	1	12



Cola lavable Slime 147ml

• **Translúcida**

Código	Ref	Artículo	U/Vta	U/Emb
23101292	2109485	Azul	3	3
23101294	2109496	Rosa	3	3

• **Metálica**

Código	Ref	Artículo	U/Vta	U/Emb
23101300	2109503	Azul	3	3
23101301	2109508	Rosa	3	3
23101302	2109493	Verde azulado	3	3

• **Brilla en la oscuridad**

Código	Ref	Artículo	U/Vta	U/Emb
23101426	2162078	Azul	3	3
23101427	2162079	Rosa	3	3
23101428	2162077	Natural	3	3



2x Pegamento transp. 118ml
2x Líquido mágico 68ml
4x Pegamento purpurina



Juego Slime purpurina Starter Pack Kit completo

Código	Ref	U/Vta	U/Emb
25901347	2050943	1	4



2x Pegamento cambiador 147ml
2x Líquido mágico 68ml

Juego Slime Starter Pack Kit completo

Código	Ref	Artículo	U/Vta	U/Emb
23101305	2109483	Metálicos	1	3
23101306	2109487	Cambiador	1	3



Cola líquido mágico activador Slime 259ml

Código	Ref	Artículo	U/Vta	U/Emb
23101290	2109495	Confetti	6	6
23101291	2109490	Crunchi	6	6



Roller Xtra 825 0,5mm

Código	Ref	Color	U/Vta	U/Emb
10101387	SH182503	Azul	10	10
10101385	SH182501	Negro	10	10
10101386	SH182502	Rojo	10	10
10101388	SH182504	Verde	10	10

Roller tinta líquida
One Hybrid punta de aguja de 0,5mm
Expositor surtido de 30

Código	Ref.	U/Vta	U/Emb
11201207	SH304782	1	1



Bolígrafo Slider Rave XB
Expositor surtido de 30

Código	Ref.	U/Vta	U/Emb
10101269	SH304022	1	1



Rotulador de fibra Pictus

Código	Ref	Descripción	U/Vta	U/Emb
10204293	SH197598	Estuche de 8	1	1
10204294	SH306002	Expositor de 144	1	1



Bolígrafo Slider Edge Pastel
Expositor surtido de 120

Código	Ref.	U/Vta	U/Emb
10101331	SH305502	1	1



Bolígrafo K-15 M
Expositor surtido de 216

Código	Ref.	U/Vta	U/Emb
10101274	SH305052	1	1



Marcador flúor Job
Expositor surtido de 55

Código	Ref	Color	U/Vta	U/Emb
10204997	SH306292	Vivos	1	1
10204998	SH306302	Pastel	1	1



Marcador permanente Maxx 130 cónico

Código	Ref	Color	U/Vta	U/Emb
10202819	SH113003	Azul	10	400
10202817	SH113001	Negro	10	400
10202818	SH113002	Rojo	10	400
10202820	SH113004	Verde	10	400

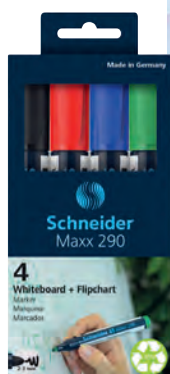
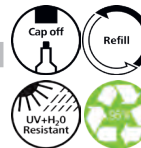

Marcador de pizarra Maxx 290 cónico
Estuche de 4

Código	Ref.	U/Vta	U/Emb
10203500	SH129094	1	1



Tinta estilográfica
Caja de 6 cartuchos

Código	Ref	Color	U/Vta	U/Emb
10601261	SH6601	Negro	1	10
10601262	SH6603	Azul	1	10
10601283	SH6602	Rojo	1	10



Recambio
Expositor surtido de 170

Código	Ref.	U/Vta	U/Emb
25401578	SH2844	1	1



El marcador fluorescente n.º 1 en Europa



Marcador fluorescente Boss 70

Código	Ref	Color	U/Vta	U/Emb	Código	Ref	Color	U/Vta	U/Emb
10202044	70/24	Amarillo Original	10	500	10201157	70/113	Turquesa Pastel	10	500
10202304	70/31	Azul Original	10	500	10201158	70/116	Menta Pastel	10	500
10202307	70/58	Lila Original	10	500	10203390	70/133	Chispa de lima	10	500
10202046	70/54	Naranja Original	10	500	10203391	70/150	Rosa cerezo en flor	10	500
10202306	70/40	Rojo Original	10	500	10203392	70/111	Azul nublado	10	500
10202305	70/56	Rosa Original	10	500	10203393	70/140	Coral meloso	10	500
10202409	70/51	Turquesa Original	10	500	10203582	70/125	Naranja pálido	10	500
10202045	70/33	Verde Original	10	500	10203583	70/112	Azul ventoso	10	500
10202002	70/55	Violeta Original	10	500	10203584	70/158	Fucsia helado	10	500
10201161	70/144	Amarillo Pastel	10	500	10203585	70/194	Gris polvoriento	10	500
10201159	70/126	Melocotón Pastel	10	500	10202255	70/45-1	Exp. de 45 Original	1	1
10201160	70/129	Rosa Pastel	10	500	10202254	70/45-4	Exp. de 45 Pastel	1	1
10201156	70/155	Lila Pastel	10	500	10202580	70/120-2	Exp. de 120 Original	1	1



Marcador fluorescente Boss Original Pastel Bombonera de 60 unidades

Código	Ref	U/Vta	U/Emb
10203402	70/60-04	1	1



Set de mesa Marcador flúor Boss 70

Código	Ref	Estuche	U/Vta	U/Emb
10202125	7015-01	15 uds (9 fluo + 6 pastel)	1	10
10203581	7023-01-5	23 uds (9 fluo + 14 pastel)	5	10



Marcador fluorescente Boss Original

Código	Ref	Estuche	U/Vta	U/Emb
10203397	70/8-3	8 uds	1	5
10201163	70/6-2	6 uds	1	5
10201162	70/4-2	4 uds	1	5
10203400	70/4-3	4 uds	1	5
10203586	70/4-4	4 uds	5	5
10203656	70/4-33	4 uds	1	5



Marcador fluorescente Boss Mini

Código	Ref	Color	U/Vta	U/Emb
10204241	07/3-2-02		10	180
10204242	07/5-2-01		10	100



Marcador flúor Boss 70 Arty Line Set de mesa de 23

Código	Ref	U/Vta	U/Emb
10204227	7023-01-5-20	1	1



Marcador flúor Boss 70 Arty Line

Código	Ref	Colores	Estuche	U/Vta	U/Emb
10204223	70/5-02-1-20	Cálidos	5 uds	1	5
10204224	70/5-02-2-20	Fríos	5 uds	1	5
10204225	70/10-1-20	Cálidos	10 uds	1	5
10204226	70/10-2-20	Fríos	10 uds	1	5



Marcador fluorescente Boss 70 pastel by Ju Schnee

Código	Ref	Color	U/Vta	U/Emb
10204878	70/111-101	Azul nublado	10	100
10204879	70/116-101	Pizza de menta	10	100
10204880	70/125-101	Naranja pálido	10	100
10204881	70/158-101	Fucsia helado	10	100
10204882	70/4-1-101-5	Estuche de 4	1	5



Marcador fluorescente Boss 70 pastel by Ju Schnee Bombonera de 30

Código	Ref	U/Vta	U/Emb
10204883	70/30-2-101	1	1



Marcador fluorescente Boss 70 pastel by Ju Schnee Expositor de 30

Código	Ref	U/Vta	U/Emb
10204884	70/30-1-101	1	1



Marcador fluorescente Boss Mini by Sooze One

Código	Ref	Color	U/Vta	U/Emb
10204885	07/24-10	Amarillo "Pocket full dreams"	10	10
10204886	07/31-10	Azul "Stay in the flow"	10	10
10204887	07/33-10	Verde "Small world big plans"	10	10
10204888	07/54-10	Naranja "Stay true"	10	10
10204889	07/56-10	Rosa "Rise"	10	10
10204890	07/46-10	Negro "Bam"	10	10



Marcador fluorescente Boss Mini by Sooze One

Código	Ref	Estuche	U/Vta	U/Emb
10204891	07/03-61	3 uds	10	10
10204892	07/03-71	3 uds	10	10
10204893	07/05-30-10	5 uds	10	10
10204894	07/06-30	6 uds	10	10



Marcador fluorescente Boss Mini by Sooze One Bombonera de 50

Código	Ref.	U/Vta	U/Emb
10204895	07/50-10	1	1



Marcador fluorescente Boss 70 Snooze One Set de mesa de 23 (9 flúor + 14 pastel)

Código	Ref.	U/Vta	U/Emb
10204877	7023-01-06	1	5



Marcador fluorescente Boss Mini by Sooze One Expositor de 16

Código	Ref.	U/Vta	U/Emb
10204896	07/72-10	1	1



Marcador flúor Swing Cool Pastel 275

Código	Ref	Color	U/Vta	U/Emb
10202284	275/126-8	Melocotón	10	500
10202285	275/116-8	Menta	10	500
10202286	275/129-8	Rosa	10	500
10202287	275/113-8	Turquesa	10	500
10202288	275/155-8	Violeta	10	500
10203790	275/133-8	Chispa de lima	10	500
10203791	275/150-8	Rosa cerezo flor	10	500
10203792	275/111-8	Azul nublado	10	500
10203793	275/140-8	Coral meloso	10	500
10204251	275/112-8	Azul ventoso	10	500
10204252	275/125-8	Naranja pálido	10	500
10204253	275/158-8	Fucsia helado	10	500
10204254	275/194-8	Gris polvoriento	10	500
10202289	275/4-08	Estuche de 4	1	10
10202290	275/6-08	Estuche de 6	1	10



Marcador flúor Swing Cool Pastel 275 Set de bolsillo

Código	Ref	Artículo	U/Vta	U/Emb
10204255	275/4-08-2	4 uds	5	5
10203825	275/4-08-1	4 uds	5	5
10204256	275/8-08-2	8 uds	5	5
10203826	275/8-08-1	8 uds	5	5
10203589	275/18-01-5	18 uds	5	5



Marcador flúor Swing Cool Pastel 275 Bombonera de 100 (10 colores surtidos)

Código	Ref	U/Vta	U/Emb
10203827	275/100-8-2	1	1



Marcador flúor Swing Cool Pastel 275 Expositor surtido de 48

Código	Ref	U/Vta	U/Emb
10202292	275/48-8-2	1	1



Rotulador fluorescente NEON 72

Código	Ref	Color	U/Vta	U/Emb
10202712	72/24	Amarillo	10	10
10202715	72/33	Verde	10	10
10202714	72/54	Naranja	10	10
10202713	72/56	Rosa	10	10
10202768	72/58	Magenta	10	10
10202256	72/45-1	Expositor de 45	1	1

POINT 88

Rotulador de fibra punta fina Point 88

Código	Ref	Color	U/Vta	U/Emb	Código	Ref	Color	U/Vta	U/Emb
10201886	88/024	Amarillo neón	10	10	10210043	88/58	Lila	10	10
10201887	88/033	Verde neón	10	10	10210051	88/59	Lila claro	10	10
10201888	88/040	Rojo neón	10	10	10210044	88/63	Verde oliva	10	10
10201889	88/054	Naranja neón	10	10	10210045	88/89	Ocre oscuro	10	10
10201890	88/056	Rosa neón	10	10	10210046	88/94	Gris claro	10	10
10210032	88/13	Verde hielo	10	10	10210047	88/96	Gris oscuro	10	10
10210052	88/22	Azul noche	10	10	10203829	88/12	Eucalpto	10	10
10210048	88/26	Albaricoque	10	10	10203830	88/28	Colorete	10	10
10210033	88/32	Ultramarino	10	10	10203831	88/34	Pistacho	10	10
10210049	88/33	Verde manzana	10	10	10203832	88/37	Verde barro	10	10
10210024	88/36	Verde	10	10	10203833	88/47	Rojo óxido	10	10
10210023	88/40	Rojo	10	10	10203834	88/49	Rojo fresca	10	10
10210020	88/41	Azul	10	10	10203835	88/60	Ciruela	10	10
10210034	88/43	Verde hoja	10	10	10203836	88/61	Lila grisáceo	10	10
10210035	88/44	Amarillo	10	10	10204228	88/14	Verde lima	10	10
10210036	88/45	Marrón	10	10	10204229	88/23	Amarillo claro	10	10
10210022	88/46	Negro	10	10	10204230	88/25	Naranja claro	10	10
10210037	88/50	Carmesí	10	10	10204231	88/35	Verde musgo	10	10
10210038	88/51	Turquesa	10	10	10204232	88/66	Caqui	10	10
10210050	88/53	Verde pino	10	10	10204233	88/67	Mostaza	10	10
10210039	88/54	Naranja	10	10	10204234	88/85	Papaya	10	10
10210040	88/55	Violeta	10	10	10204235	88/86	Beige	10	10
10210041	88/56	Rosa	10	10	10204236	88/87	Curry	10	10
10210042	88/57	Azul celeste	10	10	10204237	88/93	Gris cálido	10	10

El punta fina líder en Europa

punta encajada en metal = previene roturas

200x rotuladores 6x estuches 88/6 6x estuches vacíos



Rotulador fibra point 88 Expositor de 236 (20 colores)

Código	Ref.	U/Vta	U/Emb
10210008	88/236-1	1	1



Rotulador fibra punta fina Point 88

Código	Ref	Estuche	U/Vta	U/Emb
10201173	88/6-1	6 neón	1	10
10204238	8810-22	10 uds	1	1
10201882	8815-1	10+5 neón	1	10
10204239	8818-22-5	18 uds	1	1
10210134	8820	20 uds	1	1
10201984	8830-1	25+5 neón	1	5

Rotulador fibra Point 88 Estuche de 8

Código	Ref	Color	U/Vta	U/Emb
10201289	88/8-02	Rojos	1	10
10201290	88/8-03	Azules	1	10
10201284	88/8-01	Pastel	1	10

Rotulador fibra Rollerset Point 88 punta fina

Código	Ref	Artículo	U/Vta	U/Emb
10203588	8825-071-20	Arty de 25	1	5
10201880	8830-2	Rollerset de 30	1	1



Rotulador fibra Point 88 Estuche surtido de 20

Código	Ref	U/Vta	U/Emb
10203823	8820-41	5	5



Rotulador fibra Point 88 ColorParade de 20

Código	Ref	U/Vta	U/Emb
10210104	8820-03	1	1



Rotulador fibra Sleeve point 88 Estuche de 30

Código	Ref	U/Vta	U/Emb
10203552	8830-4	5	5



16x Swing Cool
15x Boss 70
40x Point 88
40x Pen 68

Expositor Pastel surtido 111 unidades

Código	Ref	U/Vta	U/Emb
18901273	24/04-2	1	1



Rotulador fibra
Expositor de 480+50 de regalo

Código	Ref	Artículo	U/Vta	U/Emb
10202253	E68/480-1	Pen 68	1	1
10202252	E88/480-1	Point 88	1	1



Rotulador fibra point 88
Caja metálica de 50

Código	Ref	U/Vta	U/Emb
10201292	8850-6	1	1



Rotulador Zebra 20uds
Expositor de 10 cajas

Código	Ref	U/Vta	U/Emb
10210224	8820-10-02	1	1



7x rollersets point 88
5x rollersets pen 68



Rotulador de fibra Point 88 Arty Line
Estuche de cartón de 24

Código	Ref	U/Vta	U/Emb
10203877	8824/1-20	6	6

Rotulador fibra Arty
Expositor surtido de 12

Código	Ref	U/Vta	U/Emb
10203824	25/26-06-1	1	1



Rotulador de fibra Pen 68 Brush

Código	Ref	Color	U/Vta	U/Emb
10203247	568/024	Amarillo fluorescente	10	10
10203252	568/44	Amarillo	10	10
10203253	568/54	Naranja	10	10
10203254	568/48	Carmin	10	10
10203255	568/50	Rojo oscuro	10	10
10203256	568/19	Púrpura	10	10
10203257	568/58	Lila	10	10
10203258	568/55	Violeta	10	10
10203259	568/22	Azul prusia	10	10
10203260	568/32	Ultramarino	10	10
10203261	568/41	Azul oscuro	10	10
10203262	568/33	Verde claro	10	10
10203263	568/43	Verde hoja	10	10
10203264	568/36	Verde esmeralda	10	10
10203265	568/51	Azul turquesa	10	10
10203266	568/89	Ocre oscuro	10	10
10203267	568/26	Albaricoque	10	10
10203268	568/45	Marrón	10	10
10203269	568/95	Gris claro	10	10
10203270	568/46	Negro	10	10
10204097	568/29	Rosa	10	10
10204123	568/30	Bermellón pálido	10	10
10203248	568/31	Azul claro	10	10
10204124	568/34	Pistacho	10	10
10204125	568/37	Verde barro	10	10
10204126	568/47	Rojo óxido	10	10
10204127	568/53	Verde turquesa	10	10
10204137	568/60	Ciruela	10	10
10204140	568/63	Verde tierra	10	10
10204148	568/75	Siena	10	10

PEN 68 BRUSH



Rotulador de fibra Pen 68 Brush
Blíster

Código	Ref	Blíster	U/Vta	U/Emb
10203273	568/06-11	6 uds	1	10
10203274	568/10-11	10 uds	1	10



Rotulador de fibra Pen 68 Brush
Caja de cartón

Código	Ref	Estuche	U/Vta	U/Emb
10203271	568/12-21	12 uds	1	6
10203272	568/24-211	24 uds	1	6

PEN 68

Rotulador Pen 68

Código	Ref	Color	U/Vta	U/Emb	Código	Ref	Color	U/Vta	U/Emb
10201897	68/11	Azul hielo	10	10	10210178	68/56	Rosa	10	10
10201946	68/13	Verde hielo	10	10	10210117	68/57	Azul celeste	10	10
10201910	68/16	Esmeralda claro	10	10	10210119	68/58	Lila	10	10
10201911	68/17	Malva	10	10	10201948	68/63	Verde tierra	10	10
10210120	68/19	Púrpura	10	10	10210127	68/65	Ocre	10	10
10210143	68/22	Azul de Prusia	10	10	10210126	68/75	Siena	10	10
10201898	68/24	Amarillo limón	10	10	10201949	68/88	Ocre claro	10	10
10210125	68/26	Carne claro	10	10	10210176	68/89	Ocre oscuro	10	10
10201899	68/29	Rosa claro	10	10	10210128	68/94	Gris claro	10	10
10201912	68/30	Bermellón pálido	10	10	10210129	68/95	Gris medio	10	10
10201900	68/31	Azul claro	10	10	10210130	68/96	Gris oscuro	10	10
10210140	68/32	Azul marino	10	10	10201901	68/97	Gris intenso	10	10
10210138	68/33	Verde claro	10	10	10201950	68/98	Gris de Payne	10	10
10210146	68/36	Verde	10	10	10203837	68/12	Eucalipto	10	10
10210179	68/38	Sanguina	10	10	10203838	68/28	Colorete	10	10
10210124	68/40	Rojo	10	10	10203839	68/34	Pistacho	10	10
10210144	68/41	Azul oscuro	10	10	10203840	68/37	Verde barro	10	10
10201913	68/43	Verde hoja	10	10	10203841	68/47	Rojo óxido	10	10
10201947	68/44	Amarillo	10	10	10203842	68/49	Rosa fresca	10	10
10210123	68/45	Marrón	10	10	10203843	68/60	Cruela	10	10
10210137	68/46	Negro	10	10	10203844	68/61	Lila grisáceo	10	10
10210148	68/48	Carmín	10	10	10201951	68/024	Amarillo Neón	10	10
10210147	68/50	Rojo oscuro	10	10	10201952	68/031	Azul Neón	10	10
10210145	68/51	Azul turquesa	10	10	10201953	68/033	Verde Neón	10	10
10201118	68/53	Verde turquesa	10	10	10201954	68/040	Rojo Neón	10	10
10210177	68/54	Naranja	10	10	10201955	68/054	Naranja Neón	10	10
10210121	68/55	Violeta	10	10	10201956	68/056	Rosa Neón	10	10
					10210162	68/240	Expositor de 240	1	1

Rotulador de fibra Pen 68 Metallic

Código	Ref	Color	U/Vta	U/Emb
10202793	68/805	Plata	10	10
10202794	68/820	Cobre	10	10
10202795	68/810	Dorado	10	10
10202796	68/841	Azul	10	10
10202797	68/836	Verde	10	10
10203287	68/855	Lila	10	10
10203288	68/856	Rosa	10	10
10203289	68/843	Verde claro	10	10
10203284	6808/8-11	Est. plástico de 8	1	10
10203285	6808/8-31	Est. metálico de 8	1	10
10203286	68/60-8-4	Expositor de 60	1	1

Rotulador fibra Sleeve pen 68
Estuche de 30

Código	Ref	U/Vta	U/Emb
10203555	6830-4	1	5

Rotulador fibra Pen 68
caja plástico de 8 colores pastel

Código	Ref	U/Vta	U/Emb
10201293	68/8-01	1	10

Rotulador fibra Pen 68 Color Parade
Estuche de 20

Código	Ref	Artículo	U/Vta	U/Emb
10203321	6820-04-03	Antracita/rosa	1	5
10203322	6820-04-04	Antracita/azul	1	5

Rotulador fibra Pen 68 Zebrui
Estuche de 20

Código	Ref	Artículo	U/Vta	U/Emb
10201959	6820-02-1-5	Cereza	5	5
10201960	6820-02-2-5	Turquesa	5	5

Rotulador Pen 68 - Big Pen Box

Código	Ref	U/Vta	U/Emb
10201958	6820-1	1	10

Rotulador Pen 68, punta fina
Rollerset Fan Edition de 25u

Código	Ref	U/Vta	U/Emb
10201294	6825-071-20	1	5



Lavables

8 semanas sin tapón

Rotulador Power

Código	Ref	Artículo	U/Vta	U/Emb
10210053	280/12-01	12 uds	1	1
10210083	280/18-01	18 uds	1	1
10210054	980/12-01	12 Max	1	1



Lavables

Rotulador Trio A-Z

Código	Ref	U/Vta	U/Emb
10210096	378/1-12-01	1	1



Rotulador fibra Trio Deco 377

Código	Ref	Artículo	U/Vta	U/Emb
10203277	377/8	Estu. de 8	1	12
10203278	377/96-1	Exp. de 96	1	1



Incluye afila

Lápices de colores Woody Duo 3 en 1

Código	Ref	Estuche	U/Vta	U/Emb
12802297	8826-2	6 uds	5	5
12802298	882/10-2	10 uds	5	5



*Incluye afila

Lápices de colores Woody 3 en 1 pastel Estuche de 5

Código	Ref	Color	U/Vta	U/Emb
12802382	880/201	Amarillo	1	5
12802383	880/301	Rojo	1	5
12802384	880/302	Rosa	1	5
12802385	880/303	Lila	1	5
12802386	880/402	Azul	1	5
12802387	880/503	Verde	1	5
12802388	8806-3	6 uds*	1	5
12802389	880/18-4	18 uds*	1	2
12802368	880/48-3	Exp. 48	1	1



Portaminas EASY Ergo 3,15 mm Expositor de 9

6x diestros 3x zurdos

Código	Ref	U/Vta	U/Emb
10210167	7890/1-9-1HB	1	1

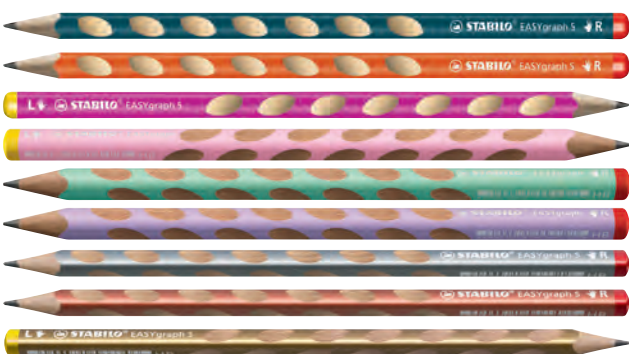

Lápiz de grafito Easy Graph S HB

Código	Ref	Artículo	Color	U/Vta	U/Emb
12801998	326/HB	Diestros	Petróleo	12	72
12801999	326/01-HB	Diestros	Rosa	12	72
12802000	326/02-HB	Diestros	Azul	12	72
12802002	326/03-HB	Diestros	Naranja	12	72
12802004	326/04-HB	Diestros	Verde	12	72
12802252	322/15-HB	Diestros	Verde pastel	12	72
12802253	322/16-HB	Diestros	Rosa pastel	12	72
12802254	322/17-HB	Diestros	Lila pastel	12	72
12802303	326/20-HB	Diestros	Oro	12	72
12802304	326/09-HB	Diestros	Plata	12	72
12802305	326/21-HB	Diestros	Cobre	12	72
12802005	325/HB-6	Zurdos	Petróleo	6	72
12802007	325/01-HB-6	Zurdos	Rosa	6	72
12802009	325/02-HB-6	Zurdos	Azul	6	72
12802255	321/15-HB-6	Zurdos	Verde pastel	6	6
12802256	321/16-HB-6	Zurdos	Rosa pastel	6	6
12802306	325/20-HB-6	Zurdos	Oro	6	6
12802307	325/09-HB-6	Zurdos	Plata	6	6
12802199	330/60-1HB	Exp. surtido de 60 pastel		1	1
12802010	327/90-HB	Exp. 90 (60 D+30 Z)		1	1



Recambio rotulador Easy Original 0,5 Pack de 3 azul

Código	Ref	U/Vta	U/Emb
25405014	6890/041	1	24



Minas Move EasyErgo estuche de 6

Código	Ref	U/Vta	U/Emb
21901149	7890/6-HB	1	15

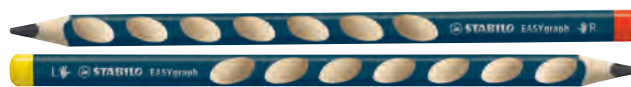

Lápiz grafito Easy Graph HB

Código	Ref	Artículo	Caja	U/Vta	U/Emb
15002061	321/HB-6	Zurdos	6 uds	1	6
15002060	322/HB	Diestros	12 uds	1	12



Lápices de colores Carbothello Estuche de metal

Código	Ref	Estuche	U/Vta	U/Emb
26501127	1412-6	12 uds	5	5
12801344	1424-6	24 uds	5	5



Novedad



Lápices acuarelables Aquacolor Estuche de metal

Código	Ref	Estuche	U/Vta	U/Emb
12801341	1612-5	12 uds	1	5
12801342	1624-5	24 uds	1	5
12801417	1636-5	36 uds	1	2

Novedad



Portaminas SuperGrip H-185 0.5 mm
Expositor de 60 uds

Código	Ref.	U/Vta	U/Emb
2430205	H-185-SL-60DPK	1	1



Marcador fluorescente V-LL

Código	Ref.	Color	U/Vta	U/Emb
10202314	SW-VLL-Y	Amarillo	12	144
10202311	SW-VLL-O	Naranja	12	144
10202313	SW-VLL-G	Verde	12	144
10202310	SW-VLL-L	Azul	12	144
10202309	SW-VLL-P	Rosa	12	144
10202312	SW-VLL-V	Violeta	12	144



Rotulador permanente Super Color Tinta

Código	Ref.	Color	Trazo	U/Vta	U/Emb
10209014	SC-W-EFE	Blanco	Fino	12	144
10209015	SC-W-M	Blanco	Grueso	12	144
10209012	SC-G-EFE	Oro	Fino	12	144
10209010	SC-G-M	Oro	Grueso	12	144
10209013	SC-S-EFE	Plata	Fino	12	144
10209011	SC-S-M	Plata	Grueso	12	144



Marcador permanente

- SCA-100 punta cónica de 1mm

Código	Ref.	Color	U/Vta	U/Emb
10201229	SCA-100-L	Azul	12	12
10201228	SCA-100-B	Negro	12	12
10201230	SCA-100-R	Rojo	12	12
10201231	SCA-100-G	Verde	12	12

- SCA-400 punta biselada de 4mm

Código	Ref.	Color	U/Vta	U/Emb
10201233	SCA-400-L	Azul	12	12
10201232	SCA-400-B	Negro	12	12
10201234	SCA-400-R	Rojo	12	12



Marcador y recambio de pizarra V Board Master
punta cónica, tinta líquida de color vivo

- Marcador

Código	Ref.	Tipo	U/Vta	U/Emb
10209118	WBMA-VBM-M-L-BG	Azul	10	400
10209117	WBMA-VBM-M-B-BG	Negro	10	400
10209119	WBMA-VBM-M-R-BG	Rojo	10	400
10209120	WBMA-VBM-M-G-BG	Verde	10	400
10209121	WBMA-VBM-M-O-BG	Naranja	10	400

- Recambio

Código	Ref.	Tipo	U/Vta	U/Emb
25403325	WBS-VBM-B	Negro	12	432
25403330	WBS-VBM-R	Rojo	12	432
25403329	WBS-VBM-L	Azul	12	432
25403332	WBS-VBM-G	Verde	12	432
25403342	WBS-VBM-O	Naranja	12	432



Rotulador y recambio de pizarra V Board Master
punta cónica tamaño S, tinta líquida de color vivo

- Marcador

Código	Ref.	Tipo	U/Vta	U/Emb
10203658	NVBSA	Azul	10	400
10203657	NVBSN	Negro	10	400
10203659	NVBSR	Rojo	10	400

- Recambio

Código	Ref.	Tipo	U/Vta	U/Emb
25401576	NRVBSA	Azul	12	432
25401575	NRVBSN	Negro	12	432
25401577	NRVBSR	Rojo	12	432



Pluma Pack Parallel Pen caligrafía

Código	Ref	Artículo	U/Vta	U/Emb
10501202	FP3-15-SS	1,5 mm	1	1
10501203	FP3-24-SS	2,4 mm	1	1
10501103	FP3-30-SS	3,0 mm	1	1
10501204	FP3-38-SS	3,8 mm	1	1
10501104	FP3-45-SS	4,5 mm	1	1
10501205	FP3-60-SS	6,0 mm	1	1



Bolígrafo retráctil Ecoball 1,0

Código	Ref.	Color	U/Vta	U/Emb
10101375	BP-B2PEB-M-L-BG	Azul	10	144
10101374	BP-B2PEB-M-B-BG	Negro	10	144
10101376	BP-B2PEB-M-R-BG	Rojo	10	144
10101377	BP-B2PEB-M-G-BG	Verde	10	144



Recambio para pluma Parallel Pen
Caja de 6

Código	Ref	Color	U/Vta	U/Emb
25401459	IC-P3-S6-B	Negro	1	12
25401654	IC-P3-S6-SP	Sepia	1	12



Recambio para pluma Parallel Pen
Caja de 12 colores surtidos

Código	Ref	U/Vta	U/Emb
25402044	IC-P3-AST	1	12



Roller gel retráctil B2P 0,7

Código	Ref.	Color	U/Vta	U/Emb
10102908	BL-B2P-7-L-BG	Azul	10	10
10102909	BL-B2P-7-B-BG	Negro	10	10
10102910	BL-B2P-7-R-BG	Rojo	10	10
11201186	BL-B2P-7-G-BG	Verde	10	10

Bolígrafo retráctil Supergrip G

Código	Ref.	Color	U/Vta	U/Emb
10101126	BPGG-8R-M-L	Azul	12	144
10101127	BPGG-8R-M-L	Negro	12	144
10101128	BPGG-8R-M-R	Rojo	12	144
10101129	BPGG-8R-M-G	Verde	12	144



Bolígrafo BPS-GP

Código	Ref.	Color	U/Vta	U/Emb
10102120	BPS-GP-M-L	Azul	12	144
10102121	BPS-GP-M-B	Negro	12	144
10102122	BPS-GP-M-R	Rojo	12	144
10102073	BPS-GP-M-G	Verde	12	144

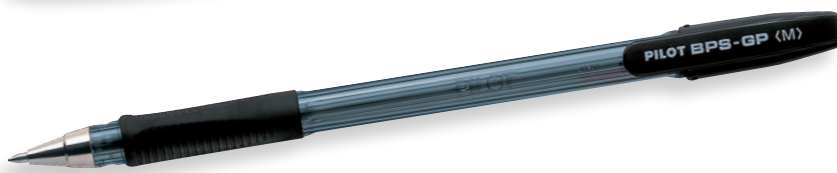

Bolígrafo RT Supergrip Tinta base de aceite

Código	Ref.	Color	U/Vta	U/Emb
10102150	BPGP-10R-M-L	Azul	12	144
10102151	BPGP-10R-M-B	Negro	12	144
10102152	BPGP-10R-M-R	Rojo	12	144
10102153	BPGP-10R-M-G	Verde	12	144
10102109	BPGP-10R-M-60DPK	Exp. 60 uds	1	1



Bolígrafo 4 colores Supergrip G

Código	Ref.	Color cuerpo	U/Vta	U/Emb
10101320	BPKGG-35M-B	Negro	12	144
10101321	BPKGG-35M-LB	Azul claro	12	144
10101322	BPKGG-35M-LG	Verde lima	12	144
10101323	BPKGG-35M-P	Rosa	12	144
10101324	BPKGG-35M-NC	Transparente	12	144



Roller Gel G2 Retráctil 0,7 mm

Código	Ref.	Color	U/Vta	U/Emb
10102165	BL-G2-7-L	Azul	12	144
10102178	BL-G2-7-B	Negro	12	144
10102236	BL-G2-7-R	Rojo	12	144
10102238	BL-G2-7-G	Verde	12	144
11201137	BL-G2-7-P	Rosa	12	144
11201138	BL-G2-7-V	Violeta	12	144
11201136	BL-G2-7-LB	Azul claro	12	144
10102183	BL-G2-7-60-DPK	Exp. 60 uds	1	1

Fabricado con un 70% de plástico reciclado. (Excepto partes recambiables)

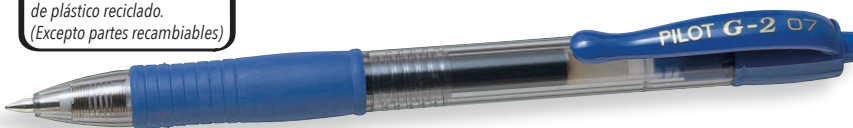

BORRABLES

Bolígrafo Friction Point Borrable - Punta de Synergy 0,5

Código	Ref.	Color	U/Vta	U/Emb
10102986	BL-FRP5-L	Azul	12	144
10102987	BL-FRP5-B	Negro	12	144
10102988	BL-FRP5-R	Rojo	12	144
10102956	BL-FRP5-60DPK-E	Exp. 60 uds	1	1



Bolígrafo borrable Friction ball 0,7 mm

Código	Ref.	Color	U/Vta	U/Emb
10102650	BL-FR7-L	Azul	12	144
10102651	BL-FR7-B	Negro	12	144
10102652	BL-FR7-R	Rojo	12	144
10102685	BL-FR7-G	Verde	12	144

Fabricado con un 50% de plástico reciclado. (Excepto partes recambiables)



PLASTIC FREE

Bolígrafo Friction Clicker 0,7

Código	Ref.	Color	U/Vta	U/Emb
10103124	BLRT-FR7-L	Azul	12	144
10103123	BLRT-FR7-B	Negro	12	144
10103125	BLRT-FR7-R	Rojo	12	144



Fabricado con un 50% de plástico reciclado. (Excepto partes recambiables)

Recambio para bolígrafo Friction Ball y Clicker Blíster de 3

Código	Ref.	Color	U/Vta	U/Emb
25402019	BLS-FR7-L-S3	Azul	12	144
25402020	BLS-FR7-B-S3	Negro	12	144
25402021	BLS-FR7-R-S3	Rojo	12	144
25401509	BLS-FR7-G-S3	Verde	12	144



Goma de borrar Friction Eraser

Código	Ref.	U/Vta	U/Emb
11101339	NGF	12	144

Marcador Friction fluorescente borrable amarillo Punta de fibra

Código	Ref.	U/Vta	U/Emb
10202729	SW-FL-Y	12	144



Roller tinta líquida V5

Código	Ref.	Color	U/Vta	U/Emb
10209017	BX-V5-L	Azul	12	144
10209019	BX-V5-B	Negro	12	144
10209020	BX-V5-R	Rojo	12	144
10209022	BX-V5-G	Verde	12	144
10209018	BX-V5-LB	Azul Claro	12	144
10209021	BX-V5-P	Rosa	12	144
10209016	BX-V5-V	Violeta	12	144



Roller tinta líquida V5 Grip

Código	Ref.	Color	U/Vta	U/Emb
10209091	BXGPN-V5-L	Azul	12	144
10209092	BXGPN-V5-B	Negro	12	144
10209093	BXGPN-V5-R	Rojo	12	144
10209094	BXGPN-V5-G	Verde	12	144



Roller tinta líquida V7

Código	Ref.	Color	U/Vta	U/Emb
10209023	BX-V7-L	Azul	12	144
10209024	BX-V7-B	Negro	12	144
10209035	BX-V7-R	Rojo	12	144
10209062	BX-V7-G	Verde	12	144



Roller tinta líquida V-Ball 07

Código	Ref.	Color	U/Vta	U/Emb
10209040	BL-VB7-L	Azul	12	144
10209041	BL-VB7-B	Negro	12	144
10209042	BL-VB7-R	Rojo	12	144
10209043	BL-VB7-G	Verde	12	144



Roller tinta líquida V-Ball 05

Código	Ref.	Color	U/Vta	U/Emb
10209032	BL-VB5-L	Azul	12	144
10209033	BL-VB5-B	Negro	12	144
10209034	BL-VB5-R	Rojo	12	144
10209004	BL-VB5-G	Verde	12	144



Roller tinta líquida VBall Grip 0,5 mm

Código	Ref.	Color	U/Vta	U/Emb
10102285	BLN-VBG5-L	Azul	12	144
10102286	BLN-VBG5-B	Negro	12	144
10102287	BLN-VBG5-R	Rojo	12	144
10102288	BLN-VBG5-G	Verde	12	144



Roller Gel G1

Código	Ref.	mm	Color	U/Vta	U/Emb
10102110	BL-G1-5T-L	0,5 mm	Azul	12	144
10102111	BL-G1-5T-B	0,5 mm	Negro	12	144
10102112	BL-G1-5T-R	0,5 mm	Rojo	12	144
10102542	BL-G1-7T-GD	0,7 mm	Oro	12	144
10102541	BL-G1-7T-SI	0,7 mm	Plata	12	144



Roller gel G-TEC-C4

Código	Ref.	Color	U/Vta	U/Emb
10209025	BL-GC4-L	Azul	12	144
10209026	BL-GC4-B	Negro	12	144
10209085	BL-GC4-R	Rojo	12	144
10209097	BL-GC4-G	Verde	12	144
10209007	BL-GC4-10C-60DPK	Expositor 60 uds. surtido	1	1



Bolígrafo G2 XS Pixie 0,7

Código	Ref.	Color	U/Vta	U/Emb
10102640	BL-G2-XS-7-L	Azul	12	144
10102641	BL-G2-XS-7-B	Negro	12	144
10102642	BL-G2-XS-7-R	Rojo	12	144
10102643	BL-G2-XS-7-G	Verde	12	144
10102620	BL-G2-XS-7-84DPK	Expositor 84 uds. surtido	1	1



Rotulador Sign Pen - Punta de Feltro 0,6

Código	Ref.	Color	U/Vta	U/Emb
10209063	SW-VSP-L	Azul	12	144
10209064	SW-VSP-B	Negro	12	144
10209065	SW-VSP-R	Rojo	12	144





Roller Tinta Líquida Eye Fine UB-157

Código	Ref.	Color	U/Vta	U/Emb
10211001	524405000	Azul	12	864
10211015	552208000	Azul claro	12	864
10211017	552182000	Naranja	12	864
10211002	524397000	Negro	12	864
10211003	524413000	Rojo	12	864
10211004	552224000	Rosa	12	864
10211005	552174000	Verde	12	864
10211016	552190000	Verde claro	12	864
10211006	552232000	Vino	12	864
10211018	552216000	Violeta	12	864



Bolígrafo Jetstream Sport retráctil 1,0

Código	Ref.	Color	U/Vta	U/Emb
10102783	019828000	Azul	12	864
10102784	019810000	Negro	12	864
10102785	019802000	Rojo	12	864



Roller Tinta Líquida Eye Micro UB-150

Código	Ref.	Color	U/Vta	U/Emb
10211007	534099000	Azul	12	864
10211008	534081000	Negro	12	864
10211009	534107000	Rojo	12	864
10211010	597377000	Verde	12	864



UB150: 6x 534081000 Negro 8x 534099000 Azul 4x 534107000 Rojo	UB157: 4x 552174000 Verde 3x 552208000 Azul claro 3x 552190000 Verde claro 2x 552216000 Naranja 3x 552224000 Rosa
---	---

Roller Tinta Líquida Eye UB-150/UB-157 Expositor de 36

Código	Ref.	U/Vta	U/Emb
11201190	182634735	1	12



Roller tinta líquida Eye Broad 1 (UB-150) Expositor de 36

Código	Ref.	U/Vta	U/Emb
11201161	182634685	1	24



Roller gel retráctil Jetstream Sport 1mm (SXN-150) Expositor de 36

Código	Ref.	U/Vta	U/Emb
10102708	182634734	1	12



Roller retráctil tinta híbrida Jetstream colores 0,7 Expositor 36 unidades

Código	Ref.	U/Vta	U/Emb
10101705	182634290	1	12



Roller gel retráctil Signo 207 0,7 (UMN-207) Expositor de 36 unidades

Código	Ref.	U/Vta	U/Emb
10101731	182634317	1	12



Roller gel retráctil Signo 307 0,7 (UMN-307) Expositor de 36 unidades.

Código	Ref.	U/Vta	U/Emb
11201018	182634486	1	1



Roller tinta líquida Air 0,7 Expositor de 36

Código	Ref.	U/Vta	U/Emb
11201004	182634473	1	1



Roller gel retráctil borrable 0,7 (UF-222)
Expositor de 36

Código	Ref.	U/Vta	U/Emb
10101380	182634756	1	12



Roller gel retráctil borrable 0,7 (UF-222)

Código	Ref.	Color	U/Vta	U/Emb
10101004	233767000	Azul	12	864
10101003	233759000	Negro	12	864
10101005	233775000	Rojo	12	864
10101025	233783000	Verde	12	864
10101027	233817000	Violeta	12	864
10101028	233809000	Rosa	12	864



***3 pin + 1 roller GRATIS!**
Exclusivo
Distrisantiago

Rotulador calibrado Pin Manga

*Promoción válida hasta fin de existencias

Código	Ref.	Artículo	U/Vta	U/Emb
10201577	182634325	Expositor 12	1	12
10206033	182634338	Bolsa de 3*	1	50



Roller gel retráctil 3 colores Jetstream 3 1,0 (SXE-400)
Expositor de 15

Código	Ref.	U/Vta	U/Emb
10101290	182634690	1	1



Roller gel Signo
Expositor de 48 (8 colores)

Código	Ref.	Artículo	U/Vta	U/Emb
10102626	789073000	Purpurina 1,0mm	1	1
10102627	787226000	Básicos 0,7mm	1	12



Portaminas Shalaku S 0,5 mm
Expositor de 48

Código	Ref.	U/Vta	U/Emb
24302344	096040000	1	12



Marcador especial para ropa Super Ink Marker
Expositor de 36 unidades

Código	Ref.	U/Vta	U/Emb
10204618	182634268	1	60



Marcador tiza líquida Chalk
Expositor surtido de 36

Código	Ref.	U/Vta	U/Emb
10205464	182634541	1	1





Regla de aluminio antideslizante Art Creation

Código	Ref.	Artículo	U/Vta	U/Emb
25501102	9682015M	15cm	1	12
25501103	9682020M	20cm	1	12
25501080	9682030M	30cm	1	12
25501081	9682040M	40cm	1	12
25501082	9682050M	50cm	1	12
25501083	9682060M	60cm	1	12
25501084	9682080M	80cm	1	12
25501085	9682000M	100cm	1	12



Tinta china negra, frasco de 30ml

Código	Ref.	U/Vta	U/Emb
10601252	44257002	1	3



Carboncillo Art Creation Caja de 3 uds (Medidas: F, M G)

Código	Ref.	U/Vta	U/Emb
15601012	9600034M	1	5



Rotulador acuarelable de fibra brushpen Ecoline Especial Lettering. Colores surtidos.

(colores primarios)

Código	Ref.	Estuche	U/Vta	U/Emb
10203074	11509007	10 uds	1	3
10203075	11509900	5 uds*	1	5



Rotulador calibrado Sakura Pigma Micron

Código	Ref.	Artículo	U/Vta	U/Emb
10203079	POXSDK3	Caja de 3 (0,2+0,4+0,8)	1	6
10203080	POXSDK6	Caja de 6 (0,05+0,1+0,2+0,3+0,5+0,8)	1	6
10203077	CDXSDK36	Expositor de 36	1	1



Lápices de colores Bruynzeel Estuche de metal de 45

Código	Ref.	U/Vta	U/Emb
12802134	60312903	1	4



Rotulador de fibra Bruynzeel Estuche de surtido de 50

Código	Ref.	U/Vta	U/Emb
10203076	60121150	1	6



Rotulador de fibra doble punta Art Creations

Código	Ref.	Estuche	U/Vta	U/Emb
10203575	60325012	12 uds	1	6
10203576	60325024	24 uds	1	6



Rotuladores de punta pincel
Rotuladores calibrados
Bloc de tapa dura
Pincel de agua

Set Lettering Sakura Azul iniciación

Código	Ref.	U/Vta	U/Emb
10204902	PO200031	1	1



Rotuladores de punta pincel
Rotuladores calibrados
Bloc de tapa dura
Cintas washi tapes

Set Bullet Journal Sakura iniciación

Código	Ref.	Descripción	U/Vta	U/Emb
10204904	PO20005	Naranja	1	1
10204903	PO20003	Menta	1	1



Bloc de dibujo Art Creation "Esbozo" espiral 100 hojas de 90g

Código	Ref.	Artículo	U/Vta	U/Emb
10001870	9318001M	A3	1	3
10001871	9318002M	A4	1	3



Lienzo algodón reforzado Art Creation

Código	Ref.	Artículo	U/Vta	U/Emb
29901044	9561244M	4F 24x33cm	1	5
29901045	9561273M	5F 27x35cm	1	5
29901046	9561334M	6F 33x41cm	1	5
29901047	9561384M	8F 38x46cm	1	5
29901048	9561465M	10F 46x55cm	1	5



Rodillo Soft 9,5cm para tinta y pintura sobre linóleo

Código	Ref.	U/Vta	U/Emb
12301413	9682163M	1	3



Caballote trípode Isabelle Art Creation madera de pino

Código	Ref.	Descripción	U/Vta	U/Emb
29901042	9105055M	170cm	1	1
29901081	91050296	150cm	1	1





15 acuarelas
Bloc y lápiz
Rotuladores calibrados
Pinceles y Paleta de plástico



Set acuarelas Van Gogh iniciación

Código	Ref.	U/Vta	U/Emb
13501214	P0200060	1	1



Acuarelas Art Creation Pocket Estuche de 12

Código	Ref.	U/Vta	U/Emb
13501181	9022112M	1	1



Acuarelas Van Gogh pocket Estuche de 5 (colores primarios)

Código	Ref.	U/Vta	U/Emb
13501213	20808605	10	10



Pintura acrílica Van Gogh 40ml Set de 5 tubos (colores primarios)

Código	Ref.	U/Vta	U/Emb
23501888	22820515	1	1

Sets de iniciación Tubo de 12ml

• Témpera

Código	Ref.	Estuche	U/Vta	U/Emb
27401636	9021608M	8 uds	1	1
27401637	9021612M	12 uds	1	1
27401638	9021624M	24 uds	1	1



• Acuarelas

Código	Ref.	Estuche	U/Vta	U/Emb
13501118	9022008M	8 uds	1	1
13501119	9022012M	12 uds	1	1
13501120	9022024M	24 uds	1	1



• Pintura óleo

Código	Ref.	Estuche	U/Vta	U/Emb
23501545	9020108M	8 uds	1	1
23501546	9020112M	12 uds	1	1
23501547	9020124M	24 uds	1	1



• Pintura acrílica

Código	Ref.	Estuche	U/Vta	U/Emb
23501548	9021708M	8 uds	1	1
23501549	9021712M	12 uds	1	1
23501550	9021724M	24 uds	1	1



Pintura acrílica Art Creation tubo de 75ml

*(blanco, amarillo, rojo, azul y negro)

Código	Ref.	Color	U/Vta	U/Emb
23501528	3511105M	Blanco puro	3	3
23501529	3511227M	Ocre amarillo	3	3
23501530	3511270M	Amarillo oscuro	3	3
23501531	3511275M	Amarillo primario	3	3
23501532	3511369M	Magenta primario	3	3
23501533	3511396M	Rojo medio	3	3
23501534	3511409M	Sombra tostada	3	3
23501535	3511411M	Siena tostada	3	3
23501536	3511504M	Azul ultramar	3	3
23501537	3511567M	Violeta rojizo	3	3
23501538	3511572M	Azul cian	3	3
23501539	3511619M	Verde oscuro	3	3
23501540	3511661M	Verde turquesa	3	3
23501541	3511701M	Negro marfil	3	3
23501542	3511800M	Plata	3	3
23501543	3511801M	Oro	3	3
23501544	3582805M	Set de 5 uds*	1	10

Pinceles Art Creation Bolsa de 3

• Acuarela y Témpera

Código	Ref.	Modelo	Contenido	U/Vta	U/Emb
12301208	9099161M	S	Toray bicolor redondo nº 8 + Plano nº 4 + Lengua de gato nº 4	1	6
12301209	9099162M	M	Toray bicolor redondo nº 10 + Plano nº 8 + Lengua de gato nº 8	1	6
12301210	9099163M	L	Toray bicolor redondo nº 14 + Plano nº 12 + Lengua de gato nº 12	1	6
12301211	9099164M	XL	Toray bicolor redondo nº 16 + Plano nº 16 + Lengua de gato nº 16	1	6

• Acrílico y Oleo

Código	Ref.	Modelo	Contenido	U/Vta	U/Emb
12301228	9099261M	S	Toray bicolor redondo nº 8 + Plano nº 4 + Lengua de gato nº 4	1	6
12301212	9099262M	M	Toray bicolor redondo nº 10 + Plano nº 8 + Lengua de gato nº 6	1	6
12301213	9099263M	L	Toray bicolor redondo nº 14 + Plano nº 12 + Lengua de gato nº 12	1	6
12301214	9099264M	XL	Toray bicolor redondo nº 16 + Plano nº 16 + Lengua de gato nº 16	1	6



Cuaderno para boceto con goma 80h 140g 130x210mm

Código	Ref.	Color	U/Vta	U/Emb
12601381	9314112M	Amarillo	5	5
12601383	9314212M	Azul	5	5
12601384	9314312M	Coral	5	5
12601380	9314052M	Corcho	5	5
12601385	9314432M	Kraft	5	5
12601382	9314142M	Oro	5	5
12601379	9314042M	Plata	5	5



Rotulador de colores Baby

Código	Ref.	Estuche	U/Vta	U/Emb
10202999	42815	6 uds	1	24
10202555	42816	12 uds	1	24



Ceras de colores Baby
Caja de 8

Código	Ref.	U/Vta	U/Emb
16001100	42892	6	48



N
Nuevo estuche



Emociones diferentes

Ceras de colores Baby Teddy

Código	Ref.	Estuche	U/Vta	U/Emb
16001195	42956	6 uds	1	12
16001524	43957	12 uds	1	24



Lápices de colores Baby

Código	Ref.	Estuche	U/Vta	U/Emb
16001511	42817	6 uds	1	24
16001101	42818	10 uds	1	24



Lápices de colores Baby
Caja de 10

Código	Ref.	U/Vta	U/Emb
12802291	42819	1	96



Rotulador Baby marker
Estuche de 6

Código	Ref.	U/Vta	U/Emb
10202998	42813	1	24



Pintura de dedos Baby

Código	Ref.	Artículo	U/Vta	U/Emb
23501747	43174	Caja de 8	1	12
23501748	K0032	Caja de 6	1	24



Plastilina Baby Dough vasitos 75gr

Código	Ref.	Artículo	U/Vta	U/Emb
24101445	43179	Caja de 3	1	12
24101446	43180	Caja de 8	1	6



Ceras plastificadora Jumbo triangular Neón
Blister de 12

Código	Ref.	U/Vta	U/Emb
16001525	44164	1	24



Pintura de dedos 50ml
Estuche de 4

Código	Ref.	U/Vta	U/Emb
23501746	43173	1	24





Rotulador Joy Punta fina

Código	Ref.	Estuche	U/Vta	U/Emb
10201018	40614	12 uds	12	48
10201019	40555	18 uds	1	24
10201020	40615	24 uds	6	24



Rotulador Birello Doble punta, fina y gruesa

Código	Ref.	Estuche	U/Vta	U/Emb
10201495	41457	12 uds	12	48
10201588	41521	24 uds	1	24



Rotulador Jumbo Punta Gruesa

Código	Ref.	Artículo	U/Vta	U/Emb
10201023	40569	Estuche 12 uds	12	48
10201497	40570	Estuche 24 uds	6	24
10203814	42312	Bote 50 uds	1	12



Lápices de colores Supercolor

Código	Ref.	Estuche	U/Vta	U/Emb
12802517	43391	12 uds	1	12
12802518	43392	18 uds	1	6
12802519	43393	24 uds	1	6
12802520	43394	36 uds	1	4



Lápices de colores Supercolor triangular

Código	Ref.	Estuche	U/Vta	U/Emb
12802521	43440	12 uds	1	12
12802522	43441	24 uds	1	6



Lápices de colores Supercolor Maxi triangular

Código	Ref.	Estuche	U/Vta	U/Emb
12802523	43450	6 uds	1	6
12802524	43451	12 uds	1	12



Lápices de colores Tita hexagonal

Código	Ref.	Estuche	U/Vta	U/Emb
12801476	42793	12 Uds	12	72
12801477	42794	24 Uds	6	36



Lápices de colores Tita triangular

Código	Ref.	Estuche	U/Vta	U/Emb
12801478	42786	12 Uds	12	72
12801479	42787	24 Uds	6	72



Lápices de colores Tita MAXI triangular Estuche de 12

Código	Ref.	U/Vta	U/Emb
12801480	42791	6	24



Lápices de colores Tita Tube + sacapuntas

Código	Ref.	Estuche	U/Vta	U/Emb
12802293	43340	12 uds	1	12
12802294	43341	24 uds	1	6
12802295	43342	36 uds	1	6



Marcador textil Fabric Estuche de 12

Código	Ref.	U/Vta	U/Emb
10201127	40957	1	48



Ceras plastcera Jumbo triangular Blíster de 10+2

Código	Ref.	U/Vta	U/Emb
16001086	42671	1	24

7x 40569 Jumbo 1 pieza
 9x 40614 Joy 12 piezas
 9x 41457 Birello box 12 piezas
 9x 42785 Neon Wallet 8 piezas
 12x 42793 Tita pencil 12 piezas
 8x 42400 watercolor 12 piezas



Lote School

Código	Ref.	U/Vta	U/Emb
18901357	50037	1	1



Rotulador fibra Magic Stereo Markers Color Change

Código	Ref.	Estuche	U/Vta	U/Emb
10201126	41369	20 uds	1	12
10203815	43183	30 uds	1	10



Rotulador Metallic

Código	Ref.	Estuche	U/Vta	U/Emb
10203818	43162	Fine - Caja 8 uds	1	24
10203819	43161	Maxi - Caja 6 uds	1	24

Ceras de colores triangulares Metallic Maxi Caja de 8

Código	Ref.	U/Vta	U/Emb
16001510	43163	1	72

Lápices de colores Metallic Caja de 12

Código	Ref.	U/Vta	U/Emb
12802292	43164	1	72



Rotulador fibra perfumado Maxi Caja de 10

Código	Ref.	U/Vta	U/Emb
10202898	42989	1	24

Rotulador fibra perfumado Stamps Caja de 8

Código	Ref.	U/Vta	U/Emb
10202899	42988	1	24

Rotulador fibra perfume Caja de 12

Código	Ref.	U/Vta	U/Emb
10201124	42672	1	24

Rotulador fibra Perfume Caja de 30

Código	Ref.	U/Vta	U/Emb
10203408	43082	1	12



Rotulador fibra lavable Neón Caja de 8

Código	Ref.	U/Vta	U/Emb
10201128	42785	1	24



Rotulador Super Brush (caligrafía) Caja de 10

Código	Ref.	Estuche	U/Vta	U/Emb
10202299	42937	10 uds	1	24
10202900	42968	20 uds	1	24



Rotulador fibra lavable Acquarell Caja de 12

Código	Ref.	U/Vta	U/Emb
10201123	42747	1	24



Marcador pastel
Expositor de 16 uds

Código	Ref.	U/Vta	U/Emb
10202902	43035	1	6



Rotulador pastel
Blister de 8

Código	Ref.	U/Vta	U/Emb
10202901	43032	1	24



Rotulador Jumbo punta gruesa
En botes unicolor

Código	Ref.	Color	U/Vta	U/Emb
10201420	43380/18	Azul	30	1200
10201535	43380/01	Negro	30	1200
26501192	43380/03	Rojo	30	1200



Recambio OOps borrable
Blister de 3

Código	Ref.	Color	U/Vta	U/Emb
25401528	43041/02	Azul	24	120
25401527	43041/01	Negro	24	120
25401529	43041/03	Rojo	24	120



Bolígrafo OOps Pop borrable
Caja de 12

Código	Ref.	Color	U/Vta	U/Emb
10101430	42044/02	Azul	1	24
10101429	42044/01	Negro	1	24
10101431	42044/03	Rojo	1	24



Bolígrafo borrable OOps
Expositor sobremesa 24 uds

Código	Ref.	Descripción	U/Vta	U/Emb
10101233	43040	Capuchón	1	8
10101234	43044	Clip	1	8



Con un pequeño imán para que el estuche se mantenga abierto cuando está en posición vertical

Estuche Gnam (vacío)

Código	Ref.	U/Vta	U/Emb
11301246	23280	6	24



Plastilina barra 20gr
Caja de 10

Código	Ref.	U/Vta	U/Emb
24101425	42173	6	24



Plastilina pastel barra 20gr
Caja de 6

Código	Ref.	U/Vta	U/Emb
24101426	42174	6	24



Acuarelas 30mm + pincel
Estuche de 12

Código	Ref.	U/Vta	U/Emb
13501113	42400	12	72



Témpera líquida acrílic

• Botella 250ml

Código	Ref.	Color	U/Vta	U/Emb
27401791	40431/03	Amarillo	1	6
27401792	40431/10	Rojo	1	6
27401793	40431/19	Oro	1	6
27401794	40431/05	Azul	1	6

• Botella 500ml

Código	Ref.	Color	U/Vta	U/Emb
27401787	40432/03	Amarillo	1	6
27401788	40432/05	Azul	1	6
27401789	40432/01	Blanco	1	6
27401790	40432/02	Negro	1	6



Témpera líquida acrílic Estuche de 12 (10ml)

Código	Ref.	U/Vta	U/Emb
27401795	40012	1	12



Témpera líquida acrílic Estuche de 12 (12ml)

Código	Ref.	U/Vta	U/Emb
27401796	40014	1	12



Témpera sólida Temperello Pcket Estuche de 6 (10gr)

Código	Ref.	Artículo	U/Vta	U/Emb
27401628	42675	Neón	1	96
27401629	42674	Metallic	1	96



Témpera sólida Temperello pocket Estuche de 12 (10gr)

Código	Ref.	U/Vta	U/Emb
27401495	42738	1	48



Maquillaje en barra de 5,9g Caja de 3

Código	Ref.	Artículo	U/Vta	U/Emb
30001224	43050	Carnaval	1	48
30001225	43051	Monster	1	48
30001222	43048	Animales	1	48
30001223	43049	Princesas	1	48



Maquillaje en barra Set de 6

Código	Ref.	Artículo	U/Vta	U/Emb
30001252	43156	Fluor*	1	48
30001259	43155	Metallic	1	48

*BRILLA EN LA OSCURIDAD



Marcador pizarra Maxiflo MWL5S punta cónica de 4mm (trazo de 2mm)

Código	Ref.	Color	U/Vta	U/Emb
10201210	MWL5S-C	Azul	12	288
10201209	MWL5S-A	Negro	12	288
10201211	MWL5S-B	Rojo	12	288
10201212	MWL5S-D	Verde	12	288

Marcador para pizarra blanca tinta líquida con punta cónica muy resistente. No se seca, intensidad de color hasta la última gota.



Marcador permanente Maxiflo NLF50 punta cónica de 4,5mm (trazo de 2mm)

Código	Ref.	Color	U/Vta	U/Emb
10201003	NLF50-A	Negro	12	288
10201001	NLF50-C	Azul	12	288
10201007	NLF50-B	Rojo	12	288

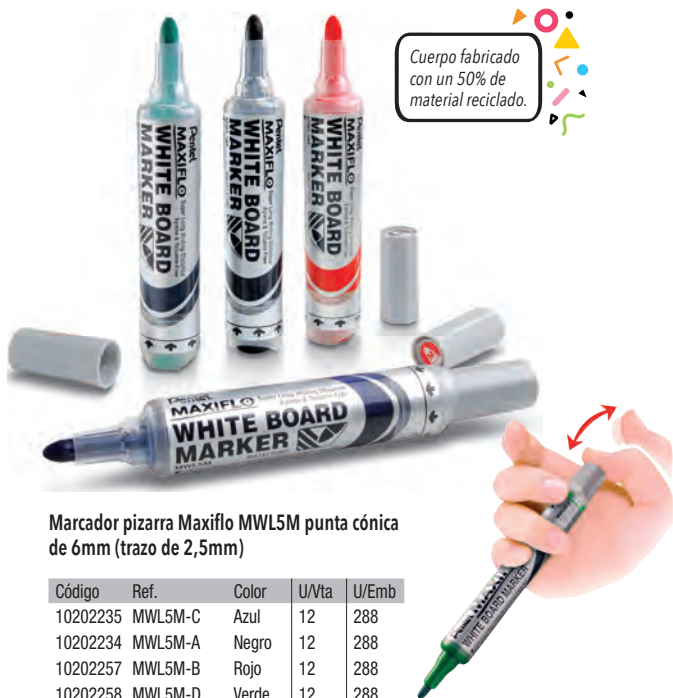

Cuerpo fabricado con un 50% de material reciclado.

Marcador pizarra Maxiflo MWL5M punta cónica de 6mm (trazo de 2,5mm)

Código	Ref.	Color	U/Vta	U/Emb
10202235	MWL5M-C	Azul	12	288
10202234	MWL5M-A	Negro	12	288
10202257	MWL5M-B	Rojo	12	288
10202258	MWL5M-D	Verde	12	288



Incluye borrador imantado

Marcador pizarra Maxiflo MWL5S punta cónica 2mm Surtido set de 4

Código	Ref.	U/Vta	U/Emb
10201216	MWL5S-4N	1	72



Roller gel retráctil Energel BL-107 0,7mm. Recargable

Código	Ref.	Color	U/Vta	U/Emb
11201134	BL107-C	Azul	12	288
11201132	BL107-A	Negro	12	288
11201133	BL107-B	Rojo	12	288
11201150	BL107-D	Verde	12	288
11201191	BL107/12COL-72	Expositor de 72	1	1

Fabricado en un 87% con plástico reciclado.



Roller gel retráctil BL-77 Energel 0,7

Código	Ref.	Color	U/Vta	U/Emb
11201059	BL77-A	Negro	12	576
11201060	BL77-C	Azul	12	576
11201061	BL77-B	Rojo	12	576
11201102	BL77 CA	Azul marino	12	576
11201103	BL77 ST	Azul turquesa	12	576
11201104	BL77 AC	Azul claro	12	576
11201105	BL77 D	Verde	12	576
11201106	BL77 P	Rosa	12	576
11201107	BL77 F	Naranja	12	576
11201108	BL77 V	Violeta	12	576
11201109	BL77 K	Verde flúor	12	576
11201110	BL77 E	Marrón	12	576

Fabricado en un 87% con plástico reciclado.



Bolígrafo BK-77 de 0,7mm (trazo de 0,25mm)

Código	Ref.	Color	U/Vta	U/Emb
10102064	BK77-A	Negro	12	576
10102065	BK77-C	Azul	12	576
10102065	BK77-B	Rojo	12	576
10102066	BK77-D	Verde	12	576



Portaminas Fiesta

Código	Ref.	Artículo	U/Vta	U/Emb
12501059	AX105-C	0,5 mm	12	576
12501060	AX107-C	0,7 mm	12	576
12501160	AX125/36	Expositor de 36	1	1



Marcador textil Pepito Green Label negro

Código	Ref.	U/Vta	U/Emb
10202786	NM10 A	12	480



Roller gel retráctil Energel 0,7

Código	Ref.	Caja	U/Vta	U/Emb
11201281	BL77-6	6 uds	1	
11201280	BL77-12	12 uds	1	



Clic Eraser ZE32-YO

• Portagomas

Código	Ref.	U/Vta	U/Emb
11101266	ZE32-YO	12	288

• Recambio

Código	Ref.	U/Vta	U/Emb
11101338	ZER4-10	12	576



Minas HB (tubo de 12)

Código	Ref.	Artículo	U/Vta	U/Emb
21901048	C505.HB	0,5mm	12	1728
21901184	50-7-Pentel-HB	0,7mm	12	1728



Recambio roller gel energel LR7 (para el BL107 y el BL77)

Código	Ref.	Color	U/Vta	U/Emb
25401188	LR7-A	Negro	12	576
25401189	LR7-B	Rojo	12	576
25401313	LR7-C	Azul	12	576



Marcador flúor Illumina Flex doble punta

Código	Ref.	Color	U/Vta	U/Emb
10204760	SLW11P-GE	Amarillo	10	400
10204766	SLW11P-CE	Azul	10	400
10204764	SLW11P-SE	Azul claro	10	400
10204762	SLW11P-NE	Gris	10	400
10204664	SLW11P-FE	Naranja	10	400
10204763	SLW11P-PE	Rosa	10	400
10204761	SLW11P-KE	Verde	10	400
10204765	SLW11P-VE	Violeta	10	400



Rotulador de fibra Touch

Código	Ref.	Artículo	U/Vta	U/Emb
10203534	SES15-4	Estuche de 4 (col. básicos)	1	1
10203535	SES15-4/COL	Estuche de 4 (col. fuertes)	1	1
10203536	SES15/75	Expositor de 75	1	1



Corrector cinta Knoky Expositor de 60

Código	Ref.	U/Vta	U/Emb
15101132	XZTT805/60	1	1



Corrector liquido bolígrafo ZL63 7 ml punta metal

Código	Ref.	U/Vta	U/Emb
15101054	ZL63-W	12	288



Rotulador calibrado S20P Pointliner 0,5mm

Código	Ref.	Color	U/Vta	U/Emb
10204992	S20P-Pentel-5N	Gris	1	
10204993	S20P-Pentel-5SG	Sanguina	1	
10204994	S20P-Pentel-5SP	Sepia	1	



Rotulador calibrado S20P Pointliner

Código	Ref.	Artículo	U/Vta	U/Emb
10204983	S20P-Pentel-0,03	0,03 mm	1	
10204984	S20P-Pentel-0,05	0,05 mm	1	
10204985	S20P-Pentel-0,1	0,1 mm	1	
10204986	S20P-Pentel-0,2	0,2 mm	1	
10204987	S20P-Pentel-0,3	0,3 mm	1	
10204988	S20P-Pentel-0,4	0,4 mm	1	
10204989	S20P-Pentel-0,5	0,5 mm	1	
10204990	S20P-Pentel-0,8	0,8 mm	1	
10204991	S20P-Pentel-10A	1,0 mm	1	



Pincel de agua Aquash

Código	Ref.	Punta	U/Vta	U/Emb
12301144	XFRH-F	Fina	12	288
12301145	XFRH-M	Media	12	288
12301146	XFRH-B	Gruesa	12	288



Ceras oil pastel metálicos y fluorescentes Estuche de 12

Código	Ref.	U/Vta	U/Emb
16001532	PHN-MF12	1	



Ceras Textil pastel

Código	Ref.	Caja	U/Vta	U/Emb
16001115	PTS-7	7 uds	1	288
16001116	PTS-15	15 uds	1	144



Ceras Oil pastel

Código	Ref.	Caja	U/Vta	U/Emb
16001112	PHN-12	12 uds	1	144
16001113	PHN-25	25 uds	1	96
16001114	PHN-50	50 uds	1	48



Fabricados con madera suprarreciclada



Lápices de colores 185 Noris Colour

Código	Ref.	Uds	U/Vta	U/Emb
12802075	185 C12	12 Uds	1	5
12802165	185 C18	18 Uds	5	5
12802076	185 C24	24 Uds	1	5
12801920	185 CD36	36 Uds	1	5



Lápices de colores 185 Noris Colour Estuche metálico

Código	Ref.	Uds	U/Vta	U/Emb
12802181	185 M24	24 Uds	5	5
12802182	185 M36	36 Uds	3	3

Fabricados con madera suprarreciclada



Lápices de colores acuarelables 144 10 Noris Aquarell

Código	Ref.	Estuche	U/Vta	U/Emb
12801457	144 10NC12	12 Uds	1	10
12801458	144 10NC24	24 Uds	1	5



Fabricados con madera suprarreciclada

Lápices de colores triangulares Noris Colour 187

Código	Ref.	Estuche	U/Vta	U/Emb
12802090	187 C12	12 Uds	10	10
12802091	187 C24	24 Uds	5	5



Lápices de colores 188 Noris Colour Jumbo Estuche de 12

Código	Ref.	U/Vta	U/Emb
12802482	188 C12	1	1



Lápices de colores 146 Happy Line Estuche de 12

Código	Ref.	U/Vta	U/Emb
12802398	146 C12 HA	1	1

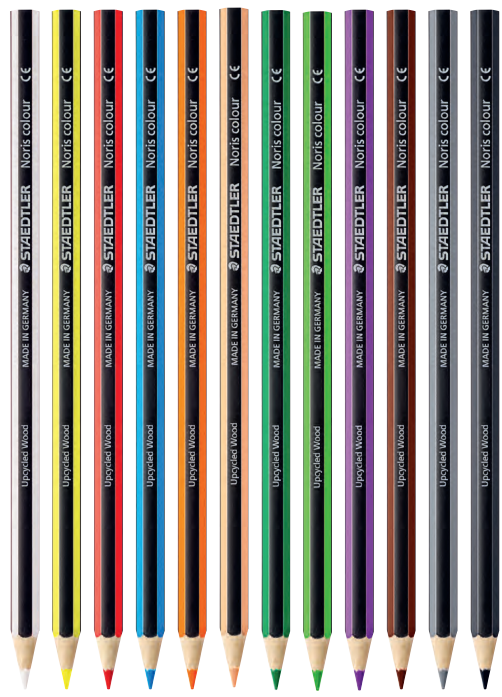

Fabricados con madera suprarreciclada

Lápices de Colores 185 Noris Colour Uniclor

Código	Ref.	Color	U/Vta	U/Emb
12801189	185-0	Blanco	12	72
12801230	185-10	Amarillo claro	12	72
12801234	185-2	Rojo claro	12	72
12801265	185-3	Azul	12	72
12801289	185-30	Azul Claro	12	72
12801352	185-4	Naranja	12	72
12801353	185-43	Carne	12	72
12801358	185-5	Verde	12	72
12801411	185-50	Verde Claro	12	72
12801459	185-6	Violeta	12	72
12801460	185-76	Marrón	12	72
12801461	185-80	Gris claro	12	72
12801462	185-9	Negro	12	72



Lápiz flúor 128 64 Textsurfer Dry

Código	Ref.	Color	U/Vta	U/Emb
12801147	128 64-1	Amarillo	12	72
12801149	128 64-23	Rosa	12	72
12801145	128 64-4	Naranja	12	72
12801146	128 64-5	Verde	12	72
12801238	128 64KP48	Expositor de 48	1	1

72x Lapices 118
48x Lapices 119
36x Portaminas 777
10x Lápices 146C
8x Gomas 526 B20
8x Afilalápices 512



**Gama Happy Line
Expositor 182**

Código	Ref.	U/Vta	U/Emb
12802397	61 SCA2 HA	1	1



Rotulador de fibra Jumbo Noris 340

Código	Ref.	Estuche	U/Vta	U/Emb
10204141	340 WP6	6 uds	1	20
10204159	340 WP12	12 uds	1	10
10204758	340 C144	144 uds	1	1



**Rotulador Fibra 320 Noris
Doble punta
Estuche 12 Uds**

Código	Ref.	U/Vta	U/Emb
10204539	320 NWP12	1	10



Rotulador de fibra Noris 326

Código	Ref.	Color	U/Vta	U/Emb
10201863	326-1	Amarillo	10	100
10204088	326-2	Rojo	10	100
10201864	326-20	Magenta	10	100
10204087	326-3	Azul	10	100
10201865	326-30	Azul Claro	10	100
10201866	326-4	Naranja	10	100
10204019	326-5	Verde	10	100
10201867	326-51	Verde Claro	10	100
10201868	326-6	Violeta	10	100
10201869	326-7	Marrón	10	100
10201870	326-76	Pardo Van Dick	10	100
10201871	326-8	Gris	10	100
10204086	326-9	Negro	10	100
10204605	326 C100	Pack de 100 surtidos	1	1



**Rotulador de fibra 326 doble punta/color
Caja de 10 (20 colores)**

Código	Ref.	U/Vta	U/Emb
10204261	3280 C10	1	10



**Rotulador Fibra Noris 326
Caja de Cartón 80% material reciclado**

Código	Ref.	Color	U/Vta	U/Emb
10204259	326 C10	10 colores	1	10
10204260	326 C20	20 colores	1	10



**Acuarelas Noris 888
12 pastillas 30mm + tubo blanco + pincel**

Código	Ref.	U/Vta	U/Emb
13501024	888 NC12	1	10



Bolígrafo retráctil 423 medio

Código	Ref.	Color	U/Vta	U/Emb
10101831	4230 M-3	Azul	10	10
10101832	4230 M-9	Negro	10	10
10101753	4230 M-2	Rojo	10	10
10101833	4230 MC8	Estuche de 8	1	1



Bolígrafo 432 medio

Código	Ref.	Color	U/Vta	U/Emb
10101502	4320 M-3	Azul	10	10
10101752	4320 M-9	Negro	10	10
10101501	4320 M-2	Rojo	10	10
10101834	4320 MC10	Estuche de 10	1	1
10101844	4320 MKP50	Estuche de 50	1	1



Lápiz de grafito

Nombre	Características	Código	Ref.	U/Vta	U/Emb
119 Noris Jumbo (triangular)		12801142	119	12	72
120 Noris	<p>Fabricados con madera suprarreciclada</p>	Nº 0 - 2B 12801010 Nº 1 - B 12801063 Nº 2 - HB 12801064 Nº 3 - H 12801066 Nº 4 - 2H 12801067	120-0 120-1 120-2 120-3 120-4	12	72
122 Noris con goma	Nº 2	12801027	122-HB	12	72
Mars Lumograph Black 100B	2B 4B 6B 8B	12801469 12801470 12801471 12801472	100B-2B 100B-4B 100B-6B 100B-8B	12	72
110 Tradition	6B 4B 3B 2H B HB H F 2B 3H 4H	12801022 12801096 12801097 12801098 12801099 12801100 12801101 12801102 12801103 12801104 12801105	110-6B 110-4B 110-3B 110-2H 110-B 110-HB 110-H 110-F 110-2B 110-3H 110-4H	12	72



Lápiz de grafito
141 Noris Junior - 2B

Código	Ref.	U/Vta	U/Emb
12802290	141-2B	6	18

Primer lápiz extra grueso para los más pequeños.



Escribe y dibuja sobre dispositivos móviles con tecnología pantalla EMR.

Lápiz Noris digital

Código	Ref.	Artículo	U/Vta	U/Emb
12802265	180 22-1	Slim	1	4
12802266	180J 22-1	Jumbo	1	4

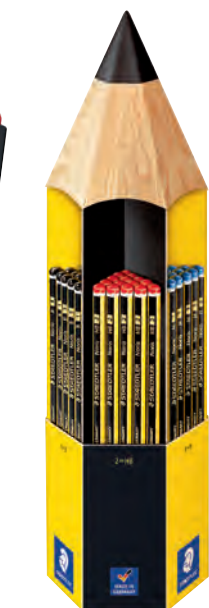

Lápiz de grafito 120 Noris
Expositor de 90 surtidos

Código	Ref.	U/Vta	U/Emb
12801804	120 CT90	1	1



Lápiz de grafito 120 Noris
Nº2 HB
Estuche hexagonal de 12

Código	Ref.	U/Vta	U/Emb
12802272	61 120P2	1	1



Incluye:
Goma mini Noris
Afilalápiz negro de plástico

Lápiz de grafito 120 Noris
Expositor giratorio de 576

Código	Ref.	U/Vta	U/Emb
12802017	120 VS4	1	1



Lápiz de grafito 119 Noris Triplus Jumbo
Expositor de 48

Código	Ref.	U/Vta	U/Emb
12801237	119 NKP48	1	1



Lápiz de grafito Noris Happy Line

• 118 SLIM - Expositor 72

Código	Ref.	U/Vta	U/Emb
12802395	118 KP72HA	1	1

• 119 JUMBO - Expositor 48

Código	Ref.	U/Vta	U/Emb
12802396	119 KP48HA	1	1



**Rotulador calibrado 308
Pigment Liner**

Código	Ref.	Trazo	U/Vta	U/Emb
10204037	308 005-9	0,05mm	10	100
10204080	308 01-9	0,1mm	10	100
10204002	308 02-9	0,2mm	10	100
10204081	308 03-9	0,3mm	10	100
10204003	308 04-9	0,4mm	10	100
10204082	308 05-9	0,5mm	10	100
10204066	308 06-9	0,6mm	10	100
10204083	308 07-9	0,7mm	10	100
10204004	308 08-9	0,8mm	10	100
10201152	308 10-9	1,0mm	10	100
10201153	308 12-9	1,2mm	10	100
10201154	308 C2-9	0,3-2mm*	10	100

*Punta biselada



**Rotulador calibrado 308
Bolsa de 3 (0,2 - 0,4 - 0,8mm)**

Código	Ref.	U/Vta	U/Emb
10204001	308 WP3 SP	1	10



**Rotulador calibrado
Expositor surtido**

Código	Ref.	Artículo	U/Vta	U/Emb
25701001	308 CA120	120 uds	1	1
10203417	308 CA60	70 uds	1	1



**Rotulador Fibra 334
Fineliner Triplus 0,3mm**

Código	Ref.	Uds	U/Vta	U/Emb
10204195	334 SB4	4	1	10
10204196	334 SB10	10	1	10
10204197	334 SB20	20	1	10



**Rotulador fibra 334
Fineliner Triplus 0,3mm
Estuche de 6**

Código	Ref.	Artículo	U/Vta	U/Emb
10211778	334 SB6CS3	Neón	2	10
10202277	334 SB6CS1	Pastel	2	10
10202275	334 SB6CS6	Flamingo	2	10



**Rotulador Fibra 323
Triplus Color 1mm**

Código	Ref.	Uds	U/Vta	U/Emb
10204483	323 SB10	10	1	10
10204484	323 SB20	20	1	10



**Rotulador fibra 323
Triplus color 1mm
Estuche de 6 colores pastel**

Código	Ref.	U/Vta	U/Emb
10202272	323 SB6CS01	2	10



**Rotulador fibra 334 Triplus Fineliner
Estuche de 25**

Código	Ref.	U/Vta	U/Emb
10204265	334 C25 TA	1	10



**Rotulador fibra 323 Triplus Color
Estuche de 25**

Código	Ref.	U/Vta	U/Emb
10204268	323 C25 TA	1	10



**Marcador Flúor 362 Triplus Textsurfer
Caja de 10**

Código	Ref.	U/Vta	U/Emb
10202948	362 CSB10	1	10



Marcador Flúor 364 Textsurfer Classic

Código	Ref.	Artículo	U/Vta	U/Emb
10202064	364-1	Amarillo	10	50
10202067	364-2	Rojo	10	50
10202065	364-3	Azul	10	50
10202066	364-4	Naranja	10	50
10202068	364-5	Verde	10	50
10202005	364-6	Violeta	10	50
10202269	364-23	Rosa	10	50
10202007	364-35	Turquesa	10	50
10203333	364 C-550	Verde intenso	10	5
10203332	364 C-200	Rojo intenso	10	5
10203956	364 C-20	Magenta	10	50
10203957	364 C-400	Naranja	10	50

Marcador Flúor 364 Textsurfer Classic Pastel&Vintage

Código	Ref.	Artículo	U/Vta	U/Emb
10202845	364 C-100	Amarillo claro	10	50
10202849	364 C-450	Arena	10	50
10202847	364 C-305	Azul cielo	10	50
10202846	364 C-210	Carmin claro	10	50
10202853	364 C-820	Gris claro	10	50
10202852	364 C-620	Lavanda	10	50
10202848	364 C-405	Melocotón	10	50
10202850	364 C-505	Menta	10	50
10202854	364 C-9	Negro	10	50
10202851	364 C-530	Verde lima	10	50



18x Marcadores flúor pastel
30x Triplus fineliner pastel
30x Triplus color pastel



Marcador Flúor Expositor surtido de 78

Código	Ref.	U/Vta	U/Emb
10203337	61 SCA1 PA	1	1

18x Marcadores flúor
30x Triplus fineliner
30x Triplus color



Marcador Flúor Happy Line Expositor de 78

Código	Ref.	U/Vta	U/Emb
10204264	61 SCA1 HA	1	1



Marcador Flúor 364 Textsurfer Classic surtido

Código	Ref.	Artículo	U/Vta	U/Emb
10201114	364-S WP4P	Blisters 4 (3+1)	1	10
10203334	364 CWP4-X	Blisters 4	5	10
10202389	364 WP6	Blisters de 6	5	5
10202452	364 A WP8	Blisters de 8 (6+2)	1	5
10201113	364 CA60	Expositor surtido de 60	1	1

Marcador Flúor 364 Textsurfer Classic Pastel & Vintage

Código	Ref.	Estuche	U/Vta	U/Emb
10202857	364 CWP10	10 uds	1	5
10202856	364 CWP6	6 uds	1	5
10202855	364 CWP4	4 uds	1	10
10203599	364 WP20	20 uds (10 neón + 10 pastel&vintage)	1	5
10202949	364 CCA60	Expositor surtido de 78	1	10



Marcador Flúor 364 Textsurfer Happy Line

Código	Ref.	Blisters	U/Vta	U/Emb
10204262	364 C6 HA	6 uds	1	10
10204263	364 C8 HA	8 uds	1	5



Marcador pizarra blanca 351 Lumocolor cónico

Código	Ref.	Estuche	U/Vta	U/Emb
10204566	351 WP4	4 uds (azul, negro, rojo y verde)	2	10
10203606	351 WP4-1	4 uds (rosa, azul verde y negro)	2	5
10201115	351 WP8	8 uds	1	10
10203605	351 B10	10 uds	1	10



Marcador Pizarra 351 Lumocolor cónico

Código	Ref.	Color	U/Vta	U/Emb
10204152	351-3	Azul	10	50
10204153	351-2	Rojo	10	50
10204154	351-9	Negro	10	50
10204156	351-5	Verde	10	50
10203602	351-20	Rosa	10	10
10203603	351-30	Azul claro	10	10
10201205	351-4	Naranja	10	10
10203604	351-53	Verde claro	10	10
10201206	351-6	Violeta	10	10
10201207	351-7	Marrón	10	10



Marcador permanente Lumocolor

• 352 - Cónica

Código	Ref.	Color	U/Vta	U/Emb
10204047	352-3	Azul	10	100
10204048	352-9	Negro	10	100
10204049	352-2	Rojo	10	100
10204050	352-5	Verde	10	100

• 350 - Biselado

Código	Ref.	Color	U/Vta	U/Emb
10204043	350-3	Azul	10	100
10204044	350-9	Negro	10	100
10204045	350-2	Rojo	10	100
10204046	350-5	Verde	10	100



Marcador Permanente Lumocolor 348 Permanente DUO cónico

Código	Ref.	Artículo	U/Vta	U/Emb
10204550	348-9	Negro	10	100
10204551	348-3	Azul	10	100
10204552	348-2	Rojo	10	100
10204553	348-5	Verde	10	100



Rotulador Permanente

• Lumocolor 313 S

Código	Ref.	Color	U/Vta	U/Emb
10204536	313-7	Marrón	10	100
10204005	313-3	Azul	10	100
10204006	313-9	Negro	10	100
10204007	313-2	Rojo	10	100
10204008	313-5	Verde	10	100
10204591	313-1	Amarillo	10	100
10204537	313-6	Violeta	10	100
10204592	313-4	Naranja	10	100

• Lumocolor 317 M

Código	Ref.	Color	U/Vta	U/Emb
10204009	317-3	Azul	10	100
10204010	317-9	Negro	10	100
10204011	317-2	Rojo	10	100
10204012	317-5	Verde	10	100
10204461	317-7	Marrón	10	100
10204524	317-4	Naranja	10	100
10204525	317-6	Violeta	10	100
10204587	317-1	Amarillo	10	100

• Lumocolor 318 F

Código	Ref.	Color	U/Vta	U/Emb
10204504	318-1	Amarillo	10	100
10204505	318-4	Naranja	10	100
10204506	318-6	Violeta	10	100
10204507	318-7	Marrón	10	100
10204013	318-3	Azul	10	100
10204014	318-9	Negro	10	100
10204015	318-2	Rojo	10	100
10204016	318-5	Verde	10	100



Carcasa fabricada con 97% de plástico reciclado

Rotulador Permanente 319 Lumocolor Special negro

Código	Ref.	U/Vta	U/Emb
10204572	319 F-9	10	100



Rotulador permanente 317 Lumocolor (M)

Código	Ref.	Caja	U/Vta	U/Emb
10204300	317 C6	6 uds	1	10
10204298	317 C10	10 uds	1	10
10204299	317 C14	14 uds	1	10



Rotulador permanente 318 Lumocolor (F)

Código	Ref.	Caja	U/Vta	U/Emb
10204303	318 C6	6 uds	1	10
10204301	318 C10	10 uds	1	10
10204302	318 C14	14 uds	1	10



Rotulador permanente 318 Eco Lumocolor (F) Caja de 6

Código	Ref.	U/Vta	U/Emb
10204906	318 C6-1	1	10



Rotulador permanente Lumocolor 313-317-318 Expositor de 60

Código	Ref.	U/Vta	U/Emb
10204908	31 CA120	1	1



Marcador permanente 352 Lumocolor cónico

Código	Ref.	Estuche	U/Vta	U/Emb
10204594	352 WP4	4 uds	2	10
10201116	352 WP8	8 uds	1	10



Marcador tiza líquida Chalk Marker 344

Código	Ref.	Estuche	U/Vta	U/Emb
10203971	344 C4	6 uds	1	1
10203972	344 C8	8 uds	1	1



Marcador tiza líquida Chalk Marker 344

Código	Ref.	Estuche	U/Vta	U/Emb
10203969	349 C6	6 uds	1	1
10203970	349 C10	10 uds	1	1



Marcador tinta opaca no permanente metálico
Blíster de 10

Código	Ref.	Artículo	U/Vta	U/Emb
10203794	8321 TB10	Punta pincel	1	10
10203795	8323 TB10	Punta cónica	1	10



Marcador tinta opaca no permanente 8323 Metálico

Código	Ref.	Modelo	U/Vta	U/Emb
10203598	8323-S BK3	Blíster 3	1	10
10204672	8323-S BK5	Blíster 5	1	10
10202489	8323-SWP6P	Blíster 6	5	6



Marcador 8323 metálico
Tinta opaca no permanente
Expositor de 70

Código	Ref.	U/Vta	U/Emb
10204309	8323-SCA70	1	1



Afilalápiz metálico Cuña

Código	Ref.	Usos	U/Vta	U/Emb
13701083	510 10 1	20	20	20
13701084	510 20 2	20	20	20



Afilalápiz metálico cuña
colores surtidos

Código	Ref.	Usos	U/Vta	U/Emb
13701145	510 10 PR2 1	20	20	20
13701147	510 20 PR2 2	20	20	20



GRAN CAPACIDAD

Afilalápiz 511 con depósito gran capacidad amarillo/negro
Expositor 12

Código	Ref.	U/Vta	U/Emb
13701219	511 120	1	1



Afilalápiz depósito transparente
Expositor de 10 (4 colores)

Código	Ref.	Usos	U/Vta	U/Emb
13701752	511 006 1	1	1	1
13701753	512 006 2	1	1	1



Portaminas 788
Mars Technico 2,0 mm

Código	Ref.	U/Vta	U/Emb
24302083	788 C 1	1	100

Minas 257 Polo 0,5 HB
Tubo de 12 minas

Código	Ref.	U/Vta	U/Emb
21901069	257 05-HB 1	1	60



Minas 250 Mars Micro Carbón
Cajas de 12 uds y expositor

Código	Ref.	Tipo / grosor	U/Vta	U/Emb
21901015	250-03-HB	0,3 - HB	12	60
21901016	250-05-2B	0,5 - 2B	12	60
21901017	250-05-2H	0,5 - 2H	12	60
21901018	250-05-3H	0,5 - 3H	12	60
21901022	250-05-B	0,5 - B	12	60
21901023	250-05-F	0,5 - F	12	60
21901024	250-05-H	0,5 - H	12	60
21901025	250-05-HB	0,5 - HB	12	60
21901026	250-07-H	0,7 - H	12	60
21901027	250-07-HB	0,7 - HB	12	60
21901031	250-07-2B	0,7 - 2B	12	60
21901032	250-07-2H	0,7 - 2H	12	60
21901003	250-07-B	B 0,7 - B	12	60
21901013	250-09-HB	0,9 - HB	12	60
21901049	250-09-B	0,9 - B	12	60
21901095	250 CA12	Expositor de 144	1	1



Boligrafo retráctil 421 Elance

Código	Ref.	Estuche	U/Vta	U/Emb
10101836	421 45-17	Beige	10	250
10101837	421 45-20	Rosa	10	250
10101838	421 45-35	Turquesa	10	250
10101839	421 45-39	Azul pacífico	10	250
10101840	421 45CA20	Expositor de 20	1	1



Gomas Rasoplast

Código	Ref.	U/Vta	U/Emb
11101124	526 B30	30	30



Gomas Mars Plastic

Código	Ref.	U/Vta	U/Emb
11101081	526 50	20	20

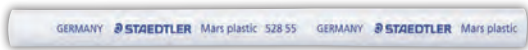

**Recambio Portagomas
Caja 10 Uds**

Código	Ref.	U/Vta	U/Emb
25408003	528 55	10	100



**Goma de borrar 526 50 mars plastic
Expositor de 40**

Código	Ref.	U/Vta	U/Emb
11101015	526 50CA40	1	1



**Portagomas 528 50 Mars Plastic
Expositor de 20**

Código	Ref.	U/Vta	U/Emb
24315007	528 50 CA	1	1



**Compás con patillas Mars Quickbow
Con tubo de minas y adaptador universal**

Código	Ref.	Artículo	U/Vta	U/Emb
16301005	552 01	Sin alargadera	1	5
16301129	552 02	Con alargadera	1	5



Compás Ciclo 554 00T

Código	Ref.	U/Vta	U/Emb
16301089	554 T01	1	5



Compás 556 neón

Código	Ref.	U/Vta	U/Emb
16301248	556 00-N2	1	5



Compás 556 pastel

Código	Ref.	Color	U/Vta	U/Emb
16301062	556 00-PA1	Azul/menta	1	5
16301063	556 00-PA2	Rosa/Lila	1	5



**Compás 550 50
Con Tubo Minas**

Código	Ref.	U/Vta	U/Emb
16301144	550 50	1	20



**Compás 550 60 Minas y
adaptador universal**

Código	Ref.	U/Vta	U/Emb
16301145	550 60	1	20



Compás 550 01 adaptador

Código	Ref.	U/Vta	U/Emb
16301142	550 01	1	10



**Compás 550 02 con adaptador +
Alargadera**

Código	Ref.	U/Vta	U/Emb
16301143	550 02	1	10

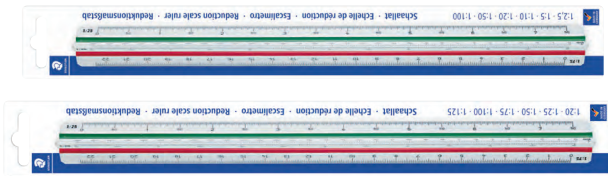

Escalímetro 30cm

Código	Ref.	Escala	U/Vta	U/Emb
28601021	561 98-1BK	1:20,1:25,1:50,1:75,1:100,1:125	1	6
28601022	561 98-2BK	1:20,1:25,1:33-1/3,1:50,1:75,1:100	1	6
28601005	561 98-4BK	1:100,1:200,1:250,1:300,1:400,1:500	1	6
28601023	56198DINBK	1:2,5,1:5,1:10,1:20,1:50,1:100	1	6



Reglas de 30cm

Código	Ref.	U/Vta	U/Emb
25501006	562 04-30S	10	10



Tijeras escolares 10cm

Código	Ref.	U/Vta	U/Emb
27601210	965 40 BK	1	10



Tijeras escolares Noris

Código	Ref.	Artículo	U/Vta	U/Emb
27601233	965 14 NBK	14 cm	1	10
27601234	965 14LNBK	14 cm Zurdos	1	10
27601235	965 17 NBK	17 cm	1	10
27601206	965 21NBK	21 cm	1	10

GAMA *Discover & Create* Design Journey Artística *Draw - Write - Paint*



Lápices de colores Design Journey 149 Super Soft Estuche de metal

Código	Ref.	Estuche	U/Vta	U/Emb
12802109	149C M12	12 uds	3	10
12802110	149C M24	24 uds	1	5



Lápices de colores Design Journey 146 Estuche de metal

Código	Ref.	Estuche	U/Vta	U/Emb
12802105	146C M12	12 uds	1	10
12802106	146C M24	24 uds	1	5



Lápices de colores Design Journey 146 Estuche de metal 12 colores metálicos

Código	Ref.	U/Vta	U/Emb
12802541	146M M12	1	10



Lápices acuarelabes Design Journey 14610 Estuche de metal

Código	Ref.	Estuche	U/Vta	U/Emb
12802107	14610C M12	12 uds	1	10
12802108	14610C M24	24 uds	1	5



Rotulador permanente doble punta 3187 Design Journey

Código	Ref.	Estuche	U/Vta	U/Emb
10202840	3187 TB18	18 uds	1	6
10202841	3187 TB36	36 uds	1	6



Rotulador de fibra doble punta pincel acuarelable 3001 Design Journey

Código	Ref.	Estuche	U/Vta	U/Emb
10202835	3001 TB18	18 uds	1	6
10202836	3001 TB36	36 uds	1	6



Rotulador de fibra doble punta 3200 Design Journey

Código	Ref.	Estuche	U/Vta	U/Emb
10202842	3200 TB36	36 uds	1	5
10202843	3200 TB72	72 uds	1	4



Ceras pastel al óleo 2420 Design Journey

Código	Ref.	Estuche	U/Vta	U/Emb
16001107	2420 C24	24 uds	1	12
16001108	2420 C48	48 uds	1	1



Ceras óleo pastel 2420 Design Journey
Estuche de 6 colores metálicos

Código	Ref.	U/Vta	U/Emb
16001530	2420M C6-C	1	10



Ceras pastel suaves 2430 Design Journey

Código	Ref.	Estuche	U/Vta	U/Emb
16001109	2430 C24	24 uds	1	6
16001110	2430 C48	48 uds	1	2



Ceras acuarelables 223 Design Journey

Código	Ref.	Estuche	U/Vta	U/Emb
16001105	223 C12	12 uds	1	6
16001106	223 C24	24 uds	1	6



Acuarelas 8880 Design Journey

Código	Ref.	Estuche	U/Vta	U/Emb
13501111	8880 C12	12 uds	1	6
13501112	8880 C24	24 uds	1	6



Pincel 989 escolar Design Journey
Blíster de 3
(redondo n°2-n°8, plano n°8)

Código	Ref.	U/Vta	U/Emb
12301243	989-SBK3-3	1	6



Pincel de agua 949 Design Journey
Punta redondo fino

Código	Ref.	U/Vta	U/Emb
12301215	949 BK-1-C	12	288



Pintura acrílica 8500 tubo de 12ml

Código	Ref.	Estuche	U/Vta	U/Emb
23501497	8500 C12	12 Uds	1	6
23501498	8500 C24	24 Uds	1	24



Difumino. Blíster de 4
(Grosor número 1,4,6 y 8)

Código	Ref.	U/Vta	U/Emb
17601006	5426-S BK4	10	10



Goma de borrar artística 5427
(amasable + limpieza)

Código	Ref.	U/Vta	U/Emb
11101274	5427SBK2-C	6	6



Lápiz de grafito acuarelable
100A Lumograph Aquarell
Blíster de 3

Código	Ref.	U/Vta	U/Emb
12802012	100A SBK4	1	10



Lápiz de carboncillo
100C Lumograph Charcoal
Blíster de 3

Código	Ref.	U/Vta	U/Emb
12802016	100C SBK4	1	10



Lápiz de grafito
100B Lumograph Black
Caja metal de 6 lápices

Código	Ref.	U/Vta	U/Emb
12801468	100B G6	6	6



Lápiz grafito 100% mina (sin madera)
100G Lumograph Pure graphite
Caja de metal de 6

Código	Ref.	U/Vta	U/Emb
12802077	100G M6	1	10



Lápiz pastel
100P Lumograph Pastel
Blíster de 6

Código	Ref.	U/Vta	U/Emb
12802078	100P-SBK6	1	10



Ecolápiz de grafito Grip 2001

Código	Ref.	Artículo	U/Vta	U/Emb
12801278	117000	HB	12	12
12801626	117001	B	12	12
12801433	117002	2B	12	12
12801627	117011	H	12	12
12801443	117012	2H	12	12



Ecolápiz de grafito B Jumbo Grip

Código	Ref.	U/Vta	U/Emb
12801277	111900	12	12



Ecolápiz de grafito B Grip 2001 con goma

Código	Ref.	Artículo	U/Vta	U/Emb
12802467	117200	HB	12	12
12802468	117201	H	12	12



Ecolápiz Goldfaber 1221

Código	Ref.	Artículo	U/Vta	U/Emb
12801050	112500	HB	12	12
12801049	112501	B	12	12
12801042	112502	2B	12	12
12801053	112503	3B	12	12
12801083	112504	4B	12	12
12801232	112505	5B	12	12
12801218	112506	6B	12	12
12801041	112511	H	12	12
12801043	112512	2H	12	12
12801123	112513	3H	12	12
12801047	112514	4H	12	12



Ecolápiz Castell 9000 Grafito

Código	Ref.	Artículo	U/Vta	U/Emb
12801391	119000	HB	12	12
12801392	119001	B	12	12
12801115	119002	2B	12	12
12801400	119003	3B	12	12
12801219	119004	4B	12	12
12801014	119005	5B	12	12
12801221	119006	6B	12	12
12801223	119007	7B	12	12
12801224	119008	8B	12	12
12801113	119010	F	12	12
12801114	119011	H	12	12
12801086	119012	2H	12	12
12801080	119013	3H	12	12
12801220	119014	4H	12	12
12801071	119015	5H	12	12
12801222	119016	6H	12	12



Ecolápiz Bicolor

Código	Ref.	Artículo	U/Vta	U/Emb
12801020	117500	Grueso 873	12	12
12801019	116000	Fino Janus 2160	12	12



Lápiz Bicolor Fino Janus 2160 Expositor de 120

Código	Ref.	U/Vta	U/Emb
12801890	1160120S	1	1



Lápiz de grafito Goldfaber 1221 Expositor de 120

Código	Ref.	U/Vta	U/Emb
12801889	1125120S	1	1

Contenido:
 20x 112500 - HB
 20x 112501 - B
 20x 112502 - 2B
 20x 112503 - 3B
 20x 112504 - 4B
 20x 112512 - 2H



36x Plateados
 36x Rosados

Lápiz de grafito Grip 2001 B con goma Bote de 72

Código	Ref.	U/Vta	U/Emb
12802543	217272	1	1



Afilalápiz con depósito
Expositor de 25

Código	Ref.	U/Vta	U/Emb
13701775	30581526/125-LV	1	1



Afilalápiz 2 usos con depósito
Expositor de 12

Código	Ref.	U/Vta	U/Emb
13701266	183103	1	1



Afilalápiz RollOn Sparkle 2 usos
con depósito
Caja de 6 (3 colores)

Código	Ref.	U/Vta	U/Emb
13701288	183900	1	1



Afilalápiz RollOn Dots 2 usos
con depósito
Caja de 6 (2 colores)

Código	Ref.	U/Vta	U/Emb
13701287	183910	1	1



Afilalápiz Trío Grip 3 usos

Código	Ref.	Colores	U/Vta	U/Emb
13701049	183800	Gris	10	10
13701067	183801	Surtidos	10	10



Goma de borrar Dust-Free
Caja surtida de 30 (3 colores)

Código	Ref.	U/Vta	U/Emb
11101223	187219	1	1



Goma de borrar para lápiz
Libre de PVC

Código	Ref.	Modelo	U/Vta	U/Emb
11101218	188121	188121	20	20
11101356	187120	187120	20	20



Goma de borrar 7095
Libre de PVC

Código	Ref.	U/Vta	U/Emb
11101208	189520	20	600



Goma de borrar 587122
para artistas
Libre de PVC

Código	Ref.	U/Vta	U/Emb
11101355	587122	20	20



Goma de borrar 7020 moldeable
Para carboncillo y pastel

Código	Ref.	U/Vta	U/Emb
11101177	127154	1	18



Goma de borrar gris 127220 moldeable
Para carboncillo y pastel

Código	Ref.	U/Vta	U/Emb
11101357	127220	18	18



Goma de borrar RollOn Sparkle
Caja de 20 (3 colores)

Código	Ref.	U/Vta	U/Emb
11101386	187310	1	1



Goma de borrar RollOn blanca
Caja de 20

Código	Ref.	U/Vta	U/Emb
11101387	187320	1	1



Roller tinta líquida Micro 0,5mm

Código	Ref.	Color	U/Vta	U/Emb
11201242	348601	Azul	12	12
11201243	348602	Negro	12	12
11201244	348603	Rojo	12	12
11201245	348604	Verde	12	12

**Roller tinta líquida Micro 0,5mm
Expositor de 40**

Código	Ref.	U/Vta	U/Emb
11201210	348630	1	10



Roller tinta líquida Fine 0,7mm

Código	Ref.	Color	U/Vta	U/Emb
11201239	348251	Azul	12	12
11201241	348299	Negro	12	12
11201238	348221	Rojo	12	12
11201240	348263	Verde	12	12

**Roller tinta líquida Fine 0,7mm
Expositor de 40**

Código	Ref.	U/Vta	U/Emb
11201209	348230	1	10



Roller tinta líquida Free Ink Broad 1,5mm

Código	Ref.	Color	U/Vta	U/Emb
11201228	348351	Azul	12	12
11201229	348399	Negro	12	12
11201230	348321	Rojo	12	12
11201236	348363	Verde	12	12
11201237	348366	Verde claro	12	12
11201235	348347	Azul claro	12	12
11201231	348315	Naranja	12	12
11201232	348326	Rojo vino	12	12
11201234	348328	Rosa	12	12
11201233	348336	Violeta	12	12



Roller Fast Gel 0,7mm

Código	Ref.	Color	U/Vta	U/Emb
11201254	641751	Azul	10	10
11201255	641799	Negro	10	10
11201253	641721	Rojo	10	10
11201248	640903	Verde	10	10
11201249	640904	Verde claro	10	10
11201251	640906	Lila	10	10
11201250	640905	Naranja	10	10
11201247	640902	Oro	10	10
11201246	640901	Rosa	10	10
11201252	640907	Turquesa	10	10



**Roller Fast Gel 0,7mm
Expositor de 40**

Código	Ref.	U/Vta	U/Emb
11201211	640141	1	1



**Roller tinta líquida Free Ink Broad 1,5mm
Expositor de 40**

Código	Ref.	U/Vta	U/Emb
11201208	348330	1	10



Roller Gel Free Ink 0,5mm

Código	Ref.	Color	U/Vta	U/Emb
10101488	348501	Azul	12	12
10101489	348502	Negro	12	12
10101490	348503	Rojo	12	12
10101491	348504	Verde	12	12

Roller Gel Free Ink 0,7mm

Código	Ref.	Color	U/Vta	U/Emb
10101484	348151	Azul	12	12
10101487	318199	Negro	12	12
10101479	348121	Rojo	12	12
10101485	348163	Verde	12	12
10101486	348166	Verde claro	12	12
10101483	348147	Azul cielo	12	12
10101478	348115	Naranja	12	12
10101480	348126	Rojo vino	12	12
10101481	348128	Rosa	12	12
10101482	348136	Violeta	12	12



Contiene:
23x azul
10x negro
5x rojo
2x verde

Contiene:
23x azul
10x negro
5x rojo
2x verde



Contiene:
4x naranja
4x rojo
4x rojo vino
4x rosa
4x violeta
4x azul cielo
4x azul
4x verde
4x verde claro
4x negro

**Roller Gel Free Ink 0,5mm
Expositor de 40 (36 + 4 gratis)**

Código	Ref.	U/Vta	U/Emb
10101257	140093-1	1	10

**Roller Gel Free Ink 0,7mm
Expositor de 40 (36 + 4 gratis)**

Código	Ref.	U/Vta	U/Emb
10101258	140093-2	1	10



**Roller Gel Free Ink 0,7mm
Expositor de 40 (36 + 4 gratis)**

Código	Ref.	U/Vta	U/Emb
10101259	140093-3	1	10



Ecolápiz Acuarelables Colour Grip
Fabricados en Alemania a partir de madera gestionada de forma sostenible.

Código	Ref.	Estuche	U/Vta	U/Emb
12801329	112412	12 uds	1	5
12801330	112424	24 uds	1	3



Estuche 12 Ecolápices de Color Jumbo Grip
Para niños de más de 3 años.

Código	Ref.	U/Vta	U/Emb
12801183	110912	1	3



Ecolápiz Color Acuarelables
Fabricados en madera 100% reforestada gestionada de forma sostenible.

Código	Ref.	Estuche	U/Vta	U/Emb
12801127	114413	12 uds	1	12
12801128	114425	24 uds	1	6
12802102	114437	36 uds	3	6
12802103	114448	48 uds	3	6



Caja de Ecolápiz de Color. Fabricados en madera 100% reforestada gestionada de forma sostenible.

Código	Ref.	Estuche	U/Vta	U/Emb
12801133	120112	12 uds	1	12
12801134	120124	24 uds	1	6
12801585	120136	36 uds	1	6
12801658	120148	48 uds	1	6
12802104	111260	60 uds	1	1



Caja de metal Ecolápiz de Color

Código	Ref.	Estuche	U/Vta	U/Emb
12801702	115801	12 uds	1	5
12801703	115824	24 uds	1	3
12801704	115886	36 uds	1	3



Lápices de colores bicolor
Estuche de 8 (16 colores)

Código	Ref.	U/Vta	U/Emb
12801132	116197	1	12



Lápices de colores estuche de metal

Código	Ref.	Estuche	U/Vta	U/Emb
12801955	115888	48 uds	1	1
12801956	115894	60 uds	1	1



Lápices de colores estuche de 12+3 bicolor

Código	Ref.	U/Vta	U/Emb
12801954	110312	1	12



Lápices de colores Black Edition

Código	Ref.	Estuche	U/Vta	U/Emb
12802404	116412	12 uds	2	5
12802405	116424	24 uds	2	3
12802406	116436	36 uds	2	3
12802545	116411	100 uds	1	1



Lápices de colores Black Edition Skin Tones Estuche de 12

Código	Ref.	U/Vta	U/Emb
12802544	116414	5	5



Rotuladores de fibra Black Edition pincel * Colores pastel.

Código	Ref.	Estuche	U/Vta	U/Emb
10204973	116453	6 uds*	6	6
10204971	116451	10 uds	6	6
10204972	116452	20 uds	3	6



Rotulador de fibra lavable

Código	Ref.	Caja	U/Vta	U/Emb
10201335	554201	12 uds	1	10
10201336	554202	24 uds	1	6
10201337	554203	36 uds	1	6
10201171	554204	50 uds	1	6



Rotuladores de colores Grip 1553 Tinta a base de colorantes alimenticios y agua

Código	Ref.	Artículo	U/Vta	U/Emb
10205204	155310	10 uds	1	10



Rotulador de fibra doble punta * Colores pastel.

Código	Ref.	Estuche	U/Vta	U/Emb
10205285	151110	10 uds	1	10
10204969	151112	10 uds*	1	10
10202502	151119	20 uds	1	5
10204970	151140	40 uds	1	1



Rotulador fibra Jumbo

Código	Ref.	Caja	U/Vta	U/Emb
10201338	554312	12 uds	1	12
10201339	554324	24 uds	1	6



Rotulador de fibra Connector Maletín de 80

Código	Ref.	U/Vta	U/Emb
10202501	155579	1	200



Acuarelas Estuche de 12

Código	Ref.	U/Vta	U/Emb
13501216	125018	6	6



Marcador Fluorescente Textliner 48
Tres trazos: 5 mm, 2 mm y 1 mm. Rellenable.

Código	Ref.	Artículo	U/Vta	U/Emb
10202010	154815	Naranja	10	200
10202013	154821	Rojo	10	200
10202014	154828	Rosa	10	200
10202015	154851	Azul	10	200
10202016	154863	Verde	10	200
10202003	154807	Amarillo	10	200



Marcador flúor textliner 48

Hasta fin de existencias

Código	Ref.	Artículo	U/Vta	U/Emb
10202750	254831	Estuche 3+1	1	1
10202728	254830	Expositor 66 + 22 Sin cargo	1	1

Marcadores fluorescentes Textliner Expositor surtido

Código	Ref.	Uds	U/Vta	U/Emb
10202459	254820	120	1	1
10202027	154833	60	1	1



Marcador flúor Textliner 1546 pastel

Código	Ref.	Color	U/Vta	U/Emb
10202225	154654	Rosa	10	50
10202226	154655	Albaricoque	10	50
10202227	154656	Lila	10	50
10202228	154657	Azul pálido	10	50
10202229	154658	Turquesa	10	50
10203084	154666	Verde claro	10	50
10203085	154667	Vainilla	10	50
10203086	154668	Azul ultramar	10	50



Marcador Flúor Textliner 1546 Rellenables excepto el color violeta

Código	Ref.	Artículo	U/Vta	U/Emb
10202769	154607	Amarillo	10	50
10202770	154615	Naranja	10	50
10202771	154621	Rojo	10	50
10202772	154628	Rosa	10	50
10202773	154636	Violeta	10	50
10202774	154652	Azul	10	50
10202775	154663	Verde	10	50



5x gris seda
10x rosa
5x albaricoque
10x lila
5x turquesa
5x verde claro
10x vainilla
5x azul ultramar
5x azul pálido



Marcador Textliner 1546 pastel Expositor surtido de 60

Código	Ref.	U/Vta	U/Emb
10203646	254633	1	1



Marcador Fluorescente Textliner 1546 metálico
Tres trazos: 5 mm, 2 mm y 1 mm.

Código	Ref.	Artículo	U/Vta	U/Emb
10203385	154626	Oro rosa	10	50
10203386	154650	Oro	10	50
10203387	154661	Plata	10	50
10203388	154691	Rubí	10	50
10203641	154639	Verde	10	50
10203642	154647	Azul	10	50
10203643	154673	Rojo	10	50
10203644	154678	Violeta	10	50



Marcador Textliner 1546 metálico
Pack de 4

Código	Ref.	Artículo	U/Vta	U/Emb
10203638	154623	● ● ● ●	1	5
10203639	154624	● ● ● ●	1	5



Marcador Textliner 1546 metálico
Serie Roja Pack de 4

Código	Ref.	U/Vta	U/Emb
10203389	154640	1	5



Marcador Textliner Serie Roja 1546 metálico
Pack de 8

Código	Ref.	U/Vta	U/Emb
10203647	154689	1	5

Contienen:
1x Oro rosa
1x Oro
1x Plata
1x Rubí
1x Verde
1x Azul
1x Rojo
1x Violeta



Marcador Textliner 1546 metálico
Pack de 8

Código	Ref.	U/Vta	U/Emb
10203640	154625	1	5



Contiene:
10x Verde
10x Azul
10x Rojo
10x Violeta
20x Plata
20x Oro
10x Oro rosa
10x Rubí

Marcador Creative Studio 1546
Expositor surtido de 100

Código	Ref.	U/Vta	U/Emb
10203645	154618	1	1



Marcador flúor Textliner 38

Código	Ref.	Artículo	U/Vta	U/Emb
10202751	157707	Amarillo	10	10
10202752	157715	Naranja	10	10
10202753	157721	Rojo	10	10
10202754	157728	Rosa	10	10
10202755	157736	Violeta	10	10
10202756	157751	Azul	10	10
10202757	157763	Verde	10	10



Portaminas Grip Plus 1307 0,7 mm

Código	Ref.	Color	U/Vta	U/Emb
24302348	130732	Azul	5	5
24302350	130733	Negro	5	5



Minas Super-Polymer HB
Tubo de 12 minas

Código	Ref.	Artículo	U/Vta	U/Emb
21901107	120700	0,7 mm	12	12
21901114	120500	0,5 mm	12	12



Portaminas TK®-Fine

Código	Ref.	Artículo	U/Vta	U/Emb
24302268	136300	0,35 mm	10	10
24302269	136500	0,5 mm	10	10
24302270	136700	0,7 mm	10	10
24302271	136900	1,0 mm	10	10



5x Plateado
5x Azul metálico
5x Negro mate



Portaminas Grip 2011 0,7mm
Expositor de 15

Código	Ref.	U/Vta	U/Emb
30301978	131230	1	1



Portaminas Grip-Matic 0,7mm
Expositor de 40

Código	Ref.	U/Vta	U/Emb
24302245	137741	1	1



Rotulador Permanente Multimark S (0,4 mm)

Código	Ref.	Artículo	U/Vta	U/Emb
10205321	152351	Azul	10	360
10205322	152399	Negro	10	360
10205320	152321	Rojo	10	360



Rotulador Permanente Multimark F (0,6 mm)

Código	Ref.	Artículo	U/Vta	U/Emb
10205316	151351	Azul	10	360
10205136	151399	Negro	10	360
10205315	151321	Rojo	10	360



Rotulador Permanente Multimark S (0,4mm)

Código	Ref.	Artículo	U/Vta	U/Emb
10205323	152304	Bolsa de 4	1	5
10205325	152309	Bolsa de 8	1	5



Rotulador Permanente Multimark M (1,0 mm)

Código	Ref.	Artículo	U/Vta	U/Emb
10205327	152551	Azul	10	360
10205328	152599	Negro	10	360
10205326	152521	Rojo	10	360



**Lápices acuarelables Goldfaber Aqua
1146 Estuche de metal**

Código	Ref.	Estuche	U/Vta	U/Emb
12801958	114612	12 uds	5	5
12801959	114624	24 uds	3	3
12801960	114636	36 uds	3	3
12801961	114648	48 uds	1	1



**Lápices Goldfaber 1147
Estuche de metal**

Código	Ref.	Estuche	U/Vta	U/Emb
12801962	114712	12 uds	5	5
12801963	114724	24 uds	3	3
12801964	114736	36 uds	3	3
12801965	114748	48 uds	1	1



**Lápiz de colores Goldfaber 1147
Enrollable de 27**

Código	Ref.	U/Vta	U/Emb
12802101	114752	1	1



Tiza pastel blanda Creative Studio

Código	Ref.	Caja	U/Vta	U/Emb
27901041	128312	12 uds	5	10
27901038	128324	24 uds	3	12



**Tiza pastel blanda mini
Caja de 24**

Código	Ref.	U/Vta	U/Emb
27901043	128224	5	5



**Ceras pastel Creative Studio oil
Caja de 12**

Código	Ref.	U/Vta	U/Emb
16001433	127012	1	6



Lápices Grafito Creative Studio

Código	Ref.	Estuche	U/Vta	U/Emb
12801966	114000	8 uds	1	6
12801967	114002	7 uds	1	6
12801968	114004	6 uds	1	6



Acuarelas Creative Studio

Código	Ref.	Estuche	U/Vta	U/Emb
13501182	169724	24 uds	1	8
13501183	169736	36 uds	1	8
13501184	169748	48 uds	1	8



Estuche Rotuladores Grip Finepen 1516 trazo de 0,4mm

Código	Ref.	Estuche	U/Vta	U/Emb
10205449	151610	10 uds	1	10
10205450	151620	20 uds	1	5

Rotulador de fibra Pitt Hand Lettering

Código	Ref.	Bolsa	Colores	U/Vta	U/Emb
10202503	267115	4 uds	●●●●●	1	5
10202504	267116	6 uds	●●●●●●	1	5
10202505	267117	6 uds	●●●●●●	1	5
10202506	267118	7 uds	●●●●●●●	1	5

Rotuladores de fibra Grip Finepen 1516 Pack de 5

Código	Ref.	Estuche	U/Vta	U/Emb
10204961	151602	6 uds	1	12
10204962	151603	12 uds	1	12
10204963	151604	18 uds	1	12



Nuevos estuches

Rotuladores acquarelables Goldfaber Aqua Dual Markers Estuche de 6

Código	Ref.	Artículo	U/Vta	U/Emb
10204315	164528	Candy	1	5
10204316	164527	Flowers	1	5
10204317	164521	Tuscany	1	5
10204318	164526	Fantasy	1	5
10204319	164525	Graffiti	1	5
10204320	164524	Lettering	1	5
10204321	164523	Portrait	1	5
10204322	164522	Shades of grey	1	5
10204960	164517	Jungle	1	5
10204959	164518	Boho	1	5
10204958	164519	Sea	1	5



Rotulador de fibra Pitt Estuche de 4 (oro, plata, rubí y azul)

Código	Ref.	U/Vta	U/Emb
10202507	167304	1	5



Rotuladores acquarelables Goldfaber Aqua Dual Markers

Código	Ref.	Estuche	U/Vta	U/Emb
10204323	164606	6 uds	1	5
10204325	164612	12 uds	1	3
10204324	164618	18 uds	1	3
10204314	164624	24 uds	1	1
10204326	164660	Expositor de 300	1	1

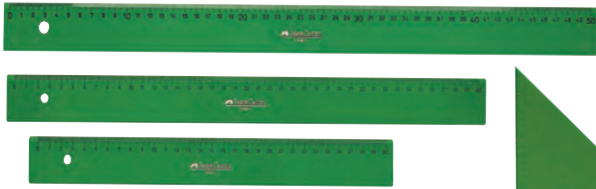

Regla polipropileno, color verde transparente

Código	Ref.	Artículo	U/Vta	U/Emb
25501011	813	30 cm	1	10
25501012	814	40 cm	1	10
25501013	815	50 cm	1	10
25501014	816	60 cm	1	5

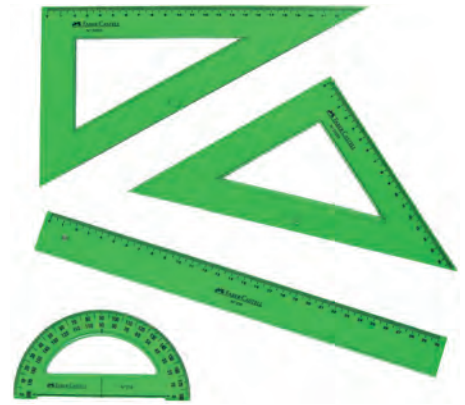
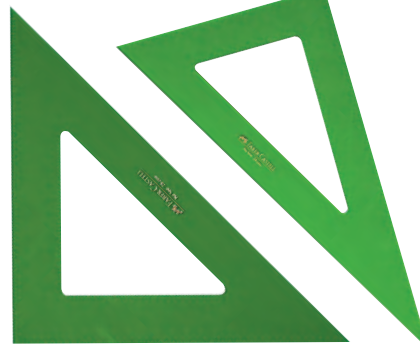

Instrumentos de medida polipropileno, color verde transparente

Código	Ref.	Tamaño	Artículo	U/Vta	U/Emb
18401010	56625	25 cm	Escuadra	1	5
18401011	56628	28 cm	Escuadra	1	10
18401012	56632	32 cm	Escuadra	1	10
18403010	66625	25 cm	Cartabón	1	5
18403011	66628	28 cm	Cartabón	1	10
18403012	66632	32 cm	Cartabón	1	10



Juego escolar 30cm

Código	Ref.	U/Vta	U/Emb
18402002	65021	1	10

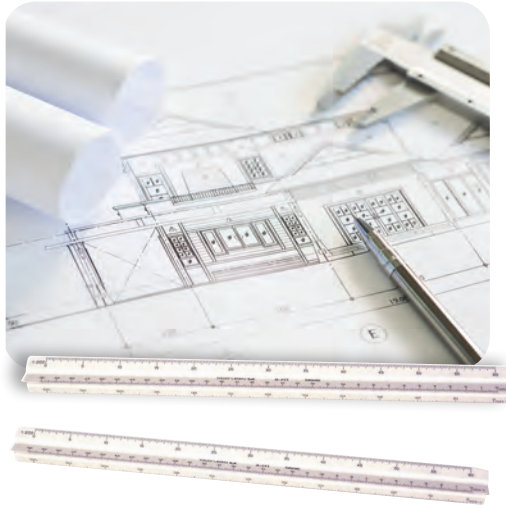

Escalímetro escolar de plástico 30 cm.

Código	Ref.	Tipo	U/Vta	U/Emb
28601003	176151	153 A	1	15
28601006	176152	153 B	1	15



Tinta estilográfica
Caja de 6 cartuchos

Código	Ref.	Color	U/Vta	U/Emb
10601248	185506	Azul real	1	10
10601249	185507	Negro	1	10



Compás Trend Urban Look
ajuste rápido surtido

Código	Ref.	U/Vta	U/Emb
16301095	574443	5	5



Compás Trend Future Look
ajuste rápido surtido

Código	Ref.	U/Vta	U/Emb
16301097	574453	5	5



Compás ajuste rápido

Código	Ref.	U/Vta	U/Emb
16301195	327228	1	5



Compás Stream 2019 con ajuste
rápido color piedra negra

Código	Ref.	U/Vta	U/Emb
16301054	174530	1	5



Compás escolar 3 colores surtidos

Código	Ref.	U/Vta	U/Emb
16301050	174100	1	5



Compás Factory azul perlado
ajuste rápido

Código	Ref.	U/Vta	U/Emb
16301067	174340	1	3



Lápiz de grafito de madera HB
Colores metálicos

Código	Ref.	U/Vta	U/Emb
12802187	2090067	72	72



Lápiz de grafito Exam de madera 2B

Código	Ref.	U/Vta	U/Emb
12802407	2090068	72	1080



Boligrafo multifunción 600 (3 en 1)
boligrafo azul, rojo y portaminas

Código	Ref.	Color	U/Vta	U/Emb
30302258	2164108	Negro	1	1
30302256	2164109	Plateado	1	1



Rotulador de fibra fineliner

Código	Ref.	Blister	U/Vta	U/Emb
10204822	2166331	4 uds	12	12
10204821	2166220	10 uds	12	12



Compás con adaptador universal
+ alargadera

Código	Ref.	U/Vta	U/Emb
16301147	S0676540	12	1



Compás Compact con adaptador universal,
alargadera, minas y agujas de respuesto

Código	Ref.	U/Vta	U/Emb
16301077	S0676560	1	1



Compás Compact micrométrico
ajuste rápido

Código	Ref.	U/Vta	U/Emb
16301059	S0676580	1	1



Vector XL

• Roller

Código	Ref.	Color	U/Vta	U/Emb
30301932	2159776	Azul	1	1
30301931	2159775	Azul plata	1	1
30301934	2159778	Lila	1	1
30301930	2159774	Negro	1	1
30301933	2159777	Verde	1	1

• Pluma fina

Código	Ref.	Color	U/Vta	U/Emb
30301927	2159761	Azul	1	1
30301926	2159750	Azul plata	1	1
30301929	2159763	Lila	1	1
30301925	2159749	Negro	1	1
30301928	2159762	Verde	1	1



Boligrafo Jotter Plastic Originals
Expositor de 20

Código	Ref.	U/Vta	U/Emb
30301634	2075422	1	1



Boligrafo Jotter Original
Expositor de 20 (4uds x 5 colores)

Código	Ref.	Artículo	U/Vta	U/Emb
30301952	2162143	Glam Rock	1	1
30302499	2186316	Retro Wave	1	1

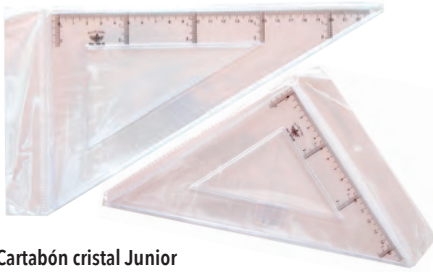

Cartabón cristal Junior

Código	Ref.	Tamaño	U/Vta	U/Emb
18403001	104120	20 cm	20	20
18403002	104125	25 cm	20	20
18403005	104130	30 cm	20	20
18403006	104135	35 cm	20	20

Escuadra cristal Junior

Código	Ref.	Tamaño	U/Vta	U/Emb
18401001	103120	20 cm	20	20
18401002	103125	25 cm	20	20
18401005	103130	30 cm	20	20
18401006	103135	35 cm	20	20



Semicírculos

Código	Ref.	Tamaño	U/Vta	U/Emb
26101002	105010	10 cm	20	20
26101003	105013	13 cm	20	20



Reglas metálicas

Código	Ref.	Tamaño	U/Vta	U/Emb
25501095	612015	15 cm	1	24
25501096	612030	30 cm	1	24
25501097	612040	40 cm	1	24
25501098	612050	50 cm	1	24
25501099	612060	60 cm	1	24
25501100	612080	80 cm	1	24
25501101	612100	100 cm	1	12



Reglas cristal Junior

Código	Ref.	Tamaño	U/Vta	U/Emb
25501000	101020	20 cm	20	20
25501001	101030	30 cm	20	20
25501002	101040	40 cm	20	20
25501003	101050	50 cm	20	20
25501022	101060	60 cm	20	20



Regla cristal zurdos Junior

Código	Ref.	Tamaño	U/Vta	U/Emb
25501398	101028Z	20 cm	10	10
25501399	101038Z	30 cm	10	10

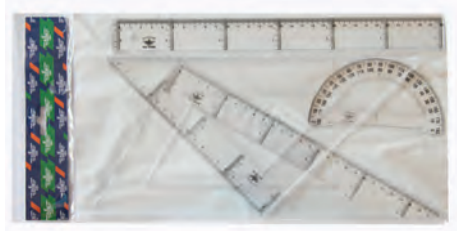

Equipo de dibujo Escolar Junior

Código	Ref.	Tamaño	U/Vta	U/Emb
18402011	200007	25 cm	1	80
18402000	200009	30 cm	1	80



Escalímetro Junior triangular escolar 30 cm

Código	Ref.	U/Vta	U/Emb
28601002	271137	20	200



Compás escolar con adaptador, tubo minas y protector de aguja, 5 colores

Código	Ref.	U/Vta	U/Emb
16301176	801521	1	240



Compás escolar con protector de aguja y minas surtido

Código	Ref.	U/Vta	U/Emb
16301247	802248	1	144



Compás Escolar pata articulada con adaptador y mina

Código	Ref.	U/Vta	U/Emb
16301165	802249	1	120



Compás escolar con protector aguja y mina colores surtidos

Código	Ref.	U/Vta	U/Emb
16301015	801520C	1	240



Compás bigotera gigante con alargadera

Código	Ref.	U/Vta	U/Emb
16301233	805300	1	80



Compás bigotera gigante con ajuste rápido, levas metálicas, colores surtidos

Código	Ref.	U/Vta	U/Emb
16301232	805505	1	60



Compás bigotera gigante con adaptador y tubo de minas colores surtidos

Código	Ref.	U/Vta	U/Emb
16301081	805305	1	120



Compás bigotera gigante con ajuste rápido y alargadera, colores surtidos

Código	Ref.	U/Vta	U/Emb
16301172	805500	1	80



Compás Escolar con alargadera y bigotera + complementos

Código	Ref.	U/Vta	U/Emb
16301166	802202	1	120



Compás Técnico Telescópico con adaptador y mina

Código	Ref.	U/Vta	U/Emb
16301177	803301	1	120

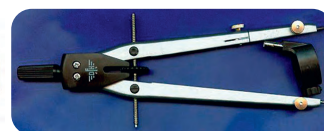

Compás Bigotera Gigante, Sencilla con adaptador

Código	Ref.	U/Vta	U/Emb
16301197	805516	1	240



Compás escolar pastel colores surtidos

Código	Ref.	U/Vta	U/Emb
16301080	801526	1	120



Porta Planos tubo extensible
Grande (70-120cm) / Pequeño (40-65cm)

Código	Ref.	Ref.	U/Vta	U/Emb
24318013	600031	Grande - 8 cm	1	44
24318014	600032	Gigante - 11 cm	1	24
24318018	600030 NEGRO	Pequeño - 6 cm	1	170



Adaptador lápiz caucho ambidiestro
Bote de 50

Código	Ref.	U/Vta	U/Emb
13601011	426834	1	50



Afilalápiz metálico

Código	Ref.	Cuña	U/Vta	U/Emb
13701069	604101	1	36	1440
13701072	604103	2	36	1440



Afilalápiz rectangular de madera 1 uso
Caja de 24

Código	Ref.	U/Vta	U/Emb
13701283	425101	1	1



Afilalápiz rectangular de madera 2 usos
Caja de 16

Código	Ref.	U/Vta	U/Emb
13701284	425201	1	1



Afilalápiz cilíndrico de madera con depósito
Caja de 20

Código	Ref.	Artículo	U/Vta	U/Emb
13701285	425102	1 uso	1	1
13701286	425202	2 usos	1	1



Afilalápiz Magnesio 1 uso
bote de cristal

Código	Ref.	U/Vta	U/Emb
13701200	422202	15	15



Afilalápiz especial zurdos fuelle flexible
2 usos con tapa. Caja de 6

Código	Ref.	U/Vta	U/Emb
13701811	426202	1	30



Afilalápiz plástico 1 uso con depósito.
Colores flúor. Caja 50

Código	Ref.	U/Vta	U/Emb
13701160	421204	1	50



Afilalápiz plástico 2 usos con depósito,
Colores flúor. Caja de 20

Código	Ref.	U/Vta	U/Emb
13701161	423206	1	20



Afilalápiz cubo 3 usos
Caja de 16

Código	Ref.	U/Vta	U/Emb
13701201	424207	1	1



Afilalápiz AS2 especial madera
2 usos

Código	Ref.	U/Vta	U/Emb
13701810	424206	1	58



Afilalápiz Fuelle Flexible 2 usos
con tapa. Caja de 6

Código	Ref.	U/Vta	U/Emb
13701809	424202	1	30



Afilalápiz Pod K1 1 uso
Caja de 12

Código	Ref.	U/Vta	U/Emb
13701807	421202	1	408



Afilalápiz Pod K2 2 usos
Caja de 12

Código	Ref.	U/Vta	U/Emb
13701808	423202	1	408



Tableros de Corcho - Marco de Pino

Código	Ref.	Artículo	U/Vta	U/Emb
23801254	607-1	30 x 40 cm	1	20
23801246	607-2	40 x 60 cm	1	5
23801247	607-3	60 x 90 cm	1	5
23801367	607-4	60 x 120 cm	1	5

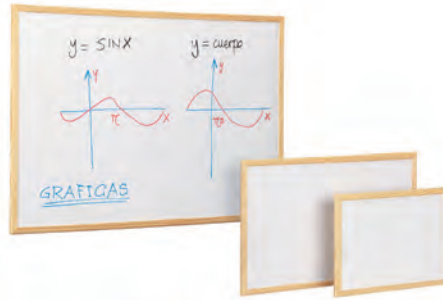

Pizarra Blanca - Marco de Pino

Código	Ref.	Artículo	U/Vta	U/Emb
23801463	502-1	30 x 40 cm	1	20
23801248	502-2	40 x 60 cm	1	10
23801249	502-3	60 x 90 cm	1	5



Pizarra Verde - Marco de Pino

Código	Ref.	Artículo	U/Vta	U/Emb
23801449	503-1	30 x 40 cm	1	20
23801250	503-2	40 x 60 cm	1	10
23801251	503-3	60 x 90 cm	1	5



Borrador y recambio para pizarra blancas

Código	Ref.	Artículo	U/Vta	U/Emb
15101053	15M	No imantado	1	50
15101012	15MG	Imantado	1	50
15101027	15RC	Recambio	1	50



Borrador de fieltro grande

Código	Ref.	U/Vta	U/Emb
15101013	15	1	50



Tijeras ergonómicas

Código	Ref.	Artículo	U/Vta	U/Emb
27601255	T1600	16 cm	1	10
27601113	T2100	21 cm	1	10
27601144	T2500	25 cm	1	10



Tijeras escolares 13cm Colores surtidos

Código	Ref.	Artículo	U/Vta	U/Emb
27601183	TE13	Diestros	1	400
27601184	TE13Z	Zurdos	1	400



Tijeras escolares 13cm Expositor 20 unidades

Código	Ref.	U/Vta	U/Emb
27601232	TE13E	1	10



Afilalápiz de aluminio rectangular

Código	Ref.	U/Vta	U/Emb
13701184	2002	24	1440



Afilalápiz de aluminio cuña

Código	Ref.	Artículo	U/Vta	U/Emb
13701183	2001	Un uso	24	1440
13701185	2003	Dos usos	12	720



Compás escolar Serie 226 con minas y adaptador

Código	Ref.	Artículo	U/Vta	U/Emb
16301245	226-04	Color verde	10	240
16301056	226EXP	Expositor de 20	1	12



Compás escolar minas y adaptador universal Serie Diseño

Código	Ref.	Color	U/Vta	U/Emb
16301237	613-03	Rojo	5	80
16301238	613-07	Azul	5	80
16301239	613-56	Pistacho	5	80
16301240	613EXP	Expositor de 6	1	16



Portaplanos de plástico 6,5cm de diámetro extensible (40-75cm)

Código	Ref.	Color	U/Vta	U/Emb
24318017	755-02	Negro	1	50
24318022	755-04	Verde	1	50
24318023	755-07	Azul	1	50
24318021	755-03	Rojo	1	50
24318024	755-08	Gris	1	50

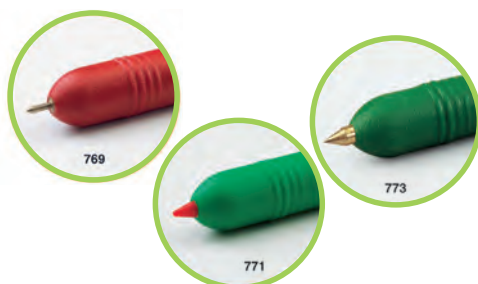

Punzones

Código	Ref.	Punta	U/Vta	U/Emb
25201007	769	Latón - Fina	25	1000
25201143	773	Latón - Gruesa	25	250
25201008	771	Plástico	25	1000



Almohadilla para picado 4 mm EVA 21x30 cm 20 unidades.

Código	Ref.	U/Vta	U/Emb
25205006	654	1	20



Goma Eva purpurina en hojas

Goma Eva en hojas de 40x60cm

Código	Ref.	Artículo	U/Vta	U/Emb
25201631	1655-01	Blanco	10	50
25201632	1655-02	Negro	10	50
25201633	1655-03	Rojo	10	50
25201634	1655-04	Verde Oscuro	10	50
25201635	1655-05	Amarillo	10	50
25201636	1655-07	Azul Oscuro	10	50
25201637	1655-08	Gris	10	50
25201638	1655-09	Marrón	10	50
25201639	1655-11	Naranja	10	50
25201640	1655-12	Fucsia	10	50
25201641	1655-21	Turquesa	10	50
25201642	1655-27	Violeta	10	50
25201643	1655-29	Rosa	10	50
25201644	1655-30	Piel	10	50
25201645	1655-34	Verde Claro	10	50
25201646	1655-47	Azul Claro	10	50
25201479	1655EXP	Exp. de 120	1	1

• 20x30cm

Código	Ref.	Artículo	U/Vta	U/Emb
25201647	1658-01	Blanco	3	432
25201648	1658-02	Negro	3	432
25201649	1658-03	Rojo	3	432
25201650	1658-04	Verde	3	432
25201651	1658-07	Azul	3	432
25201652	1658-11	Naranja	3	432
25201653	1658-12	Fucsia	3	432
25201654	1658-27	Violeta	3	432
25201655	1658-29	Rosa	3	432
25201656	1658-90	Oro	3	432
25201657	1658-91	Plata	3	432
25201513	1658-00	Bolsa de 5	3	144
25201480	1658-99	Exp. de 99	1	1

• 40x60cm

Código	Ref.	Artículo	U/Vta	U/Emb
25201658	1659-01	Blanco	3	108
25201659	1659-02	Negro	3	108
25201660	1659-03	Rojo	3	108
25201661	1659-04	Verde	3	108
25201662	1659-07	Azul	3	108
25201663	1659-11	Naranja	3	108
25201664	1659-12	Fucsia	3	108
25201665	1659-27	Violeta	3	108
25201666	1659-29	Rosa	3	108
25201667	1659-90	Oro	3	108
25201668	1659-91	Plata	3	108
25201512	1659-00	Bolsa de 5	3	108
25201481	1659-108	Exp. de 108	1	1



Bolsa estuche de dibujo Regla, escuadra, cartabón y semicírculo

Código	Ref.	U/Vta	U/Emb
18401028	804	20	80



Afilalápiz con depósito Expositor de 20 unidades

Código	Ref.	U/Vta	U/Emb
13701189	2101	1	20



Afilalápiz doble con depósito Expositor de 20 unidades

Código	Ref.	U/Vta	U/Emb
13701190	2102	1	20



My First Color'Peps Jumbo
Estuche de 12

Código	Ref.	Artículo	U/Vta	U/Emb
16001087	861311	Ceras	1	72
10201574	846020	Rotuladores	1	48



Ceras Plasticlean Color'Peps

Código	Ref.	Estuche	U/Vta	U/Emb
16001485	862011	12 uds	1	144
16001487	862013	24 uds	1	48



Rotulador Color'Peps Duo
Estuche 10 Uds

Código	Ref.	U/Vta	U/Emb
10201814	847010	1	144



Rotulador Fibra Color'Peps Jungle

Código	Ref.	Estuche	U/Vta	U/Emb
10201874	845902	12 uds	1	96
10201876	845904	24 uds	1	48



Lápices de color Color'Peps Jumbo

Código	Ref.	Estuche	U/Vta	U/Emb
12801414	834010	12 uds	1	108
12801513	834013	24 uds	12	48



Lápices de colores Color'Peps resina

Código	Ref.	Estuche	U/Vta	U/Emb
12802284	862723	12 uds*	12	144
12802150	862712	12 uds	12	180
12802151	862718	18 uds	12	108
12802152	862724	24 uds	12	72



Lápices de colores Color'Peps Strong

Código	Ref.	Artículo	U/Vta	U/Emb
12802285	862725	12 uds + 12 etiquetas	12	180
12802286	862726	24 uds + 24 etiquetas	12	72



Lápices de colores Color'Peps Pastel
Estuche de 12

Código	Ref.	U/Vta	U/Emb
12802279	832069	12	180



Lápices Color'Peps Star

Código	Ref.	Estuche	U/Vta	U/Emb
12801308	183212FC	12 uds	1	180
12801309	183218FC	18 uds	1	108
12801310	183224FC	24 uds	1	72
12801784	832017FC	36 uds	1	108
12802042	832048FC	48 uds	1	72
12802281	832072	72 uds	12	36



Lápices de colores Infinity

Código	Ref.	Estuche	U/Vta	U/Emb
12802485	861601	12 uds	1	72
12802486	861605	72 uds	1	20
12802487	861606	144 uds	1	12



Lápices de colores Infinity
Expositor de 24 estuches de 12 colores

Código	Ref.	U/Vta	U/Emb
12802488	993329	1	72

INCLUYE
TESTER

10x Rotuladores Jumbo
12x Ceras Jumbo Wax
1x Póster gigante



Maletín coloreado Early Age

Código	Ref.	U/Vta	U/Emb
11301172	897416	4	4



Ceras Gel Color'Peps Acuarelabes
Estuche de 10

Código	Ref.	U/Vta	U/Emb
16001081	836310	1	12



Rotulador Fibra Graph'Peps

Código	Ref.	Color	U/Vta	U/Emb
10201934	749150	Estuche de 10	1	60
10201935	749151	Estuche de 20	1	30



Marcador Fluo Mini Friends
Expositor de 48

Código	Ref.	U/Vta	U/Emb
10203632	743638	1	5



Marcador Fluo Peps pastel con glitter
Expositor de 12

Código	Ref.	U/Vta	U/Emb
10203630	742038	1	12



Marcador flúor Fluo Peps Classic
Expositor de 28

Código	Ref.	U/Vta	U/Emb
10202593	742537	1	6



Marcador flúor Sleeve distintos efectos
Pack de 12

Código	Ref.	U/Vta	U/Emb
10204869	740901	8	80



Marcador flúor Fluo Duo Pastel
Blister de 3

Código	Ref.	U/Vta	U/Emb
10203980	734128	12	180



Portatodo Pouch sobre de tela
personalizable con contenido
(12 rotuladores y 12 lápices de colores)

Código	Ref.	U/Vta	U/Emb
11302101	984729	1	96



6x negro
4x verde
4x violeta
2x verde trendy
2x rosa trendy
1x azul efecto lana
1x rosa efecto decorado
2x azul pattern
2x rosa pattern



Portatodo Deco reversible XXL
Expositor de 24

Código	Ref.	U/Vta	U/Emb
11302100	993423	1	1



Afilalápiz Vivo pastel 1 uso
Bote de 75 surtidos

Código	Ref.	U/Vta	U/Emb
13701208	063011	1	12



Afilalápiz Vivo 2 orificios
Bote de 30 surtidos

Código	Ref.	U/Vta	U/Emb
13701206	062511	1	12



Afilalápiz Color'Peps 2 usos
Expositor de 24

Código	Ref.	U/Vta	U/Emb
13701803	043111	1	12



Afilalápiz I-Gloo Eject 1 uso con depósito
Expositor de 30

Código	Ref.	U/Vta	U/Emb
13701037	032711	1	36



Afilaborra Connect Tacto Soft 2 usos
Expositor de 20

Código	Ref.	U/Vta	U/Emb
13701174	049221	1	12



Afilalápiz I-Gloo 2 usos con depósito
Expositor de 30

Código	Ref.	U/Vta	U/Emb
13701081	534756	1	18



Afilalápiz Croc-Croc Signal 1 uso
Expositor de 24

Código	Ref.	U/Vta	U/Emb
13701172	017711	1	12



Afilalápiz Croc-Croc Easy con depósito 1 uso
Expositor de 24

Código	Ref.	U/Vta	U/Emb
13701221	018113	1	12



Afilalápiz Shaker Fancy con depósito 1 uso
Expositor de 25

Código	Ref.	U/Vta	U/Emb
13701224	034014	1	30



Afilalápiz Croc-Croc 2 usos
Expositor de 18

Código	Ref.	U/Vta	U/Emb
13701096	501700	1	12



Afilalápiz Croc-Croc Innovation 1 uso
Expositor de 20

Código	Ref.	U/Vta	U/Emb
13702018	17611	1	12



Afilalápiz Croc Croc Hippo
Expositor de 20

Código	Ref.	U/Vta	U/Emb
13701282	016611	1	12



Afilalápiz Croc-Croc Twist 2 usos
Expositor de 12

Código	Ref.	U/Vta	U/Emb
13701248	018411	18	1



Afilalápiz metálico 1 Uso Satellite
Expositor de 32

Código	Ref.	U/Vta	U/Emb
13701048	534019	1	24



Afilalápiz Smiling Planet 1 uso
Colores surtidos

Código	Ref.	U/Vta	U/Emb
13701276	063021FM	75	3600



Afilalápiz Smiling Planet con depósito

Código	Ref.	Artículo	Expositor	U/Vta	U/Emb
13701278	071421FM	1 uso	28 uds	1	16
13701280	071521FM	2 usos	25 uds	1	10



Lápiz de Grafito Black Peps - Hb

Código	Ref.	U/Vta	U/Emb
12801577	850021FC	12	1728

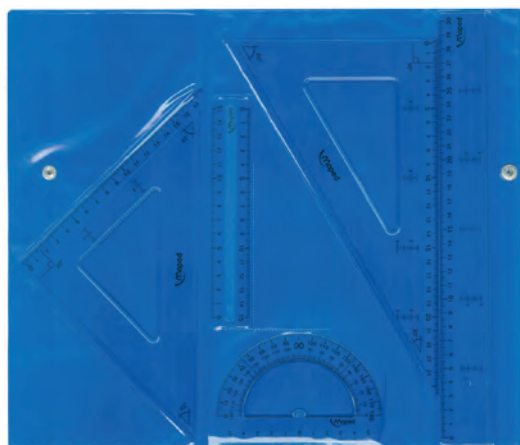

Equipo de dibujo Essentials 242

Código	Ref.	U/Vta	U/Emb
18401043	897112	1	80



Kit de reglas (4 piezas + 1 de regalo)

Código	Ref.	U/Vta	U/Emb
25501390	227835	1	50



Regla Twist&Flex irrompible

Código	Ref.	Cm	U/Vta	U/Emb
25501386	279110	15	1	200
25501370	027900	30	1	200



Taladro 2 punzones Essentials Metal E-4011
(10/12H) Negro

Código	Ref.	U/Vta	U/Emb
13101074	401111	1	64



Grapadora essentials metal pocket n°10 E-3526 (15h)

Código	Ref.	U/Vta	U/Emb
12901932	352611	1	200



Grapadora Ergologic Mini Standard (12H)

Código	Ref.	U/Vta	U/Emb
12901276	352111	1	240



Taladro 1 punzón Punchito (5H)
Expositor de 18 Surtido

Código	Ref.	U/Vta	U/Emb
13101073	533100	1	18



Compás Focus mina 2mm
Caja de 3 piezas

Código	Ref.	U/Vta	U/Emb
16301174	197512	1	180



Compás Stop System con adaptador

Código	Ref.	U/Vta	U/Emb
16301149	196100	1	120



Compás Technic Compact

Código	Ref.	U/Vta	U/Emb
16301116	538700	1	120



Compás Precision con adaptador universal

Código	Ref.	U/Vta	U/Emb
16301150	291010	1	80



Compás Tecníc apertura rápida
Con alargadera

Código	Ref.	U/Vta	U/Emb
16301061	178101	1	60



Compás Precision System Fancy surtido
Con minas y adaptador

Código	Ref.	U/Vta	U/Emb
16301072	291013	10	80



Compás surtido
Expositor de 40

Código	Ref.	U/Vta	U/Emb
16301017	897013	1	1



Tijeras Escolares Kidicut 12cm
Fibra de vidrio
Expositor de 20

Código	Ref.	U/Vta	U/Emb
27601093	137702	1	12



Tijeras Zenoa Fit Soft 13cm asimétrica
Expositor de 24

Código	Ref.	U/Vta	U/Emb
27601270	670112	1	288



Tijeras escolares Essential 13cm

Código	Ref.	Artículo	Expositor	U/Vta	U/Emb
27601118	464212	Diestros	24 uds	1	360
27601028	464312	Zurdos	10 uds	1	30



Tijeras Sensoft 3D 13cm

Código	Ref.	Artículo	Expositor	U/Vta	U/Emb
27601100	169300	Diestros	24 uds	1	6
27601106	693501	Zurdos	10 uds	1	24

TÉCNICAS ESCOLARES BASIK®



Bloc de dibujo con espiral microperforado A4+ liso 130g 20 hojas

Código	Ref.	U/Vta	U/Emb
10003021	C200408062	10	10



Bloc de dibujo microperforado Premium con espiral, liso 150g 20 hojas

*Incluye ceras Giotto DE REGALO.

Código	Ref.	Formato	U/Vta	U/Emb
10003058	C200400695/C650106000*	A4+	10	10
10003018	C200400694	A3+	10	10



Bloc de dibujo A4+ con espiral microperforado 130g 20 hojas

Código	Ref.	Rayado	U/Vta	U/Emb
10003616	C200409580	Taladro	10	10
10003040	C200408061	Recuadro	10	10
10003003	C200408063	Recuadro y 2 taladros	10	10



Láminas Minipack 130g 10 hojas

Código	Ref.	Tamaño	Rayado	U/Vta	U/Emb
10801024	C200406331	A4	Liso	20	20
10801186	C200406345	A4+	Liso	20	20
10801074	C200403159	A3	Liso	25	25
10801033	C200400797	A3+	Liso	25	25
10801030	C200406346	A4+	Recuadro	20	20
10801034	C200400798	A3+	Recuadro	25	25



Láminas de dibujo 130g

Código	Ref.	Formato	Rayado	U/Vta	U/Emb
10801005	C200401405	A4	Liso	250	250
10801003	C200400737	A4+	Liso	250	250
10801007	C200402766	A3	Liso	250	250
10801002	C200400734	A3+	Liso	250	250
10801001	C200400738	A4+	Recuadro	250	250
10801000	C200400735	A3+	Recuadro	250	250
10801018	C200401576	A4	Cajetín	250	250

Papel Milimetrado



Bloc encolado 100g 50 hojas

Código	Ref.	Formato	U/Vta	U/Emb
10011001	C200402861	A4	1	10
10011005	C200402863	A3	1	10

Mini pack 100g 12 hojas

Código	Ref.	Formato	U/Vta	U/Emb
10801066	C200406323	A4	25	25

Acuarela y témpera



Bloc de dibujo con espiral 370g 10 hojas

*Incluye acuarelas Giotto DE REGALO.

Código	Ref.	Formato	U/Vta	U/Emb
10003016	C200400698/C32500K012*	A4+	10	10
10003041	C200400697	A3+	10	10

Láminas Mini Pack 370g 6 hojas

Código	Ref.	Formato	U/Vta	U/Emb
10801187	C200006416	A4	20	20
10801042	C200406347	A4+	1	20
10801064	C200402393	A3	1	25

Papel Vegetal



Bloc encolado 95g 50 hojas

Código	Ref.	Formato	U/Vta	U/Emb
10011011	C200400714	A4+	10	10
10011010	C200400713	A3+	10	10

Mini Pack 95g 12 hojas

Código	Ref.	Formato	U/Vta	U/Emb
10801065	C200407621	A4	20	20
10801086	C200400787	A3	20	20

Láminas de papel vegetal 95g

Código	Ref.	Formato	U/Vta	U/Emb
10801004	C200406219	A4	250	250
10801006	C200406244	A3	250	250

Dibujo Lineal Basic



Mini Pack 160g 10 hojas

Código	Ref.	Formato	U/Vta	U/Emb
10801067	C200409784	A4	20	20
10801189	C200408991	A3	25	25

Láminas de dibujo 160g

Código	Ref.	Formato	U/Vta	U/Emb
10801009	C200401404	A4	250	250
10801037	C200402767	A3	250	250



20x C200409784
40x C200406331
20x C200406347
40x C200407621
25x C200406323
20x C200406282
25x C200403159
10x C200408062
10x C200408061
25x C200402393



Bloc de dibujo XL espiral

Código	Ref.	Tamaño	Modelo	Gramos	Hojas	U/Vta	U/Emb
10002955	C31200L015	A5	Mix Media	300	68	5	5
10002956	C31200L016	A4	Mix Media	300	68	5	5
10003572	C200807215	A4	Mix Media	300	30	5	5
10003573	C200807216	A3	Mix Media	300	30	5	5
10001455	C400039141	A4	Kraft	90	60	5	5
10001456	C400039142	A3	Kraft	90	60	5	5
10001451	C400039088	A4	Dessin	160	50	1	5
10001452	C400039089	A3	Dessin	160	50	5	5
10003570	C200777128	A4	Recycle	160	50	5	5
10003571	C200777129	A3	Recycle	160	50	5	5
10001432	C400039170	A4	Aquarelle	300	30	1	5
10001450	C400039171	A3	Aquarelle	300	30	5	5
10001459	C31078A021	A4	Bristol	180	50	5	5
10001460	C31078A022	A3	Bristol	180	50	5	5
10001457	C400039086	A4	Black	150	40	5	5
10001458	C400039087	A3	Black	150	40	5	5
10001479	C200787500	A4	White	90	120	1	5
10001480	C200787501	A3	White	90	120	1	5

**Lámina dibujo Mini-Pack Basik
Expositor surtido de 235**

Código	Ref.	U/Vta	U/Emb
10801206	C400110574/70/71	1	1

**Bloc de dibujo XL
Expositor surtido de 100**

Código	Ref.	U/Vta	U/Emb
18901344	C409200024	1	1



Bloc de dibujo Graduate encolado

Código	Ref.	Tamaño	Modelo	Gramos	Hojas	U/Vta	U/Emb
10003148	C400110365	A4	Dibujo	160g	30h	5	5
10002969	C400110362	A4	Croquis	96g	40h	5	5
10002970	C400110363	A3	Croquis	96g	40h	5	5
10002971	C400110368	A4	Mix media	220g	30h	5	5
10002972	C400110369	A3	Mix media	220g	30h	5	5
10002973	C400110371	A4	Mix media	220g	30h	5	5
10002974	C400110372	A3	Mix media	220g	30h	5	5
10002989	C400110374	A4	Acuarela	250g	20h	5	5
10002990	C400110375	A3	Acuarela	250g	20h	5	5

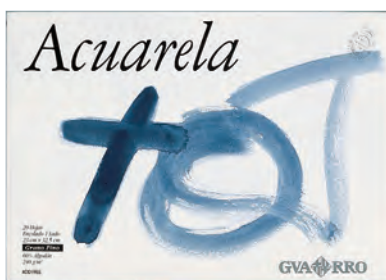

Bloc de dibujo acuarela grano grueso 240g 20 hojas

Código	Ref.	Formato	U/Vta	U/Emb
10003008	C200400721	A4+	1	10
10003009	C200400720	A3+	1	5



**Bloc de dibujo Esbozo Estudio
espiral microperforado 90g 100 hojas**

Código	Ref.	Tamaño	U/Vta	U/Emb
10003001	C200400254	A4	5	5
10003032	C200407690	A3	5	5

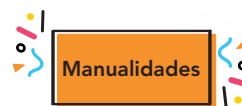

**Rollo papel Pinocho
0,5x2,5m 40g**

Color	Código	Ref.	U/Vta	U/Emb
Blanco	10901030	C200001400	10	10
Crema	10901225	C200001480	10	10
Amarillo Paja	10901226	C200001408	10	10
Amarillo Limón	10901057	C200001409	10	10
Capuchina	10901227	C200001410	10	10
Naranja Zinnia	10901050	C200001411	10	10
Rojo Vivo	10901054	C200001413	10	10
Coral	10902272	C400110406	10	10
Rosa Salmón	10901228	C200001403	10	10
Rosa Claro	10901049	C200001404	10	10
Rosa Pálido	10901459	C400055521	10	10
Rosa	10901052	C200001485	10	10
Frambuesa	10901229	C200001406	10	10
Lila	10901230	C200001424	10	10
Violeta	10901053	C200001425	10	10
Azul Cielo	10901458	C400055520	10	10
Azul Turquesa	10901044	C200001420	10	10
Azul Exótico	10901045	C200001422	10	10
Ultramar	10901231	C200001423	10	10
Azul mar del sur	10902273	C400110407	10	10
Verde Primavera	10901160	C200001414	10	10
Verde Billar	10901002	C200001416	10	10
Verde Helecho	10901232	C200001417	10	10
Verde Menta	10902274	C400110408	10	10
Verde Pastel	10902275	C400110409	10	10
Verde Caqui	10902276	C400110410	10	10
Chocolote	10902277	C400110411	10	10
Marrón	10901046	C200001492	10	10
Gris	10901234	C200001428	10	10
Negro	10901051	C200001429	10	10
Oro metalizado	10902266	C400110414	10	10
Plata metalizado	10902267	C400110415	10	10
Cobre metalizado	10902268	C400110416	10	10
Exp. 60 vivos	10901135	C400110412	1	1
Exp. 60 pastel	10902264	C400110413	1	1



CARTULINA IRIS®

Cartulina 185g

Color	Código	Código	Código
	50x65 cms - Paq. 25	A3 - Paquete 50	A4 - Paquete 50
Blanco	10701038	10701173	10701104
Crema	10701003	10701222	10701105
Amarillo Limón	10701017	10701202	10701101
Amarillo Canario	10701055	10701203	10701100
Gualda	10701013	10701204	10701106
Cáscara de huevo	10701401	10701697	10701499
Mandarina	10701271	10701272	10701273
Naranja	10701009	10701205	10701108
Tomate	10701198	10701206	10701195
Rojo	10701001	10701207	10701110
Granate	10701199	10701208	10701194
Coral	10701402	10701698	10701492
Fucsia	10701028	10701210	10701160
Rosa Chicle	10701405	10701701	10701493
Rosa	10701019	10701209	10701111
Lila	10701011	10701211	10701161
Malva	10701404	10701700	10701494
Violeta	10701056	10701212	10701162
Azul Cielo	10701012	10701213	10701102
Azul Caribe	10701400	10701696	10701495
Azul Turquesa	10701029	10701214	10701163
Azul Maldivas	10701200	10701215	10701193
Azul Mar	10701005	10701216	10701103
Azul Ultramar	10701010	10701217	10701164
Verde Manzana	10701018	10701218	10701113
Menta	10701406	10701702	10701496
Verde Kiwi	10701403	10701699	10701498
Verde Billar	10701015	10701219	10701112
Verde Abeto	10701030	10701220	10701165
Verde Amazonas	10701058	10701221	10701166
Verde Safari	10701407	10701703	10701497
Cuero	10701020	10701223	10701167
Chocolate	10701007	10701224	10701107
Gris Perla	10701008	10701225	10701170
Gris Plomo	10701042	10701226	10701171
Negro	10701002	10701227	10701109

Mueble de cartulina - Expositores

Código	Ref.	Artículo	U/Vta	U/Emb
10701501	C400109731	Expositor vacío 36 estantes A4	1	1
10701500	C400109732-9733-67	Contenido 3.600ud A4 185g 36 colores	1	1
10701705	C32000M000	Expositor vacío 42 estantes A3	1	1
10701704	C200040835/36/37/K00	Contenido 2.100ud A3 185g 42 colores	1	1
10701409	C400080321	Expositor vacío 42 estantes 50x65	1	1
10701408	C200040830-31-32-41	Contenido 1.150ud 50x65cm 185g 42 colores	1	1



**Expositor 3x200 cartulinas 50x65 cms
185 g - 23 colores**

Código	Ref.	Artículo	U/Vta	U/Emb
10701412	C400080320	SopORTE vacío	1	1
10701419	C200004696/97/80142	Contenido	1	1



**Cartulina Mini A4+ 185g
Pack de 10**

Código	Ref.	U/Vta	U/Emb
10701245	C200406282	20	20



Papel Color iris A4 80 g - 100h

Color	Código	Ref.	U/Vta	U/Emb
Ahuesado	12701070	C400032478	1	5
Amarillo Limón	12701071	C200407923	1	5
Azul Caribe	12701072	C400032523	1	5
Azul Pastel	12701074	C400032521	1	5
Azul Turquesa	12701075	C200401746	1	5
Gris Perla	12701078	C200401760	1	5
Gualda	12701079	C200401233	1	5
Lavanda	12701084	C400032479	1	5
Naranja	12701081	C400032522	1	5
Rojo Tomate	12701082	C400032525	1	5
Rosa intenso	12701083	C400032524	1	5
Salmón	12701084	C400032520	1	5
Verde Billar	12701085	C400032526	1	5
Verde Manzana	12701086	C200401755	1	5
Verde Pastel	12701087	C200401754	1	5



1



2



3



4



5

Flautas Hohner

	Código	Ref.	Descripción	U/Vta	U/Emb
1	19701006	9501	1- Flautas madera 2 piezas	1	1
2	19701011	9555	2- Flautas madera 2 piezas	1	50
3	19701004	9516	3- Flautas plástico 2 piezas	1	500
4	19701003	9508	4- Flautas plástico lisa	1	600
5	19701013	1680025	5- Escobilla limpiadora para flautas	24	288

Auténtico papel

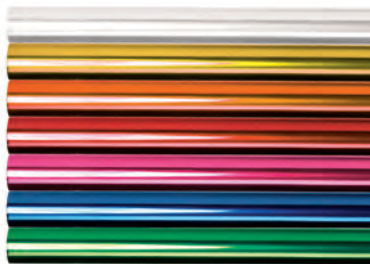

Papel Celofán 25 Pliegos 50x65 cm

Código	Ref.	Color	U/Vta	U/Emb
10901074	12506	Amarillo	1	12
10901072	12502	Azul	1	12
10901073	12508	Incoloro	1	12
10901071	12507	Naranja	1	12
10901069	12501	Rojo	1	12
10901070	12503	Verde	1	12

Papel Celofán 0,7x10 m

Código	Ref.	Color	U/Vta	U/Emb
10901177	06405	Amarillo	1	12
10901178	06402	Azul	1	12
10901089	06407	Incoloro	1	12
10901179	06406	Naranja	1	12
10901180	06401	Rojo	1	12
10901182	06403	Verde	1	12



**Papel Charol (papel estucado brillante)
25 Pliegos 50x65cm**

Código	Ref.	Color	U/Vta	U/Emb
10901079	12911	Amarillo	1	12
10901075	12906	Azul cobalto	1	12
10901097	12905	Azul fuerte	1	12
10901076	12904	Azul pálido	1	12
10901082	12901	Blanco	1	12
10901078	12902	Marrón	1	12
10901077	12912	Naranja	1	12
10901084	12908	Negro	1	12
10901081	12903	Rojo	1	12
10901013	12909	Rosa pálido	1	12
10901080	12907	Verde	1	12
10901083	12910	Rosa fuerte	1	12
10901902	12935	Verde pálido	1	12
10901903	12937	Violeta	1	12



**Papel Aluminio 0,50 x 2 m
Expositor surtido de 50**

Código	Ref.	U/Vta	U/Emb
10907100	05354	1	1



**Papel Seda FSC 50x75cm 18g/m²
Bolsa de 26 hojas**

**Sin migración
de color**

Código	Ref.	Color	U/Vta	U/Emb
10901043	S0718103	Amarillo	1	20
10901200	S0718111	Azul cielo	1	20
10901019	S0718113	Azul fuerte	1	20
10901064	S0718112	Azul pálido	1	20
10901016	S0718101	Blanco	1	20
10901017	S0718117	Marrón	1	20
10901061	S0718104	Naranja	1	20
10901060	S0718119	Negro	1	20
10901236	11166	Oro	1	20
10901237	11167	Plata	1	20
10901104	S0718105	Rojo	1	20
10901161	S0718107	Rosa fuerte	1	20
10901199	S0718116	Verde fuerte	1	20
10901095	S0718115	Verde medio	1	20
10901058	S0718114	Verde pálido	1	20
10901065	S0718109	Violeta	1	20
10901901	S0718106	Magenta	1	20



Papel Crepe - FSC (Pinocho) 40g 78% 0,5x2,5m

Código	Ref.	Color	U/Vta	U/Emb
10902398	S1545001	Blanco	10	10
10902399	S1545002	Amarillo	10	10
10902400	S1545003	Amarillo canario	10	10
10902401	S1545004	Naranja	10	10
10902402	S1545005	Rojo	10	10
10902403	S1545006	Granate	10	10
10902404	S1545007	Magenta	10	10
10902405	S1545008	Rosa	10	10
10902406	S1545009	Fucsia	10	10
10902407	S1545010	Violeta	10	10
10902408	S1545011	Morado	10	10
10902409	S1545012	Lila	10	10
10902410	S1545013	Turquesa	10	10
10902411	S1545014	Azul fuerte	10	10
10902412	S1545015	Azul marino	10	10
10902413	S1545016	Lima	10	10
10902414	S1545017	Verde medio	10	10
10902415	S1545018	Verde fuerte	10	10
10902416	S1545019	Marrón fuerte	10	10
10902417	S1545020	Naranja fuerte	10	10
10902418	S1545021	Verde musgo	10	10
10902419	S1545022	Marrón	10	10
10902420	S1545023	Coral rosa	10	10
10902421	S1545024	Negro	10	10



**Papel Crepe - FSC (Pinocho) Aluminio
0,5 x 1,5m**

Código	Ref.	Color	U/Vta	U/Emb
10902393	S1505001	Rojo	10	10
10902394	S1505002	Azul fuerte	10	10
10902395	S1505003	Verde fuerte	10	10
10902396	S1505004	Plata	10	10
10902397	S1505005	Oro	10	10



**Papel cartón Ondulado (tintado en masa) 50x65 328g
Paquete de 5**

Código	Ref.	Color	U/Vta	U/Emb
10901171	05918	Amarillo	1	5
10901195	05824	Azul fuerte	1	5
10901172	05917	Azul	1	5
10901173	05914	Blanco	1	5
10901174	05913	Negro	1	5
10901175	05916	Rojo	1	5
10901194	05823	Verde fuerte	1	5
10901176	05919	Verde pálido	1	5
10901766	05826	Rosa	1	5
10901767	05827	Fucsia	1	5
10901768	05828	Morado	1	5
10901769	05829	Marrón fuerte	1	5
10901770	05920	Violeta	1	5
88004006	05915	Naranja	1	5
10904004	05830	Expositor de 100	1	1



Papel crepé (pinocho) 180g (260%) 0,5x2,5 m

Código	Ref.	Color	U/Vta	U/Emb
10902447	S1585001	Blanco	5	5
10902448	S1585002	Amarillo	5	5
10902449	S1585003	Amarillo canario	5	5
10902450	S1585004	Naranja	5	5
10902451	S1585005	Rojo	5	5
10902452	S1585006	Granate	5	5
10902453	S1585007	Magenta	5	5
10902454	S1585008	Rosa	5	5
10902455	S1585009	Fucsia	5	5
10902456	S1585010	Violeta	5	5
10902457	S1585011	Morado	5	5
10902458	S1585012	Azul cielo	5	5
10902459	S1585013	Azul marino	5	5
10902460	S1585014	Turquesa	5	5
10902461	S1585015	Azul fuerte	5	5
10902462	S1585016	Rosa fuerte	5	5
10902463	S1585017	Verde medio	5	5
10902464	S1585018	Verde fuerte	5	5
10902465	S1585019	Marrón fuerte	5	5
10902466	S1585020	Naranja fuerte	5	5
10902467	S1585021	Verde musgo	5	5
10902468	S1585022	Marrón	5	5
10902469	S1585023	Coral rosa	5	5
10902470	S1585024	Negro	5	5



**Papel Crepe - FSC (Pinocho) 40g 0,5x2,5m
Expositor surtido de 120 (5 uds x 24 colores)**

Código	Ref.	U/Vta	U/Emb
10902422	S1545050	1	1



Papel de embalar kraft rollo Nefertiti 1 x 3m

Código	Ref.	Color	U/Vta	U/Emb
10901445	10724	Azul azurita	1	30
10901443	10727	Azul turquesa	1	30
10901463	10725	Fucsia	1	30
10901464	10729	Verde malaquita	1	30
10901442	10728	Verde musgo	1	30
10901257	10726	Violeta	1	30
10901756	10661	Naranja fuerte	1	30
10901761	10676	Marrón fuerte	1	30

Disponible en más medidas. Consúltanos!

Papel de embalar kraft en bobina 1m - 10kg

Código	Ref.	Color	U/Vta	U/Emb
10901567	10903	Amarillo	1	1
10902899	10941	Naranja intenso	1	1
10901566	10904	Rojo	1	1
10902900	10942	Cherry	1	1
10901742	10913	Fucsia	1	1
10902901	10943	Rosa	1	1
10901743	10914	Violeta	1	1
10901744	10915	Azul turquesa	1	1
10901568	10905	Azul	1	1
10901569	10906	Verde	1	1
10901745	10916	Verde musgo	1	1
10902902	10944	Marrón fuerte	1	1
10901461	10907	Negro	1	1
10902152	10955	Oro	1	1
10902153	10956	Plata	1	1

Papel de embalar kraft en bobina

Código	Ref.	Tamaño	Color	U/Vta	U/Emb
10901571	10901	1m - 10kg	Marrón	1	1
10901570	10902	1m - 10kg	Blanco	1	1
10901738	10908	1m - 25kg	Marrón	1	1
10901737	10909	1m - 25kg	Blanco	1	1
10901740	10910	1m - 50kg	Marrón	1	1
10901739	10911	1m - 50kg	Blanco	1	1



Papel de embalar Kraft verjurado rollo

Código	Ref.	Tamaño	Color	Gama	U/Vta	U/Emb
10901090	10610	1x5	Amarillo	Fusión	1	30
10901118	10604	1x5	Azul	Fusión	1	30
10901093	10637	1x5	Rojo	Fusión	1	30
10901007	10606	1x5	Verde	Fusión	1	30
10901101	10608	1x5	Negro	Fusión	1	30
10901747	10667	1x5	Rosa	Fusión	1	30
10901752	10672	1x5	Verde fuerte	Fusión	1	30
10901034	10617	1x10	Amarillo	Fusión	1	24
10901008	10614	1x10	Azul	Fusión	1	24
10901427	10616	1x10	Negro	Fusión	1	24
10901006	10613	1x10	Rojo	Fusión	1	24
10901032	10615	1x10	Verde	Fusión	1	24
10901748	10668	1x10	Rosa	Fusión	1	24
10901753	10673	1x10	Verde fuerte	Fusión	1	24
10901274	10623	1x25	Amarillo	Fusión	1	10
10901271	10620	1x25	Azul	Fusión	1	10
10901273	10622	1x25	Negro	Fusión	1	10
10901270	10619	1x25	Rojo	Fusión	1	10
10901272	10621	1x25	Verde	Fusión	1	10
10901749	10669	1x25	Rosa	Fusión	1	10
10901754	10674	1x25	Verde fuerte	Fusión	1	10
10901140	10656	1x50	Azul	Fusión	1	6
10901141	10655	1x50	Rojo	Fusión	1	6
10901215	10657	1x50	Verde	Fusión	1	6
10901750	10670	1x50	Rosa	Fusión	1	6
10901755	10675	1x50	Verde fuerte	Fusión	1	6
10901114	10630	1x3	Blanco	Natura	1	30
10901111	10625	1x3	Marrón	Natura	1	30
10901115	10632	1x5	Blanco	Natura	1	30
10901112	10627	1x5	Marrón	Natura	1	30
10901116	10634	1x10	Blanco	Natura	1	24
10901113	10628	1x10	Marrón	Natura	1	24
10901422	10636	1x25	Blanco	Natura	1	10
10901103	10629	1x25	Marrón	Natura	1	10
10901166	10639	1x50	Blanco	Natura	1	6
10901105	10638	1x50	Marrón	Natura	1	6



Papel de embalar Gran formato XL Kraft verjurado 1x3m Expositor de 100

Código	Ref.	U/Vta	U/Emb
10902567	S0310004	1	1



Papel de embalar Kraft verjurado Rollo Natura 1x3m Expositor de 24 (18x marrón/6x blanco)

Código	Ref.	U/Vta	U/Emb
10904047	11264	1	1



Terciopelelo adhesivo 0,45x1m Exp.12 (1xcolor)

Código	Ref.	U/Vta	U/Emb
11801269	06728	1	1

Terciopelelo adhesivo rollo 0,45 x 1 m

Código	Ref.	Color	U/Vta	U/Emb
11801165	06719	Amarillo	1	4
11801169	06723	Naranja	1	4
11801190	06708	Rojo	1	4
11801202	06711	Granate	1	4
11801168	06722	Fucsia	1	4
11801166	06720	Lila	1	4
11801167	06721	Turquesa	1	4
11801201	06710	Azul	1	4
11801182	06709	Verde	1	4
88003742	06707	Negro	1	4
11801030	06726	Chocolate	1	4
11801032	06727	Blanco	1	4

Terciopelelo adhesivo rollo 0,45 x 10 m

Código	Ref.	Color	U/Vta	U/Emb
11805001	06714	Amarillo	1	1
11801025	06704	Azul	1	1
11805003	06717	Fucsia	1	1
11805004	06715	Lila	1	1
11805002	06718	Naranja	1	1
11805005	06716	Turquesa	1	1
11801007	06706	Whisky	1	1
11801211	06724	Chocolate	1	1
11801212	06725	Blanco	1	1
11801037	06702	Rojo	1	1
11801046	06705	Granate	1	1
11801072	06703	Verde	1	1
11801213	06701	Negro	1	1



Papel de embalar Fusion Kraft verjurado 1x3m Expositor de 24 (3x8 colores)

Código	Ref.	U/Vta	U/Emb
10904046	S0310005	1	1



Papel de embalar Nefertiti Kraft verjurado 1x3m Expositor de 24 (3x8 colores)

Código	Ref.	U/Vta	U/Emb
10902748	S0310006	1	1

Con plantillas recortables



Film adhesivo polipropileno mate 100µ
Rollo de 0,5 x 3m

Código	Ref.	Color	U/Vta	U/Emb
11801049	12213	Amarillo	1	16
11801052	12211	Azul	1	16
11801126	12245	Azul Turquesa	1	16
11801125	12243	Naranja	1	16
11801053	12210	Rojo	1	16
11801051	12212	Verde	1	16
11801242	12256	Fucsia	1	16
11801188	12240	Lila	1	16
11801189	12241	Marrón	1	16
11801050	12214	Negro	1	16
11801103	12239	Oro	1	16
11801102	12238	Plata	1	16

Film adhesivo polipropileno mate 100µ Rollo de 0,5 x 20m

Código	Ref.	Color	U/Vta	U/Emb
88003772	12209	Amarillo	1	5
11801132	12244	Naranja	1	5
11801138	12205	Rojo	1	5
11801243	12257	Fucsia	1	5
11801139	12236	Morado	1	5
11801133	12246	Turquesa	1	5
11801183	12206	Azul	1	5
11801057	12207	Verde	1	5
11801184	12237	Marrón	1	5
11801056	06802	Blanco	1	5
88003771	12208	Negro	1	5
11801105	12235	Oro	1	5
11801104	12234	Plata	1	5

Film adhesivo polipropileno 0,5 x 3m
Expositor surtido de 24

Código	Ref.	U/Vta	U/Emb
11801155	12242	1	1



Cartulina colores Colore A4 185g
Paquete de 10

Código	Ref.	Artículo	U/Vta	U/Emb
10703012	S322A450	Col. intensos	1	20
10703011	S322A451	Col. pastel	1	20



Cartulina aluminio A4 225g
Paquete de 5 colores

Código	Ref.	U/Vta	U/Emb
10705007	20286	1	8

Blíster cartulina Flúor A4 250g
Paquete de 5 colores

Código	Ref.	U/Vta	U/Emb
10704001	15429	1	40

Cartulina Purpurina A4 330g
Paquete surtido de 5

Código	Ref.	Artículo	U/Vta	U/Emb
10701627	20309	Col. intensos	1	30
10701628	20315	Col. pastel	1	30



Forro ajustable Forralisto PVC transparente de 120µ

Código	Ref.	Artículo	U/Vta	U/Emb
11801311	02213	28 x 55cm*	1	25
11801312	02214	28,5 x 55cm*	1	25
11801313	02215	29 x 55cm*	1	25
11801314	02216	29,5 x 55cm*	1	25
11801315	02217	30 x 55cm*	1	25
11801263	02052	22 x 45cm	5	50
11801264	02053	28 x 55cm	5	50
11801265	02054	28,5 x 55cm	5	50
11801266	02055	29 x 55cm	5	50
11801267	02056	29,5 x 55cm	5	50
11801268	02057	30 x 55cm	5	50

*Blíster de 5



Forro ajustable Forralisto PP transparente de 80µ

Código	Ref.	Artículo	U/Vta	U/Emb
11801245	02207	28 x 55cm*	25	25
11801246	02208	28,5 x 55cm*	25	25
11801159	02209	29 x 55cm*	25	25
11801247	02210	29,5 x 55cm*	25	25
11801248	02211	30 x 55cm*	25	25
11801122	02010	28 x 50,5cm	5	100
11801251	01198	28,5 x 50,5cm	5	100
11801121	02011	29 x 50,5cm	5	100
11801218	01199	29,5 x 50,5cm	5	100
11801123	02012	30 x 50,5cm	5	100
11801262	02013	31 x 55cm	5	100

*Blíster de 5



Doblar y despegar,
despegado fácil!

Forro Adhesivo de PP en rollo sin pvc
Despegable durante 1 año

Código	Ref.	Medida	Artículo	U/Vta	U/Emb
11801108	01069	0,33 x 1,5m	50µ	25	25
11801109	01070	0,5 x 1,5m	50µ	25	25
11801328	12339	0,5 x 3m	80µ	1	6
11801146	01071	0,5 x 20m	80µ	1	6



Doblar y despegar,
despegado fácil!

Forro adhesivo 50µ PP despegado fácil en rollo sin PVC

Código	Ref.	Medida	Artículo	U/Vta	U/Emb
11801003	12801	0,33 x 1,5m	50µ	25	25
11801015	12803	0,5 x 1,5m	50µ	25	25
11801322	12815	0,5 x 3m	50µ	25	25
11801323	12876	0,45 x 2m	80µ	35	35
11801324	12877	0,45 x 3m	80µ	30	30
11801325	12873	0,45 x 5m	80µ	20	20
11801326	12878	0,45 x 10m	80µ	10	10
11801327	12866	0,45 x 20m	80µ	6	6
88003791	12805	0,5 x 3m	80µ	20	20
11801035	12802	0,5 x 20m	80µ	6	6
11801321	01122	0,5 x 3m	100µ	20	20
88003790	12804	0,5 x 15m	100µ	6	6
11801317	01123	0,5 x 20m	100µ	6	6



Cartulina Fabriano Colore 185g

Color	50x65cm - Paquete de 25					A3 - Paquete de 25					A4 - Paquete de 50					A4 - Paquete de 10				
	Código	Ref.	Uv	U/E		Código	Ref.	Uv	U/E		Código	Ref.	Uv	U/E		Código	Ref.	Uv	U/E	
Amarillo canario	10701297	S3215603	1	5		10702026	S321A303	1	4		10703001	S321A403	1	4		10701293	S322A403	1	20	
Amarillo intenso	10701124	S3215604	1	5		10701422	S321A304	1	4		10701428	S321A404	1	4		10701682	S322A404	1	20	
Arena	10701146	S3215623	1	5		10702025	S321A323	1	4		88003888	S321A423	1	4		10701323	S322A423	1	20	
Avana	10701151	S3215625	1	5		10702024	S321A325	1	4		10701242	S321A425	1	4		10701320	S322A425	1	20	
Azul cielo	10701131	S3215614	1	5		10702033	S321A314	1	4		10701120	S321A414	1	4		10701319	S322A414	1	20	
Azul cobalto	10701133	S3215616	1	5																
Azul marino	10701132	S3215617	1	5		10702035	S321A317	1	4		10703007	S321A417	1	4		10701327	S322A417	1	20	
Azul turquesa	10701150	S3215615	1	5		10702034	S321A315	1	4		10703006	S321A415	1	4		10701318	S322A415	1	20	
Banana	10701130	S3215602	1	5		10702027	S321A302	1	4		88003731	S321A402	1	4		10701324	S322A402	1	20	
Blanco	10701292	S3215601	1	5		10702041	S321A301	1	4		10701114	S321A401	1	4		10701291	S322A401	1	20	
Cereza	10701135	S3215608	1	5		10701425	S321A308	1	4		10701431	S321A408	1	4		10701505	S322A408	1	20	
Crema	10701136	S3215624	1	5																
Fucsia	10701322	S3215609	1	5		10701426	S321A309	1	4		10701427	S321A409	1	4		10701506	S322A409	1	20	
Gris antracita	10701138	S3215628	1	5																
Gris perla	10701139	S3215629	1	5		10702042	S321A329	1	4		10703010	S321A429	1	4		10701321	S322A429	1	20	
Lila	10701140	S3215611	1	5		10702031	S321A311	1	4		10703004	S321A411	1	4		10701325	S322A411	1	20	
Marrón	10701142	S3215627	1	5		10702040	S321A327	1	4		88003889	S321A427	1	4		10701331	S322A427	1	20	
Morado	10701420	S3215613	1	5		10701423	S321A313	1	4		10701429	S321A413	1	4		10701507	S322A413	1	20	
Naranja	10701143	S3215605	1	5																
Naranja intenso	10701144	S3215606	1	5		10702028	S321A306	1	4		10701117	S321A406	1	4		10701316	S322A406	1	20	
Negro	10701145	S3215630	1	5		10702043	S321A330	1	4		10701115	S321A430	1	4		10701296	S322A430	1	20	
Rojo	10701147	S3215607	1	5		10702029	S321A307	1	4		10703002	S321A407	1	4		10701294	S322A407	1	20	
Rosa	10701149	S3215610	1	5		10702030	S321A310	1	4		10703003	S321A410	1	4		10701326	S322A410	1	20	
Terracota	10701148	S3215626	1	5		10702039	S321A326	1	4		10701119	S321A426	1	4		10701330	S322A426	1	20	
Verde intenso	10701153	S3215621	1	5		10702038	S321A321	1	4		10703009	S321A421	1	4		10701329	S322A421	1	20	
Verde lima	10701141	S3215619	1	5		10702037	S321A319	1	4		88003732	S321A419	1	4		10701295	S322A419	1	20	
Verde malaquita	10701421	S3215620	1	5		10701424	S321A320	1	4		10701430	S321A420	1	4		10701508	S322A420	1	20	
Verde pálido	10701154	S3215618	1	5		10702036	S321A318	1	4		10703008	S321A418	1	4		10701328	S322A418	1	20	
Verde pino	10701155	S3215622	1	5																
Violeta	10701156	S3215612	1	5		10702032	S321A312	1	4		10703005	S321A412	1	4		10701317	S322A412	1	20	



Cartulina 50x65cm 185g
Caja expositora
+ contenido de 450

Código	Ref.	U/Vta	U/Emb
10701687	S3215650	1	1



Cartulina Fabriano LR 220g 50x70cm
(Con dos caras, diferencia de texturas
en las superficies. 1 cara rugosa)
Caja expositora de 400

Código	Ref.	U/Vta	U/Emb
10701410	06003	1	1

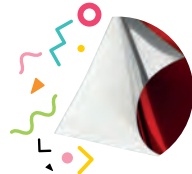

Cartulina Aluminio 50x65cm 225g
Paquete de 10

Código	Ref.	Color	U/Vta	U/Emb
10701016	20257	Azul	1	12
10701004	20261	Oro	1	12
10701006	20259	Plata	1	12
10701022	20256	Rojo	1	12
10701021	20258	Verde	1	12



Cartulina Purpurina 50x65 330g
Paquete de 5

Código	Ref.	Color	U/Vta	U/Emb
10701603	20290	Oro	1	24
10701604	20291	Plata	1	24
10701605	20292	Cobre	1	24
10701606	20293	Azul	1	24
10701607	20294	Verde	1	24
10701608	20295	Fucsia	1	24
10701609	20296	Rojo	1	24
10701610	20297	Blanco	1	24
10701611	20298	Verde claro	1	24
10701612	20299	Amarillo	1	24
10701613	20300	Azul claro	1	24
10701614	20301	Rosa	1	24

Cartulina Purpurina A4 330g
Paquete de 3

Código	Ref.	Color	U/Vta	U/Emb
10701615	20302	Oro	1	50
10701616	20303	Plata	1	50
10701617	20304	Cobre	1	50
10701618	20305	Azul	1	50
10701619	20306	Verde	1	50
10701620	20307	Fucsia	1	50
10701621	20308	Rojo	1	50
10701622	20310	Blanco	1	50
10701623	20311	Verde claro	1	50
10701624	20312	Amarillo	1	50
10701625	20313	Azul claro	1	50
10701626	20314	Rosa	1	50



Cartulina Fluorescente 50x65cm 250g
Paquete de 10

Código	Ref.	Color	U/Vta	U/Emb
10701023	15408	Amarillo	1	12
10701027	15410	Magenta	1	12
10701026	15409	Naranja	1	12
10701025	15406	Rojo	1	12
10701024	15407	Verde	1	12

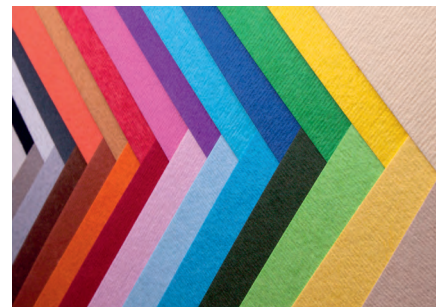

Cartulina Liso/Rugoso 50x70cm 220g. Paquete de 20
Alta resistencia, idónea para trabajos manuales.
Para impresión Inkjet y láser.



Expositor metálico + contenido cartulina Colore
A4 185g. 5000uds (200 x 25 colores)

Código	Ref.	U/Vta	U/Emb
10701684	14052	1	1

Expositor metálico + contenido cartulina Liso/Rugoso
A4 220g. 7500 uds (300x25 colores)

Código	Ref.	U/Vta	U/Emb
10701414	14034	1	1

Expositor metálico + contenido cartulina Colore
50x65cm 185g. 2250uds (75 x 30 colores)

Código	Ref.	U/Vta	U/Emb
10701683	14044	1	1

Expositor metálico + contenido cartulina Liso/Rugoso
50x70cm 220g. 2700 uds (100x27 colores)

Código	Ref.	U/Vta	U/Emb
10701389	14033	1	1

Código	Ref.	Color	U/Vta	U/Emb
10701189	F42450701	Panna	1	1
10701362	F42450717	Onice	1	1
10701363	F42450725	Cedro	1	1
10701364	F42450707	Amarillo (Giallo)	1	1
10701365	F42450726	Naranja (Aragosta)	1	1
10701366	F42450708	Naranja (Arancio)	1	1
10701367	F42450709	Rojos (Rosso)	1	1
10701368	F42450727	Cherry (Ciliegia)	1	1
10701369	F42450716	Rosa	1	1
10701370	F42450723	Fucsia	1	1
10701371	F42450704	Violeta (Viola)	1	1
10701372	F42450714	Azul oscuro (Bleu)	1	1
10701373	F42450713	Azul (Azzurro)	1	1
10701374	F42450720	Cielo	1	1
10701375	F42450718	Celeste	1	1
10701376	F42450710	Verde pisello	1	1
10701377	F42450711	Verde	1	1
10701378	F42450728	Verdone	1	1
10701379	F42450703	Avana	1	1
10701380	F42450719	Terra bruciata	1	1
10701381	F42450706	Marrón	1	1
10701382	F42450730	China	1	1
10701383	F42450729	Brina	1	1
10701384	F42450702	Perla	1	1
10701385	F42450722	Ferro	1	1
10701386	F42450715	Negro (Nero)	1	1
10701387	F42450700	Blanco (Bianco)	1	1

LOS MEJORES BLOCS DE MANUALIDADES DEL MERCADO

Los nuevos blocs son 100% papel sin plásticos. Se ha eliminado la bolsa protectora de plástico por el nuevo cierre de pestaña que mantiene protegido el producto de forma sostenible. Producto Made in Spain. Papeles certificados FSC.

*Surtido 42 hojas:
10 hojas cartulina
10 hojas papel charol
10 hojas papel seda
7 hojas papel celofán
5 hojas cartulina aluminio



Contenido
110x S0400001 papeles creativos
120x S0400002 cartulina color
10x S0400003 cartulina blanca
10x S0400004 cartulina negra
30x S0400005 papel seda
20x S0400006 papel celofán
50x S0400007 papel charol

Block manualidades
Expositor surtido de 350

Código	Ref.	U/Vta	U/Emb
10001696	14036	1	1





Expositor metálico surtido 130 ud
Blocs de dibujo 1264

Código	Ref.	U/Vta	U/Emb
10003049	14061	1	1



Blocs de dibujo Gama 1264



Expositor de sobremesa surtido 70 ud
Blocs de dibujo 1264

Código	Ref.	U/Vta	U/Emb
10003060	14062	1	1



Bloc de dibujo 1264 técnicas mixtas
grano natural, 90g

Código	Referencia	Artículo	Espiral	U/Vta	U/Emb
10002977	F19100634	A5 60h	lado largo	5	5
10002978	F19100635	A4 120h	lado largo	5	5
10002979	F19100636	A5 60h	lado corto	5	5
10002980	F19100637	A4 120h	lado corto	5	5
10002981	F19100638	30x30cm 120h	lado corto	5	5
10002982	F19100639	A3 120h	lado corto	5	5



Bloc de dibujo 1264 Bristol técnicas mixtas
encolado liso 200g - 50 hojas

Código	Referencia	Artículo	U/Vta	U/Emb
10002991	F19100654	A4	5	5
10002992	F19100655	A3	5	5

Bloc de dibujo 1264 Mix Media técnicas mixtas
espiral lado corto grano natural, 300g

Código	Referencia	Artículo	U/Vta	U/Emb
10002986	F19100642	A5 15h	5	5
10002987	F19100643	A4 30h	5	5
10002988	F19100644	A3 30h	5	5



Bloc de dibujo 1264 técnicas mixtas
espiral lado corto grano natural, 180g

Código	Referencia	Artículo	U/Vta	U/Emb
10002983	F19100645	A5 30h	5	5
10002984	F19100646	A4 50h	5	5
10002985	F19100647	A3 50h	5	5



Bloc de dibujo 1264 técnicas mixtas
grano natural, 90g - 100hojas

Código	Referencia	Artículo	U/Vta	U/Emb
10002975	F19100632	A4	5	5
10002976	F19100633	A3	5	5

Bloc de dibujo 1264 Marker técnicas mixtas
encolado liso efecto barrera, 70g - 100hojas

Código	Referencia	Artículo	U/Vta	U/Emb
10002993	F19100640	A4	5	5
10002994	F19100641	A3	5	5



Bloc de dibujo 1264 Black Drawing
espiral lado corto, rugoso - 200g

Código	Referencia	Artículo	U/Vta	U/Emb
10003022	F19100651	A5 20h	5	5
10003027	F19100652	A4 40h	5	5
10003035	F19100653	A3 40h	5	5



Bloc de dibujo 1264 WaterColor para acuarela
espiral lado corto, grano fino - 300g

Código	Referencia	Artículo	U/Vta	U/Emb
10002999	F19100648	A5 20h	5	5
10003006	F19100649	A4 30h	5	5
10003010	F19100650	A3 30h	5	5



Bloc de dibujo Layout-Marker técnicas mixtas
encolado 75g - 70hojas

Código	Referencia	Artículo	U/Vta	U/Emb
10003080	F19100505	A4	1	5
10003081	F19100506	A3	1	5



PAPEL DE DIBUJO

Láminas de dibujo liso 130g grano natural
Sobre de 10h + 5 hojas gratis

Código	Ref.	Artículo	U/Vta	U/Emb
10801204	F74021297	A4	10	10
10801099	F74029742	A3	10	10



PAPEL DE DIBUJO

Láminas de dibujo 130g grano natural
Sobre de 10

Código	Ref.	Artículo	U/Vta	U/Emb
10801098	F74112432	24 x 32 C/R	10	10
10801097	F74002432	24 x 32 Lisa	10	10



PAPEL TÈMPERA - ACUARELA

Láminas para acuarela 350g
Sobre de 6 + 2 hojas gratis

Código	Ref.	Artículo	U/Vta	U/Emb
10801100	F74233285	A4+	10	10
10801195	F74233286	A3+	10	10



Bloc de dibujo encolado Mixed Media 40h
250gr
Técnicas mixtas (secas y húmedas)

Código	Ref.	Artículo	U/Vta	U/Emb
10002734	19100502	A5	1	5
10002732	19100381	A4	1	5
10002733	19100382	A3	1	5



Bloc de dibujo Bristol Illustrazione 20h
250gr

Código	Ref.	Artículo	U/Vta	U/Emb
10002737	19100503	A5	1	5
10002735	19002129	A4	1	5
10002736	19002942	A3	1	5



Bloc de dibujo espiral Esbozo Schizzi 90gr
microperforado

Código	Ref.	Artículo	Hojas	U/Vta	U/Emb
10002738	56614821	A5	60h	1	5
10002739	56621297	A4	120h	1	5
10002740	56629742	A3	100h	1	5
10002741	56642594	A2	60h	1	5



Papel de color Copy Tinta 80g,
para fotocopias, impresión, láser y inkjet, y fax.

Paquete A4 - 500 HOJAS

Código	Ref.	Color	U/Vta	U/Emb
12701218	F61321297	Albaricoque	1	5
12701217	F61121297	Amarillo banana	1	5
12701206	F60621297	Amarillo	1	5
12701211	F68821297	Azul	1	5
12701210	F60321297	Azul cielo	1	5
12701215	F61021297	Cedro	1	5
12701223	F60721297	Azul celeste	1	5
12701222	F66321297	Azul claro	1	5
12701395	F68621297	Fucsia	1	5
12701226	F66421297	Gris	1	5
12701214	F69921297	Marfil	1	5
12701221	F60821297	Lavanda	1	5
12701208	F60421297	Naranja langosta	1	5
12701207	F68521297	Naranja	1	5
12701216	F66221297	Ónice	1	5
12701209	F60521297	Rojo	1	5
12701220	F66021297	Rosa claro	1	5
12701219	F61421297	Rosa	1	5
12701213	F60121297	Verde	1	5
12701212	F60221297	Verde pistacho	1	5
12701225	F61221297	Verde aguamarina	1	5
12701224	F66121297	Verde claro	1	5
12701396	F68721297	Violeta	1	5

Paquete A3 - 250 HOJAS

Código	Ref.	Color	U/Vta	U/Emb
12701197	F61329742	Albaricoque	1	7
12701196	F61129742	Amarillo banana	1	7
12701183	F60629742	Amarillo	1	7
12701189	F60329742	Azul	1	7
12701190	F68829742	Azul cielo	1	7
12701194	F61029742	Cedro	1	7
12701202	F60729742	Azul celeste	1	7
12701201	F66329742	Azul claro	1	7
12701187	F68629742	Fucsia	1	7
12701205	F66429742	Gris	1	7
12701193	F69929742	Marfil	1	7
12701200	F60829742	Lavanda	1	7
12701185	F60429742	Naranja langosta	1	7
12701184	F68529742	Naranja	1	7
12701195	F66229742	Ónice	1	7
12701186	F60529742	Rojo	1	7
12701199	F66029742	Rosa claro	1	7
12701198	F61429742	Rosa	1	7
12701191	F60229742	Verde pistacho	1	7
12701192	F60129742	Verde	1	7
12701204	F61229742	Verde aguamarina	1	7
12701203	F66129742	Verde claro	1	7
12701188	F68729742	Violeta	1	7



Papel de color A4, 100 hojas 80g

Código	Ref.	Artículo	U/Vta	U/Emb
12701228	11303	Surtido intenso	1	25
12701227	11302	Surtido pastel	1	25



Plástico adhesivo transparente 100µ

Código	Ref.	Artículo	U/Vta	U/Emb
11801078	45050090	0,90x20m	1	6
11801010	45050045	0,45x20m	1	6

Plástico adhesivo rollo 0,45 x 20m madera 100µ

Código	Ref.	Color	U/Vta	U/Emb
11801014	45100045	Intermedio	1	6

Plástico adhesivo PVC rollo 0,45 x 20m brillo 100µ

Código	Ref.	Color	U/Vta	U/Emb
11801118	45500045	Blanco	1	6
11801114	45506045	Negro	1	6
11801115	45505045	Rojo	1	6

Plástico adhesivo PVC rollo 0,90 x 20m mate 100µ

Código	Ref.	Color	U/Vta	U/Emb
11801200	45900090	Blanco	1	6

Plástico adhesivo PVC rollo 0,45 x 20m mate 100µ

Código	Ref.	Color	U/Vta	U/Emb
11801041	45900045	Blanco	1	6
11801085	45912045	Gris	1	6
11801021	45904045	Naranja	1	6
11801044	45905045	Rojo	1	6
11801040	45911045	Negro	1	6

Terciopelo adhesivo rollo 0,45 x 10m

Código	Ref.	Color	U/Vta	U/Emb
11801055	45206045	Granate	1	6
11801113	45208045	Gris Azulado	1	6
11801036	45204045	Negro	1	6
11801076	45200045	Ocre	1	6
11801034	45201045	Rojo	1	6
11801088	45207045	Rosa	1	6
11801033	45202045	Verde	1	6

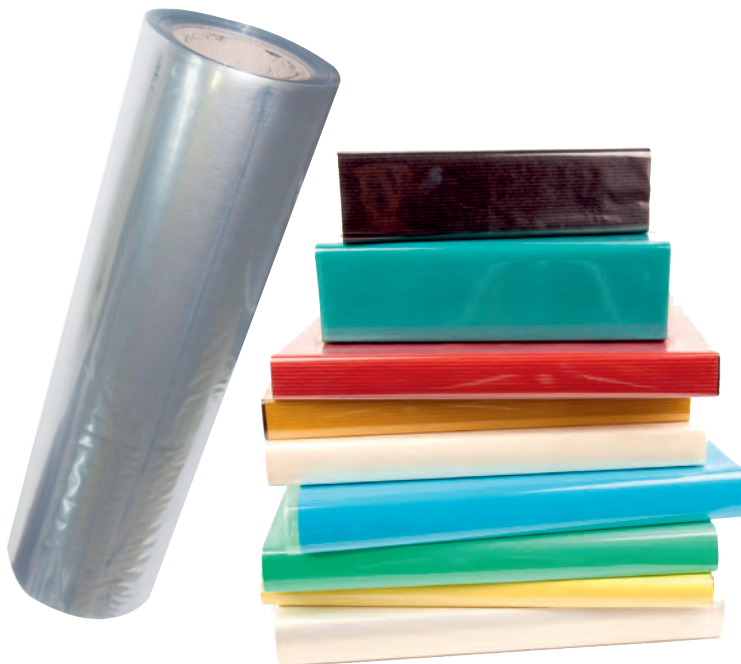

Forro en bobina 100 metros

Código	Ref.	Ancho	U/Vta	U/Emb
11801011	B12990 450	0,45 x 100m	1	1
11801012	B12990 700	0,70 x 100m	1	1
11801013	B12990 1400	1,40 x 100m	1	1



Forro en rollo 2 metros

Código	Ref.	Artículo	U/Vta	U/Emb
11801020	P12987 R2-45	0,45 x 2m	100	100
11801004	P12987 R2-35	0,35 x 2m	100	100

Forro en rollo 5 metros

Código	Ref.	Artículo	U/Vta	U/Emb
11801069	P12987 R5-45	0,45 x 5m	60	60

DISTRISANTIAGO
DISTRIBUIDOR EXCLUSIVO
PARA TODA ESPAÑA



Clips labiado niquelado - Caja de 100

Código	Ref.	Tamaño	U/Vta	U/Emb
12101065	J350215	nº1,5 (26 mm.)	10	10
12101066	J35022	nº2 (32 mm.)	10	10
12101067	J35023	nº3 (42 mm.)	10	10

Clips labiado galvanizado

Código	Ref.	Tamaño	Caja	U/Vta	U/Emb
12101068	J450215	nº1,5 (26 mm.)	100	10	10
12101069	J45022	nº2 (32 mm.)	100	10	320
12101070	J45023	nº3 (42 mm.)	100	10	160
12101071	J45024	nº4 (50 mm.)	80	10	10



Clip Mariposa

Código	Ref.	Tamaño	Caja	U/Vta	U/Emb
12101072	J450510	nº10 (40 mm.)	50	1	10
12101073	J450520	nº20 (60 mm.)	25	1	10

Fáster metal dorado
Caja de 50

Código	Ref.	U/Vta	U/Emb
19101025	J900050	1	1



N
Nuevos modelos

Puzzle educativo circular 48 piezas

Código	Ref.	Artículo	U/Vta	U/Emb
28301536	18200	Sistema solar	1	1
28301537	18201	Mapamundi	1	1
28301550	19134	Biosfera	1	1
28301551	19135	Monumentos	1	1



N
Nuevos modelos

Puzzle educativo

Código	Ref.	Artículo	U/Vta	U/Emb
28301516	17196	Sumas y transportes (30 piezas)	1	1
28301518	14406	Origen de las cosas (36 piezas)	1	10
28301451	14360	Origen de los alimentos (36 piezas)	1	12



Juego educativo Kids 3 en 1

Código	Ref.	Artículo	U/Vta	U/Emb
25901611	18797	In the city (transporte, nº y profesiones)	1	6
25901612	18798	Animales (puzzle, domino y memory)	1	6



Puzzle educativo 24 piezas Expositor de 6

Código	Ref.	U/Vta	U/Emb
28300777	13856	1	1



N
Nuevo modelo

Juegos magnéticos

Código	Ref.	Artículo	U/Vta	U/Emb
25001142	14803	Estados de ánimo (30 piezas)	1	8
25001171	16494	Mapa mundi (40 piezas)	1	8
25001151	16816	Letras (60 piezas)	1	8
25001251	18573	Las horas (96 piezas)	1	1
25001250	18531	Cuerpo humano (63 piezas)	1	1
25001297	19272	Sistema sola (27 piezas)	1	1



Novedad
N

Mapas puzzle educativo magnético

Código	Ref.	Artículo	U/Vta	U/Emb
28301552	18893	España (50 piezas)	1	1
28301553	19246	Europa (45 piezas)	1	1

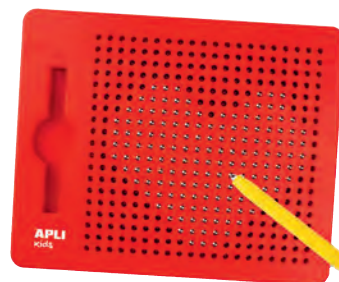

Pizarra magnética

Código	Ref.	Artículo	U/Vta	U/Emb
25001241	17536	215x12x170mm	1	30
23801806	18792	315x18x257mm	1	17



Pizarra blanca 18x28cm con dos rotuladores y borrador

Código	Ref.	U/Vta	U/Emb
23801767	12916	1	20

Gomets de colores en rollo

• CÍRCULO

Color	Metalizado Ø10,5		Metalizado Ø 15		Metalizado Ø 20		Metalizado Ø 45	
	Código	Ref.	Código	Ref.	Código	Ref.	Código	Ref.
● Amarillo					18804192	12047		
● Azul					18804193	12048		
● Rojo					18804194	12049		
● Verde					18804195	12050		
● Oro	18804075	11626	18804056	11629	18804057	11632	18801717	18483
● Plata	18804076	11627	18804078	11630	18804173	11633	18801718	18484
● Holográfico	18804077	11628	18804058	11631	18804174	11634		

Color	Ø 10,5		Ø 15		Ø 20	
	Código	Ref.	Código	Ref.	Código	Ref.
● Amarillo	18804010	04851	18804014	04855	18804002	04859
● Azul	18804011	04852	18804015	04856	18804003	04860
● Rojo	18804012	04853	18804016	04857	18804004	04861
● Verde	18804013	04854	18804017	04858	18804005	04862
● Naranja	18804063	11477	18804066	11483	18804061	11488
● Rosa	18804064	11479	18804067	11484	18804049	11489
● Lila	18804050	11480	18804068	11485	18804083	11490
● Marrón	18804047	11481	18804069	11486	18804060	11491
● Negro	18804065	11482	18804052	11487	18804048	11492
○ Blanco	18804181	11903	18804122	11904	18804182	11905

• RECTÁNGULOS

Color	20x10	
	Código	Ref.
● Amarillo	18804033	04883
● Azul	18804034	04884
● Rojo	18804035	04885
● Verde	18804036	04886

• TRIÁNGULO

Color	20x20x20		10,5x10,5x10,5	
	Código	Ref.	Código	Ref.
● Amarillo	18804006	04867	18804018	04863
● Azul	18804007	04868	18804019	04864
● Rojo	18804008	04869	18804020	04865
● Verde	18804009	04870	18804001	04866
● Naranja	18804070	11493		
● Rosa	18804071	11494		
● Lila	18804072	11495		
● Marrón	18804073	11496		
● Negro	18804074	11497		
○ Blanco	18804183	11906		

• CUADRADO

Color	20x20		10x10	
	Código	Ref.	Código	Ref.
● Amarillo	18804025	04875	18804021	04871
● Azul	18804026	04876	18804022	04872
● Rojo	18804027	04877	18804023	04873
● Verde	18804028	04878	18804024	04874
● Naranja	18804164	11498		
● Rosa	18804053	11499		
● Lila	18804054	11500		
● Marrón	18804059	11501		
● Negro	18804051	11502		
○ Blanco	18804184	11907		

• ESTRELLA

Color	Surtido		Metalizada 33mm		Metalizada grande		Metalizada surtido	
	Código	Ref.	Código	Ref.	Código	Ref.	Código	Ref.
● Amarillo	18804037	04887			18804196	12051		
● Azul	18804038	04888			18804197	12052		
● Rojo	18804039	04889			18804198	12053		
● Verde	18804040	04890			18804199	12054		
● Oro			18801670	17866	18804189	12044	18804045	11116
● Plata			18801671	17867	18804190	12045	18804046	11117
● Holográfico					18804191	12046	18804062	11635



Gomets en rollo CORAZÓN Ø 20 mm

Código	Ref.	Color	U/Vta	U/Emb
18801537	16731	Rojo	1	1
18801538	16796	Multicolor	1	1

Gomets formas en rollo 720 uds

Código	Ref.	Color	U/Vta	U/Emb
18801602	17614	Oro	1	36
18801603	17615	Plata	1	36

Gomets Ojos surtidos rollo 1380 uds

Código	Ref.	U/Vta	U/Emb
18801601	17613	1	36

Gomets figuras geométricas Pack 4 colores (amarillo, azul, rojo y verde)



Código	Ref.	Artículo	U/Vta	U/Emb
18804136	10753	Surtido XL - 27mm	1	8
18804185	11913	Surtido XL - 27mm*	1	8
18801719	18804	Surtido - 20mm	1	8
18801660	18326	Cuadrado - 20mm	1	8
18804347	13793	Círculo - Ø 20 mm	1	8
18801549	14769	Círculo - Ø 33 mm	1	8
18801604	17634	Círculo - Ø 45 mm	1	8
18801750	19192	Hexágono - 27mm	1	8
18801834	19502	Corazón	1	1

*Colores: naranja, rosa, lila y marrón



Gomets en rollo Emociones 30h círculo Ø 33mm removable

Código	Ref.	U/Vta	U/Emb
18801720	18771	1	36



Gomets educativos rollo 30h Ø 20mm CARA FELIZ

Código	Ref.	Color	U/Vta	U/Emb
18801318	14373	Verde	1	1
18801334	14374	Dorado	1	1





Gomets temáticos 2 hojas

Código	Ref.	Artículo	U/Vta	U/Emb
18804305	13352	Vestirse de niña	5	600
18804306	13353	Vestirse de niño	5	600
18801544	16623	Huerto	5	600
18801540	16619	Animales de granja	5	600
18801542	16621	Animales Sabana	5	600
18801606	17628	Mascotas	5	600
18801607	17630	Aves	5	600
18801608	17632	Reptiles y anfibios	5	600
18801726	18729	Animales marinos	5	600
18801727	18730	Mariposas	5	600
18801728	18731	Insectos	5	600
18801729	18733	Animales del bosque	5	600
18801730	18734	Animales de la sabana	5	600

Gomets temáticos 3 hojas

Código	Ref.	Artículo	U/Vta	U/Emb
18804143	11431	La granja	5	500
18804144	11432	El bosque	5	500
18804145	11433	La selva	5	500
18804147	11435	La playa	5	500
18804148	11436	La escuela	5	500
18804119	11438	El armario	5	500
18804120	11439	Frutas y verduras	5	500
18804149	11440	Profesiones	5	500
18804150	11441	Deportes	5	500
18804151	11442	Transportes	5	500
18804165	11614	Primavera	5	500
18804166	11615	Verano	5	500
18804167	11616	Otoño	5	500
18804168	11617	Invierno	5	500
18801731	18770	Emociones	5	500
18801742	19223	Motivacionales	5	500
18801744	19225	El espacio (grande)	5	500
18801746	19227	Alimentos saludables	5	500



Gomets educativos en hojas

Tema	2 hojas		12 hojas	
	Código	Ref.	Código	Ref.
Cara	18804115	11867	18804186	11927
Cuerpo	18804116	11868	18804187	11928
Las horas	18804211	12789*	18804308	12790
El tiempo	18804241	12946*		
Ojos - Azules	18804350	13854*		
Sistema solar	18801479	15173	18801480	15174
ABC	18801546	16726*	18801547	16727
El espacio			18801745	19226

*3 hojas

Gomets metalizados Bolsa de 3 hojas

Código	Ref.	Artículo	U/Vta	U/Emb
18804099	11805	Estrella oro	10	870
18804100	11806	Estrella plata (surtido)	10	870
18804101	11807	Estrella holográfica (surtido)	10	870
18804200	12055	Estrella holográfica rosa (surtido)	10	870
18804201	12056	Estrella holográfica lila (surtido)	10	870
18804202	12057	Estrella holográfica azul (surtido)	10	870
18804104	11808	Círculo Ø 20mm oro	10	870
18804105	11809	Círculo Ø 20mm plata	10	870
18804103	11810	Círculo Ø 20mm holográfica	10	870



Gomets en bolsa 6 hojas

Código	Ref.	Artículo	Adhesivo	U/Vta
18804300	12970	Círculos 7 colores	Removible	10
18804301	12971	Cuadrados 7 colores	Removible	10
18804309	13239	Triángulos 7 colores	Removible	10
18804310	13240	Formas surtidas 7 colores	Removible	10
18801722	18463	Círculos 7 colores	Removible	10
18801723	18767	Corazón 7 colores	Removible	10
18801835	19452	Corazón colores Nordik	Removible	10
18801724	18768	Hexágono 7 colores	Removible	10
18801836	19453	Estrellas 7 colores	Removible	10
18801837	19472	Hojas 7 colores	Removible	10
18804317	13529	Círculos 7 colores metal	Permanente	10
18804318	13530	Cuadrados 7 colores metal	Permanente	10
18801721	18396	Estrellas 7 colores metal	Permanente	5
18801725	18769	Círculos 7 colores kraft	Permanente	10



Gomets en bolsa FORMAS

Código	Ref.	Artículo	Adhesivo
18804085	00706	Figuras varias (4 colores surtidos) 20 hjs	Permanente
18804098	00993	Figuras geom. pequeñas (4 colores surtidos) 12 hjs	Permanente
18804095	00994	Figuras geom. grandes (4 colores surtidos) 12 hjs	Permanente
18804137	11102	Figuras varias (4 colores surtidos) 20 hjs	Removible
18804138	11108	Figuras geom. pequeñas (4 colores surtidos) 12 hjs	Removible
18804139	11109	Figuras geom. grandes (4 colores surtidos) 12 hjs	Removible



Gomets en rollo multicolor removible Ø 20mm

Código	Ref.	Artículo	U/Vta	U/Emb
18801473	15126	ABC mayus	1	36
18801474	15127	123	1	36
18801536	16798	ABC minus	1	36
18801535	16797	Vocales	1	36



Gomets cara feliz, 12 hojas

Código	Ref.	Artículo	U/Vta	U/Emb
18804117	11680	Cara Feliz 1	5	
18801335	14811	Cara Feliz 2	5	
18801548	16801	Cara Feliz pequeña	5	



Etiquetas adhesivas manuales tamaños surtidos Bolsa de 35

Código	Ref.	Artículo	U/Vta	U/Emb
18801714	17793	Termoadhesiva	1	500
18801715	17794	Plastificadas	1	500



Cartulina A4 170 gramos paquete de 50 hojas

Código	Ref.	Artículo
10701417	15116	Colores surtidos pastel
10701418	15117	Colores surtidos intenso

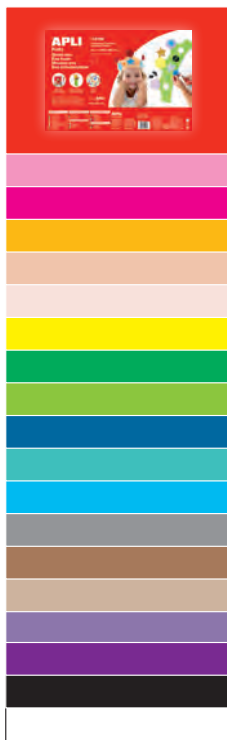

Plancha goma EVA 20x30

Código	Ref.	Artículo
25208161	12372	10 colores
25208176	12785	4 hjs purpurina (oro, plata, verde y rojo)
25208713	13171	4 hjs purpurina (rojo, azul, blanco y negro)
25208714	13177	4 hjs efecto toalla (rojo, amarillo, verde y azul)
25208883	13556	4 hojas flúor (rosa, amarillo, verde y naranja)
25201787	18883	4 hojas foam 5mm (rojo, verde, amarillo y azul)



Formas de goma Eva sin adhesivo

Código	Ref.	Artículo
25208884	13074	Letras
25208885	13075	Números
25208888	13073	Formas geométricas

Goma EVA 40x60 Paquete de 5

Código	Ref.	Color
25208162	12756	Rojo
25208163	12757	Rosa
25208867	13692	Fucsia
25208164	12758	Naranja
25208165	12759	Piel
25208868	13347	Piel claro
25208166	12760	Amarillo
25208167	12761	Verde
25208168	12762	Verde claro
25208169	12763	Azul
25208170	12764	Azul claro
25208171	12765	Gris
25208172	12766	Marrón
25208173	12767	Morado
25208174	12768	Negro
25208175	12769	Blanco



Perforadora goma EVA 25,4 mm

Código	Ref.	Artículo
25208715	13298	Estrella naranja
25208716	13299	Tulipán rojo
25208717	13300	Corona rosa
25208718	13301	Redondo lila
25208719	13302	Copo nieve azul
25208720	13303	Árbol verde



Goma Eva Maxi adhesiva de colores Bolsa de 500

Código	Ref.	Artículo	U/Vta	U/Emb
25201534	17438	Números	1	12
25201535	17439	Letras	1	12
25201784	18752	Caras	1	20



Formas de goma Eva adhesivas

Código	Ref.	Artículo
25208750	13078	Flores purpurina
25208889	13283	Corazones purpurina
25208890	13484	Corazones color purpurina
25208891	13485	Estrella color purpurina
25208892	13486	Números color purpurina
25208893	13487	Alfabeto color purpurina
25208894	13488	Copo de nieve purpurina
25201207	15139	Corazones
25201208	15140	Flores
25201783	18751	Purpurina
25201785	18971	Estrellas oro y plata
25201786	18972	Dinosaurios

Goma EVA 40x60 PURPURINA Paquete de 3

Código	Ref.	Color
25208871	13172	Rojo
25208872	13173	Verde
25208873	13175	Oro
25208874	13176	Plata
25208875	13435	Azul
25208882	13436	Surtido*

*Paquete de 5



Ovillos de lana 50 g de colores. Pack de 4

Código	Ref.	Artículo
25213013	14090	Verdes
25213014	14091	Rojos
25213015	14092	Azules
25213016	14093	Flúor



Ovillos de rafia 30m de colores Bolsa de 3

Código	Ref.	Artículo
25201131	14412	Flúor
25201132	14413	Nature
25201133	14414	Marine
25201134	14415	Candy



Alambres de colores 1,5mm

Código	Ref.	Artículo
25213017	14094	Alambre negro
25213018	14095	Alambre plateado
25213019	14096	Alambre verde
25213020	14097	Alambre rojo
25213021	14098	Alambre azul
25213022	14099	Alambre lila
25213023	14100	Alambre dorado



Pinzas de madera colores surtidos Maxi

Código	Ref.	Artículo	Bolsa	U/Vta	U/Emb
25201547	17449	Colores 25x3mm	450 uds	1	30
25201624	18154	Madera 46x6cm	400 uds	1	10



Ojos móviles

Código	Ref.	Artículo	Bolsa	Forma	Adhesivo
19501051	13058	Negros	75 uds	Redondos	No
19501052	13059	Color	40 uds	Ovalados	Si
19501053	13263	Negros	100 uds	Redondos	Si
19501054	13264	Negros	100 uds	Ovalados	Si
19501055	13265	Pestañas color	100 uds	Redondos	Si
19501056	13266	Pupila color	100 uds	Redondos	Si



Ojos móviles Maxi Bolsa surtida de 600

Código	Ref.	Artículo	U/Vta	U/Emb
25201543	17444	Fondo blanco	1	60
25201621	18155	Fondo colores	1	60



Plumas colores surtidos

Código	Ref.	Artículo
25208746	13060	Plumas 100uds 7/16cm
25208913	13281	Plumas 24uds 14g



Plumas de colores Maxi
Bolsa surtida

Código	Ref.	Artículo	U/Vta	U/Emb
25201544	17445	Bolsa de 500	1	12
25201625	18156	7-16cm (bolsa de 400)	1	10



Palillos planos de madera Maxi
Tamaños surtidos

Código	Ref.	Artículo	U/Vta	U/Emb
25201541	17453	Colores (bolsa de 500)	1	20
25201542	17454	Natural (bolsa de 800)	1	10



Manualidades de madera

Código	Ref.	Artículo	Color	Bolsa
25208902	13063	Palo plano natural		50 uds
25208903	13064	Palo plano colores		50 uds
25208904	13268	Palo plano jumbo natural		40 uds
25208905	13269	Palo plano jumbo colores		40 uds
25201790	18970	Palo redondo natural mini		80 uds
25208906	13482	Palo redondo colores		25 uds
25208907	13483	Palo redondo pincho		50 uds
25201619	18157	Mini palillos colores maxi		1500 uds
25208908	13478	Minipinzas de madera		45 uds
25208909	13479	Minipinzas de madera		45 uds
25208910	13480	Pinzas de madera		20 uds
25201314	13481	Botones tamaños variados		30 uds



Pom pom Maxi colores surtidos
Bolsa de 500

Código	Ref.	U/Vta	U/Emb
25201546	17448	1	6



Pompones en bolsa

Código	Ref.	Artículo	Bolsa	U/Vta	U/Emb
25201789	18968	Mini	200 uds	5	250
25208911	13061	Básicos	78 uds	5	60
25208912	13062	Brillante	78 uds	5	60
25201788	18753	Brillante	400 uds	1	20



Bolas polispán

Código	Ref.	Artículo	Bolsa
25210033	13278	Ø 25 mm	10 uds
25210034	13279	Ø 45 mm	4 uds
25210035	13475	Ø 50 mm	4 uds
25210036	13280	Ø 60 mm	2 uds
25210037	13476	Ø 70 mm	2 uds
25210038	13477	Ø 80 mm	1 uds



Bolas poliespan Maxi
Bolsa tamaños surtidos de 100

Código	Ref.	U/Vta	U/Emb
25201545	17456	1	5



Pistola de cola y cola termofusible (7,5mm Ø)

Código	Ref.	Artículo
23108004	16668	Pistola de cola 20W
23108005	13243	10 barras de cola de 10 cm
23101049	13740	25 barras de cola de 10 cm
23101226	17003	25 barras de cola de 20 cm
23108006	13800	12 barras de cola de 10 cm glitter



Limpiapiipas 300x5mm

Código	Ref.	Artículo	Color	Bolsa
25201315	13065	Limpiapiipas		50 uds
25201316	13066	Limpiapiipas brillante		50 uds
25201317	13270	Limpiapiipas neón		50 uds
25201318	13271	Limpiapiipas twist!		50 uds
25201319	13272	Limpiapiipas		50 uds
25201320	13273	Limpiapiipas		50 uds
25201321	13274	Limpiapiipas		50 uds
25201322	13275	Limpiapiipas		50 uds
25201323	13276	Limpiapiipas		50 uds
25201324	13277	Limpiapiipas		50 uds
25201618	18153	Limpiapiipas surtido Maxi	Brillante+claro	360 uds



Cola glitter glue lápiz
Blister de 5

Código	Ref.	Artículo	U/Vta	U/Emb
23101161	13223	Metalizada	1	36
23101162	13224	Neón	1	36
23501612	17611	Arcoiris (3D)	1	36
23101385	18973	Metalizado (3D)	1	54



Purpura en polvo bote
Blister de 6 surtidos

Código	Ref.	Artículo	U/Vta	U/Emb
23501143	13343	Col. Básicos metalizados	1	36
23501611	17609	Col. Brillantes flúor	1	1
23101386	18974	Col. Holográficos	1	60



Anillas metálicas articuladas

Código	Ref.	Medidas	Caja de
13301001	00451	Ø 20 mm	20
13301002	00452	Ø 25 mm	20
13301003	00453	Ø 32 mm	20
13301004	00454	Ø 38 mm	20
13301005	00455	Ø 46 mm	10



Chinchetas 50 uds

Código	Ref.	Artículo
12001016	11725	Niquelada
12001017	11733	colores surtidos



Fásterens. Caja de 50

Código	Ref.	Artículo	U/Vta	U/Emb
19101021	11831	Dorados	1	25
19101034	14909	Colores surtidos	1	25



Encuadernadores

* Sin arandelas

Código	Ref.	Medidas	Caja de
18101616	12285	18 mm	100
18101620	12577	25 mm	100
18101617	12286	30 mm	100
18101618	12287	40 mm	100
18101619	12288	50 mm	100
18101614	*12283	12 mm	100
18101615	*12284	17 mm	100



Masilla Tack adhesiva

Código	Ref.	Artículo
23104069	11703	Azul 57 g
23104070	11803	Blanca 75 g cuarteado



Cinta de velcro adhesiva 2cm x 25m

Código	Ref.	Artículo	U/Vta	U/Emb
11901403	14903	Blanco	1	20
11901404	17018	Negro	1	20



Cinta adhesiva doble cara Rollo 20m x 15mm

Código	Ref.	U/Vta	U/Emb
11901412	17723	1	32



Cinta adhesiva magnética Rollo 2,5m x 19mm

Código	Ref.	U/Vta	U/Emb
11901408	17724	1	32



Tablas de corte

Código	Ref.	Medidas
25208137	13563	900 x 600 x 2 mm (A1)
25208034	13564	600 x 450 x 2 mm (A2)
25208039	13565	450 x 300 x 2 mm (A3)
25208033	13566	300 x 220 x 2 mm (A4)



Cuerda silicona 0,7mm x 100m

Código	Ref.
25201135	14049



Goma elástica nylon 0,35mm x 100m

Código	Ref.
25213024	13808



Goma elástica textil 100m

Código	Ref.	Artículo	U/Vta	U/Emb
25213025	13809	Negro - 2mm	1	1
25201693	18675	Blanco - 5mm	1	30



Cinta adhesiva rollo 33x19

Código	Ref.	Color	U/Vta	U/Emb
11901364	12272	Roja	8	240
11901365	12273	Azul	8	240
11901366	12274	Amarilla	8	240
11901367	12275	Verde	8	240
11901368	12276	Negra	8	240
11901369	12277	Blanco	8	240



Cinta adhesiva transparente rollo 33x19

Código	Ref.	U/Vta	U/Emb
11901327	11103	35	35



CON MINI PORTARROLLOS

Cinta adhesiva transparente rollo 33x19

Código	Ref.	U/Vta	U/Emb
11901231	12094	8	8



Forro sin adhesivo autoajustable 130µ Caja de 100

Código	Ref.	Medida
11801151	12280	290 mm
11801195	12281	300 mm



Forro adhesivo transparente

Código	Ref.	Medida
11801147	00262	1,50 x 0,50 - 50 µ
11801149	00264	20 x 0,50 - 80 µ
11801150	00429	3 x 0,50 - 80 µ



Portatizas colores surtidos

Código	Ref.	Artículo	U/Vta	U/Emb
27901069	19025	Normal	1	192
27901070	19026	Jumbo	1	48



Tizas 9 mm de diámetro

Código	Ref.	Unidades / Color
27901049	14574	10 ud / Multicolor
27901050	14575	100 ud / Multicolor
27901051	14576	10 ud / Blanco
27901052	14577	100 ud / Blanco



Tizas Jumbo

Código	Ref.	Unidades / Color
27901047	14367	6 ud / Multicolor
27901048	14370	6 ud / Blanco
27901057	14855	Bote de 20 (6 colores)



Roller adhesivo permanente cassette 10m Doble cara

Código	Ref.	U/Vta	U/Emb
23104071	11037	10	10



Adhesivo instantáneo 10g

Código	Ref.	Artículo	U/Vta	U/Emb
23103103	13350	Sin pincel	12	360
23105002	13677	Con pincel	12	120



Cola silicona líquida 100ml Expositor de 12

Código	Ref.	U/Vta	U/Emb
23106001	13349	1	4



Cola blanca y barniz

Código	Ref.	Artículo
23101117	12848	Cola blanca 40 g
23101118	12849	Cola blanca 100 g
23101119	12850	Cola blanca 250 g
23101120	12851	Cola blanca 1000 g
25209146	13620	Barniz 100 ml
25209147	13621	Barniz 750 ml

Silicona líquida 500ml

Código	Ref.	U/Vta	U/Emb
23101225	17409	1	12



Portatodo Expositor de 12

Código	Ref.	Artículo	U/Vta	U/Emb
11301889	18368	Nordik - silicona triangular	1	12
11301958	19028	Neopreno Urban rectangular	1	12



Portatodo silicona rectangular Expositor de 12

Código	Ref.	Artículo	U/Vta	U/Emb
11301884	16300	Soft flúor	1	1
11301883	17408	Nordik	1	1



Portatodo Up North rectangular silicona Expositor de 16

Código	Ref.	U/Vta	U/Emb
11302103	19498	1	1



Portalápices Urban neopreno Expositor de 12

Código	Ref.	U/Vta	U/Emb
30501152	19194	1	12



Novedad
N

**Marcador flúor retractable
Blíster de 4**

Código	Ref.	Color	U/Vta	U/Emb
10204432	18932	Flúor	5	5
10204433	18933	Pastel	5	5



Novedad
N

**Rotulador doble metalizados
Estuche de 6 surtido**

Código	Ref.	U/Vta	U/Emb
10203968	18931	1	1



Novedad
N

Rotulador doble punta (redonda y pincel)

Código	Ref.	Artículo	U/Vta	U/Emb
10204976	18574	Estuche de 6 Pastel	1	1
10204788	19153	Estuche de 12 Vintage	1	1
10203468	18063	Estuche de 12	1	1
10204808	19193	Estuche de 24	1	1



Novedad
N

**Bolígrafo 5 colores pastel
Expositor de 20**

Código	Ref.	U/Vta	U/Emb
10101364	18307	1	20



Novedad
N

**Bolígrafo glitter
Expositor de 20**

Código	Ref.	U/Vta	U/Emb
10101390	18686	1	20



Novedad
N

**Portaminas 2,0mm
Expositor de 24**

Código	Ref.	U/Vta	U/Emb
12501155	18915	1	24



**Etiqueta impresora
cantos rectos (100 hojas)**

Código	Ref.	Ancho	Alto
40401021	01290	70	67,7
40401019	01288	97	42,4
40401022	01291	97	67,7
40401025	01299	105	29
40401018	01287	105	35
40401007	01274	105	37
40401008	01275	105	40
40401010	01277	105	42,4
40401020	01289	105	48
40401023	01292	105	70
40401012	01279	105	74
40401013	01280	105	148
40401002	01264	210	148
40401014	01281	210	297
40401001	01263	64,6	33,8
40401003	01270	70	25,4
40401004	01271	70	30
40401005	01272	70	35
40401006	01273	70	37
40401009	01276	70	42,4
40401011	01278	105	57
40401015	01282	48,5	16,9
40401016	01283	38	21,2
40401056	01284	52,5	21,2
40401061	01285	48,5	25,4
40401017	01286	52,5	29,7



**Etiqueta escritura manual
cantos romos (6 hojas)**

Código	Ref.	Ancho	Alto
18802004	02667	8	12
18802006	02668	8	20
18802007	02669	10	16
18802008	02670	12	18
18802009	02671	12	30
18802010	02672	13	40
18802011	02673	13	50
18802012	02674	16	22
18802013	02675	19	27
18802014	02676	19	40
18802015	02677	20	50
18802016	02678	20	75
18802017	02679	22	32
18802018	02680	25	40
18802020	02681	26	54
18802021	02682	31	100
18802205	02683	34	53
18802023	02684	34	67
18802024	02685	38	102
18802026	02686	53	82
18802025	02687	53	100
18802027	02688	81	110



Papel inkjet transfer A4 para algodón

Código	Ref.	Artículo	U/Vta	U/Emb
40301079	04128	10h - Algodón blanco	1	55
40301147	10247	5h - Algodón oscuro	1	60



**Etiquetas A4 imantadas
8 unidades**

Código	Ref.
40401217	10245



N
Nuevo modelo

Papel Inkjet foto

Código	Ref.	Artículo	Acabado
12708001	12626	A4 120g 100h	Mate
40301267	04457	A3 200g 50h	Brillo
40301275	11804	A4 140g 100h	Brillo
40301211	11475	A4 180g 100h	Brillo
40301257	11476	10x15 180g 100h	Brillo



Bolígrafo retráctil Pyramid tinta azul
Expositor de 36

Código	Ref.	U/Vta	U/Emb
10101454	88505	1	24



Bolígrafo retráctil Ease tinta azul
Colores surtidos

Código	Ref.	U/Vta	U/Emb
10101449	80550	36	864



Bolígrafo retráctil Victory tinta azul
Colores surtidos

Código	Ref.	U/Vta	U/Emb
10101453	86076	12	144



Marcador flúor
Estuche de 4

Código	Ref.	U/Vta	U/Emb
10204425	80469	12	144



Marcador flúor
Expositor de 24

Código	Ref.	Color	U/Vta	U/Emb
10204424	80468	Vivos	1	6
10204431	89724	Pastel	1	6



Bolígrafo borrable
Blister de 3

Código	Ref.	U/Vta	U/Emb
10101462	80446	40	480



Roller gel Metallic-Glitter-Neon 1,0
Bolsa de 18

Código	Ref.	U/Vta	U/Emb
11201226	89530	1	128



Roller gel Metallic 1,0

Código	Ref.	Estuche	U/Vta	U/Emb
11201225	87402	6 uds	40	320
11201223	80786	12 uds	20	150



Roller gel Glitter 1,0

Código	Ref.	Estuche	U/Vta	U/Emb
11201224	83885	6 uds	40	320
11201222	80785	12 uds	20	160



Portaminas multi-section HB
Caja de 12

Código	Ref.	U/Vta	U/Emb
12501151	87413	1	144



Portaminas 0,7 mm
Colores surtidos

Código	Ref.	U/Vta	U/Emb
12501149	80488	36	216



Portaminas 2.0mm con afila
Caja de 12

Código	Ref.	U/Vta	U/Emb
12501152	87507	1	144



Lápiz de grafito HB con goma tabla de multiplicar

Código	Ref.	U/Vta	U/Emb
12802437	82099	100	2400



Lápiz de grafito HB eco Rainbow

Código	Ref.	U/Vta	U/Emb
12802442	88055	48	288



Lápiz de 4 colores Rainbow jumbo

Código	Ref.	U/Vta	U/Emb
12802445	80328	40	240



Lápices de colores Art Bicolor

Código	Ref.	Estuche	U/Vta	U/Emb
12802451	87710	12 uds (24 colores)	24	144
12802452	88018	18 uds (36 colores)	12	144



Lápices de colores Zoo hexagonal largos

Código	Ref.	Estuche	U/Vta	U/Emb
12802453	89500	6 uds	24	384
12802454	89501	12 uds	12	192
12802455	89502	18 uds	8	128



Lápices de colores Giraffe triangulares

Código	Ref.	Estuche	U/Vta	U/Emb
12802448	86140	6 uds	24	288
12802449	86141	12 uds	12	144
12802450	86143	18 uds	8	96



Rotulador de fibra Art Estuche de 12

Código	Ref.	U/Vta	U/Emb
10204428	88988	24	144



Rotulador de fibra Magic Jumbo Estuche de 12

Código	Ref.	U/Vta	U/Emb
10204427	80782	12	96



Rotulador Marker para bocetos

Código	Ref.	Estuche	U/Vta	U/Emb
10204429	89700	12 uds	12	96
10204430	89701	24 uds	6	48



Rotulador de fibra Fineliner 0,7 Bolsa de 12

Código	Ref.	U/Vta	U/Emb
11201227	80255	12	96





Afilalápiz con depósito
Bote surtido de 56

Código	Ref.	U/Vta	U/Emb
13701263	88831	1	12



Afilalápiz 2 usos con depósito
Expositor de 24

Código	Ref.	U/Vta	U/Emb
13701265	89504	1	24



Afilaborra 2 usos con depósito
Expositor de 20

Código	Ref.	U/Vta	U/Emb
13701264	89465	1	5



Afilaborra
Expositor de 36

Código	Ref.	U/Vta	U/Emb
13701262	87418	1	24



Corrector cinta 5mm x 3m
Colores surtidos

Código	Ref.	U/Vta	U/Emb
15101114	86079	48	1152



Tijeras escolares Zoo 13cm
Expositor de 30

Código	Ref.	U/Vta	U/Emb
27601276	82430	1	6



Tijeras 15,5cm
Expositor de 24

Código	Ref.	U/Vta	U/Emb
27601220	32002	1	4



Corrector cinta 5mm x 15m

Código	Ref.	U/Vta	U/Emb
15101113	83474	24	288

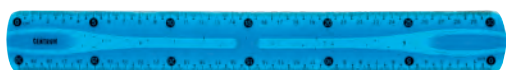

Regla flexible azul 30cm

Código	Ref.	U/Vta	U/Emb
25501134	86916	24	288

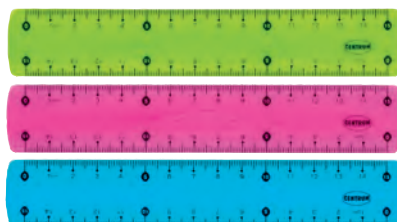

Regla flexible
Colores surtidos

Código	Ref.	Artículo	U/Vta	U/Emb
25501132	86638	15cm	48	480
25501133	86639	20cm	24	288



Tizas de colores Jumbo

Código	Ref.	Estuche	U/Vta	U/Emb
27901066	80390	3 uds	24	144
27901067	82426	6 uds	20	60

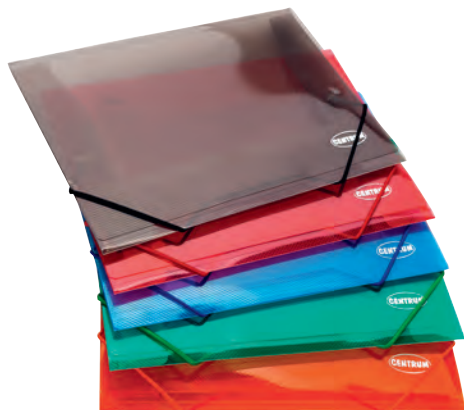

Carpeta de gomas y solapas polipropileno
colores surtido

Código	Ref.	Tamaño	U/Vta	U/Emb
10403825	80016	A4	24	120
10403824	80014	A5	60	240



Dosier sobre polipropileno
cierre con broche

Código	Ref.	Color	U/Vta	U/Emb
18001898	80626	A3	15	60
18001896	80024	A4	12	300
18001897	80625	A5	12	360

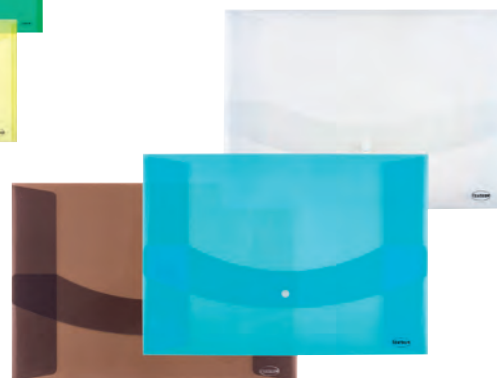



Carpeta de gomas y solapas A4 polipropileno

Código	Ref.	Color	U/Vta	U/Emb
10403727	91155	Azul	1	240
10403726	91154	Negro	1	240
10403729	91157	Rojo	1	240
10403728	91156	Verde	1	240

Carpeta de gomas y solapas A4 polipropileno traslúcido

Código	Ref.	Color	U/Vta	U/Emb
10403732	91161	Azul	1	240
10403730	91159	Blanco	1	240
10403733	91162	Rojo	1	240
10403731	91160	Verde	1	240

Carpeta de proyectos A4 3cm polipropileno con gomas

Código	Ref.	Color	U/Vta	U/Emb
10403735	91165	Azul	1	240
10403738	91168	Gris	1	240
10403734	91164	Negro	1	240
10403737	91167	Rojo	1	240
10403736	91166	Verde	1	240



Clasificador acordeón A4 polipropileno opaco 12 dptos. con gomas

Código	Ref.	Color	U/Vta	U/Emb
10301777	91184	Azul	1	40
10301776	91183	Negro	1	40



Clasificador acordeón A4 polipropileno opaco 13 dptos. con asa y broche

Código	Ref.	Color	U/Vta	U/Emb
10301779	91186	Azul	1	40
10301778	91185	Negro	1	40



Carpeta con pinza A4

• Miniclip superior

Código	Ref.	Color	U/Vta	U/Emb
10403724	91244	Azul	1	48
10403723	91243	Negro	1	48
10403725	91245	Rojo	1	48

• Portablocs

Código	Ref.	Color	U/Vta	U/Emb
10403721	91241	Azul	1	48
10403720	91240	Negro	1	48
10403722	91242	Rojo	1	48



Carpeta de fundas A4 PVC

• 10 fundas

Código	Ref.	Color	U/Vta	U/Emb
15302746	91198	Azul	1	200
15302745	91197	Negro	1	200
15302748	91200	Rojo	1	200
15302747	91199	Verde	1	200

• 20 fundas

Código	Ref.	Color	U/Vta	U/Emb
15302750	91202	Azul	1	160
15302749	91201	Negro	1	160
15302752	91204	Rojo	1	160
15302751	91203	Verde	1	160

• 30 fundas

Código	Ref.	Color	U/Vta	U/Emb
15302754	91206	Azul	1	120
15302753	91205	Negro	1	120
15302756	91208	Rojo	1	120
15302755	91207	Verde	1	120

• 40 fundas

Código	Ref.	Color	U/Vta	U/Emb
15302758	91210	Azul	1	100
15302757	91209	Negro	1	100
15302796	91212	Rojo	1	100
15302795	91211	Verde	1	100

• 60 fundas - negro

Código	Ref.	U/Vta	U/Emb
15302797	91213	1	80

• 80 fundas - negro

Código	Ref.	U/Vta	U/Emb
15302798	91214	1	60



Dosier fástener A4 PVC mate

Código	Ref.	Color	U/Vta	U/Emb
18001874	91151	Amarillo	12	720
18001876	91153	Azul	12	720
18001873	91150	Gris	12	720
18001872	91149	Negro	12	720
18001875	91152	Verde	12	720



Dosier sobre A4 polipropileno con broche

• Traslúcido

Código	Ref.	Color	U/Vta	U/Emb
18001880	91172	Amarillo	12	600
18001877	91169	Azul	12	600
18001881	91173	Incoloro	12	600
18001879	91171	Rojo	12	600
18001878	91170	Verde	12	600

• Opaco

Código	Ref.	Color	U/Vta	U/Emb
18001882	91174	Azul	12	600
18001884	91176	Rojo	12	600
18001883	91175	Verde	12	600



Bolígrafo One

Código	Ref.	Color	U/Vta	U/Emb
10101407	91541	Azul	50	2000
10101408	91542	Negro	50	2000
10101409	91543	Rojo	50	2000

Bolígrafo gel Office 0,5mm

Código	Ref.	Color	U/Vta	U/Emb
11201204	91533	Azul	12	1728
11201205	91534	Negro	12	1728
11201206	91535	Rojo	12	1728

Roller Needle Tip 0,5 azul

Código	Ref.	U/Vta	U/Emb
11201279	91552	50	500



Lápiz de grafito Hexa HB con goma

Código	Ref.	U/Vta	U/Emb
12802399	91555	12	2880



Lápiz de grafito HB triangular con goma

Código	Ref.	U/Vta	U/Emb
12802481	91558	12	2880



Goma de borrar Synthetic

Código	Ref.	U/Vta	U/Emb
11101362	91296	40	800



Goma de borrar Synthetic Duo

Código	Ref.	U/Vta	U/Emb
11101363	91299	40	800



Afilalápiz metálico cuña

Código	Ref.	U/Vta	U/Emb
13701251	91518	24	2880



Afilalápiz Pocket con depósito Colores surtidos

Código	Ref.	U/Vta	U/Emb
13701254	91529	72	2880



Afilalápiz doble con depósito Colores surtidos

Código	Ref.	U/Vta	U/Emb
13701253	91528	12	720



Afilalápiz mecánico sobremesa

Código	Ref.	U/Vta	U/Emb
13701252	91526	1	72



Portaminas Delta 0,5mm

Código	Ref.	U/Vta	U/Emb
12501142	91560	12	1728



Portaminas Alfa 0,5mm

Código	Ref.	U/Vta	U/Emb
12501143	91561	12	1728



Portaminas Beta 0,7mm

Código	Ref.	U/Vta	U/Emb
12501144	91562	12	1728



Minas Graphite HB Tubo de 12

Código	Ref.	Artículo	U/Vta	U/Emb
21901181	91570	0,5mm	1	2592
21901182	91571	0,7mm	1	2592



Corrector en cinta 5mm En blíster

Código	Ref.	Artículo	U/Vta	U/Emb
15101104	91417	6m	48	576
15101103	91416	8m	24	576
15101102	91415	15m	24	432



Corrector líquido bolígrafo 10ml

Código	Ref.	U/Vta	U/Emb
15101101	91055	12	576



Corrector líquido bolígrafo 7ml punta de metal

Código	Ref.	U/Vta	U/Emb
15101099	91050	12	576



Corrector líquido frasco 20ml

Código	Ref.	U/Vta	U/Emb
15101100	91051	12	240



Taco de notas blancas encolado 500 hojas 90 x 90mm

Código	Ref.	U/Vta	U/Emb
26901387	91030	1	60



Taco de notas sin encolar 800 hojas 85 x 85mm

Código	Ref.	Color	U/Vta	U/Emb
26901388	91033	Blanco	1	240
26901389	91034	5 colores pastel	1	240



Porta notas transparente 800 hojas 90 x 90mm

Código	Ref.	Color	U/Vta	U/Emb
24301164	91031	Blanco	1	32
24301165	91032	5 colores pastel	1	32



Borrador de pizarra madera

Código	Ref.	U/Vta	U/Emb
15101126	91259	1	240



Borrador de pizarra magnético

Código	Ref.	U/Vta	U/Emb
15101105	91258	1	144



Imanes redondos Colores surtidos

• Blíster de 8 - 30mm

Código	Ref.	U/Vta	U/Emb
24405194	91386	1	144

• Blíster de 4 - 40mm

Código	Ref.	U/Vta	U/Emb
24405193	91385	1	144



Chincheta 9,5mm Caja de 100

Código	Ref.	Artículo	U/Vta	U/Emb
12001034	91364	Niqueladas	10	250
12001033	91363	Colores	10	250



Aguja señalizadora Caja de 100

Código	Ref.	Artículo	U/Vta	U/Emb
12001031	91361	Redonda	10	250
12001032	91362	Push Pin	20	160



Grapadora Twenty 20h

Código	Ref.	Color	U/Vta	U/Emb
12901497	91673	Azul	1	96
12901496	91672	Gris	1	96
12901495	91671	Naranja	1	96

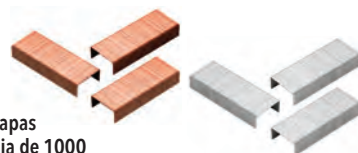

Grapas Caja de 1000

Código	Ref.	Artículo	U/Vta	U/Emb
12901510	91373	Cobreadas - Nº10	10	800
12901512	91375	Cobreadas - 24/6	10	800
12901509	91372	Galvanizadas - Nº10	10	800
12901511	91374	Galvanizadas - 24/6	10	800



Grapadora Cuqui 12h

Código	Ref.	Color	U/Vta	U/Emb
12901502	91678	Azul	1	288
12901503	91679	Rojo	1	288
12901501	91677	Verde	1	288



Extrae-grapas pinza 913 Colores surtidos

Código	Ref.	U/Vta	U/Emb
19001036	91377	1	480



Taladro 2 punzones Full Metal

Código	Ref.	Artículo	Color	U/Vta	U/Emb
13101201	91670	10 hojas	Azul	1	96
13101199	91669	10 hojas	Gris	1	96
13101188	91668	10 hojas	Naranja	1	96
13101187	91667	20 hojas	Azul	1	72
13101186	91666	20 hojas	Gris	1	72
13101185	91665	20 hojas	Naranja	1	72
13101184	91664	30 hojas	Azul	1	48
13101183	91663	30 hojas	Gris	1	48
13101182	91662	30 hojas	Naranja	1	48

Clip niquelado Caja de 100

Código	Ref.	Artículo	U/Vta	U/Emb
12101101	91340	Nº1,5 (25mm)	10	250
12101105	91353	Nº1,5 (28mm)	10	250
12101106	91354	Nº2 (33mm)	10	250
12101102	91341	Nº3 (43mm)	10	100
12101107	91355	Nº4 (50mm)	10	100



Clip niquelado especial ondulado

Código	Ref.	Artículo	Caja	U/Vta	U/Emb
12101108	91356	78mm	50 uds	10	100
12101103	91344	50mm	100 uds	10	100



Clip niquelado triangular Caja de 100

Código	Ref.	Artículo	U/Vta	U/Emb
12101109	91357	Nº1,5 (25mm)	10	250
12101110	91358	Nº2 (31mm)	10	250



Clip de colores Nº1,5 (28mm) Caja de 100

Código	Ref.	U/Vta	U/Emb
12101112	91360	10	250



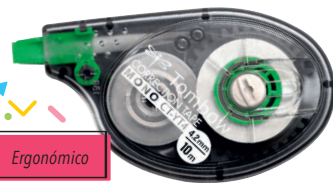

Ergonómico

Corrector en cinta MONO CT-YT4
Aplicación lateral - 4,2mm x 10m

Código	Ref.	Artículo	U/Vta	U/Emb
15103031	CT-YT4	Blistér	12	144
15103237	CT-YT4-20	Caja	20	20



Ultra Silencioso

Corrector en cinta MONO AIR compacto
Aplicación frontal - 4,2mm x 10m

Código	Ref.	U/Vta	U/Emb
15101078	CT-CA4-20	20	20



Pegamento líquido permanente
MONO Aqua 50ml Doble punta
Expositor de 10

Código	Ref.	U/Vta	U/Emb
23101199	PT-WTC-10P	1	10



Portagomas y recambio MONO Zero punta redonda 2,3mm

Código	Ref.	Artículo	U/Vta	U/Emb
11101280	EH-KUR	Cuerpo blanco/azul/negro	5	5
11101281	EH-KUR11	Cuerpo negro	5	5
25408179	ER-KUR	Recambio redondo	5	5



Portagomas y recambio MONO Zero punta rectangular 2,5 x 5mm

Código	Ref.	Artículo	U/Vta	U/Emb
11101282	EH-KUS	Cuerpo blanco/azul/negro	5	5
11101283	EH-KUS11	Cuerpo negro	5	5
25408178	ER-KUS	Recambio rectangular	5	5

Contenido:
6x punta redonda a rayas
6x punta redonda negro
6x punta rectangular a rayas
6x punta rectangular negro



Portagomas MONO Zero
Expositor surtido de 24

Código	Ref.	U/Vta	U/Emb
15101077	EH-KU-24P-A	1	1



Marcador MONO Twin doble punta
(Fina 0,4mm - Gruesa 0,8mm)
tinta opaca permanente

Secado sin tiempo de espera

Código	Ref.	Artículo	U/Vta	U/Emb
10203810	OS-TME15	Azul	10	10
10203809	OS-TME33	Negro	10	10
10203811	OS-TME25	Rojo	10	10



Marcador flúor Mono Edge doble
punta Estuche de 6

Código	Ref.	U/Vta	U/Emb
10202972	WA-TC-6P	1	12



Rotulador doble punta pincel
colores para retratos
Estuche de 12

Código	Ref.	U/Vta	U/Emb
10203626	ABT-12P-4	1	1



Rotulador doble punta pincel
Estuche de 12

Código	Ref.	Color	U/Vta	U/Emb
10202871	ABT-12P-1	Primarios	1	1
10202872	ABT-12P-2	Pastel	1	1
10202971	ABT-12P-3	Grises	1	1



Tinta base agua

Rotulador Twintone doble punta (fina y extrafina)
Estuche de 12

Código	Ref.	Color	U/Vta	U/Emb
10202974	WS-PK-12P-1	Brillantes	1	24
10202975	WS-PK-12P-2	Pastel	1	24
10202976	WS-PK-12P-3	Arco Iris	1	24



N
Nuevo modelo

Tinta base agua

Rotulador ABT Dual Brush doble punta pincel
Estuche de 6

Código	Ref.	Color	U/Vta	U/Emb
10203965	ABT-6C-1	Primarios	1	6
10202870	ABT-6C-2	Pastel	1	6
10202969	ABT-6C-4	Candy	1	6
10202970	ABT-6C-5	Vintage	1	6
10204809	ABT-6C-6	Grises	1	6



Rotulador Caligrafía Fudenosuke
punta dura

Código	Ref.	Estuche	U/Vta	U/Emb
10203362	WS-BH-6P	6 colores neón	1	12
10202966	WS-BH-10P	10 uds colores vivos	1	6



PARA PAPELES OSCUROS

Rotulador caligrafía Fudenosuke
punta blanda

Código	Ref.	U/Vta	U/Emb
10204974	WS-BS-6P	1	3



- 4x Rotulador ABT Dual Brush
- 1x Blender pen
- 1x Lápiz grafito
- 2x Rotulador caligrafía (duro y blando)
- 1x Rotulador permanente doble punta
- 1x goma
- 1x Manual instrucciones

Set Lettering Advanced
Blister de 10

Código	Ref.	U/Vta	U/Emb
10202874	LS-ADV	1	24



- 5x Rotulador ABT Dual Brush
- 1x Pincel Water Brush punta fina
- 1x Lápiz Grafito
- 1x Rotulador caligrafía punta dura
- 1x Goma
- 1x Paleta de mezclas
- 1x Manual instrucciones

Crea degradados de color

Set Blended Lettering
Blister de 10

Código	Ref.	Artículo	U/Vta	U/Emb
10203627	BS-FH1	Cozy Times	1	24
10203628	BS-FH2	Good Vives	1	24



- 2x Rotulador ABT Dual Brush
- 1x Lápiz grafito
- 1x Rotulador caligrafía
- 1x Rotulador permanente doble punta
- 1x goma
- 1x Manual instrucciones

Set Lettering Beginner
Blister de 6

Código	Ref.	U/Vta	U/Emb
10202873	LS-BEG	1	24



N
Novedad

- 4x Rotulador flúor
- 4x Rotulador doble punta
- 1x Bolígrafo 4 colores

Para que tus notas destaquen

Kit estudio creativo

Código	Ref.	U/Vta	U/Emb
10204975	STUD-SET	1	24



Cuaderno Lettering Letreando

Código	Ref.	Artículo	U/Vta	U/Emb
12601274	ADU2-003-2	Iniciación	1	5
12601275	ADU2-004-3	Perfeccionamiento	1	5



Pincel de agua Water Brush

Código	Ref.	Artículo	U/Vta	U/Emb
12301217	WB-FN-1P	Punta fina	6	6
12301218	WB-ME-1P	Punta media	6	6
12301219	WB-FL-1P	Punta plana	6	6
12301220	WB-3P	Blister de 3 surtido	6	6



Lápices de colores

Código	Ref.	Artículo	U/Vta	U/Emb
12801117	730/12	12 Uds.	12	240
12801118	730/24	24 Uds.	10	120
12801305	735/12	12 Uds. Triangular (Maxi)	10	80



**Lápices de madera
Caja surtida de 144**

Código	Ref.	U/Vta	U/Emb
12802039	739	1	6



Lápices de colores Woodless triangulares

Código	Ref.	Artículo	U/Vta	U/Emb
12802085	734/12	Estuche de 12	1	240
12802086	734/24	Estuche de 24	1	120
12802087	734/84	Estuche de 84	1	20
12802088	734/288	Class Pack de 288	1	4



Ceras plásticas Plasticolor formato cilíndrico

Código	Ref.	Artículo	U/Vta	U/Emb
16001122	926	Estuche de 24	5	20
16001120	913	Estuche de 12	5	50
16001186	929	Caja de 300	1	6



Jovicolor ceras de colores surtidos en formato cilíndrico

Código	Ref.	Artículo	U/Vta	U/Emb
16001026	980/12	12 uds	5	20
16001027	980/18	18 uds	5	20
16001047	980/24	24 uds	5	50
16001055	989	Caja de 300	1	6



Ceras Triwax ergonómicas triangulares

Código	Ref.	Artículo	U/Vta	U/Emb
16001188	973/12	12 uds	5	20
16001189	973/24	24 uds	5	20
16001277	979	Caja de 300	1	6



Ceras Large formato hexagonal

Código	Ref.	Artículo	U/Vta	U/Emb
16001021	912	12 Uds.	5	50
16001023	924	24 Uds.	5	50
16001045	909	Caja de 300	1	6



**Ceras Jovicolor
Bote de 60**

Código	Ref.	Artículo	U/Vta	U/Emb
16001527	980/60M	Multicultural	1	6
16001528	980/60P	Pastel	1	6



**Ceras Jovicolor Oso Mágico
Estuche de 8 colores básicos**

Código	Ref.	U/Vta	U/Emb
16001529	948	12	12



Afilalápiz plástico para ceras

Código	Ref.	U/Vta	U/Emb
13701038	49	25	300





Rotuladores

Código	Ref.	Artículo	U/Vta	U/Emb
10201079	1606	Estuche 6	10	80
10201080	1612	Estuche 12	10	40
10201082	1624	Estuche 24	10	20
10201227	1696	Bote de 96	1	6



Rotuladores Caja surtido 144

Código	Ref.	U/Vta	U/Emb
10201872	1699	1	6



Rotuladores Maxi

Código	Ref.	Artículo	U/Vta	U/Emb
10201286	1706	Estuche 6	10	80
10201022	1712	Estuche 12	10	40
10201465	1724	Estuche 24	10	20
10201697	1748	Bote de 48	1	6
10201873	1799	Caja de 96	1	6



Rotulador Doble Punta Estuche de 12

Código	Ref.	U/Vta	U/Emb
10201939	1512	10	40



Rotulador Glitter Estuche de 8

Código	Ref.	U/Vta	U/Emb
10202301	1608G	10	40



Rotulador Decor Textil Estuche de 12

Código	Ref.	U/Vta	U/Emb
10201108	1410	5	40



Rotulador fibra Decor Metalic blister de 2 (oro y plata)

Código	Ref.	U/Vta	U/Emb
10201226	1602M	1	20



Rotulador fibra Decor Metalic Estuche de 6

Código	Ref.	U/Vta	U/Emb
10201225	1606M	1	20



Rotulador fibra Decor Metalic Estuche de 24

Código	Ref.	U/Vta	U/Emb
10202908	1624M	1	16

- 3x Rosa
- 3x Malva
- 3x Azul
- 3x Verde
- 6x Plata
- 6x Oro



Rotulador Decor textil Caja de 48

Código	Ref.	U/Vta	U/Emb
10202863	1448T	1	16



Ceras Decor glass Caja de 6 surtidas

Código	Ref.	U/Vta	U/Emb
16001085	1906	1	12



Marcadores de Gel
Expositor de 20 surtidos

Código	Ref.	U/Vta	U/Emb
16001434	1829	1	12

Marcadores de Gel

• Estuche de 12

Código	Ref.	Color	U/Vta	U/Emb
16001436	1815	Naranja	1	8
16001437	1816	Rosa	1	8
16001438	1817	Amarillo	1	8
16001439	1818	Verde	1	8

• Estuche de 4 surtidos

Código	Ref.	U/Vta	U/Emb
16001435	1810	1	12



Pasta de papel Patmaché 680g

Código	Ref.	U/Vta	U/Emb
25201018	380	1	12



Pinceles planos

Código	Ref.	Artículo	U/Vta	U/Emb
12301074	8300	Nº 0	12	300
12301075	8302	Nº 2	12	300
12301076	8304	Nº 4	12	300
12301077	8306	Nº 6	12	300
12301078	8308	Nº 8	12	300
12301079	8310	Nº 10	12	300
12301080	8312	Nº 12	12	300
12301081	8314	Nº 14	12	180
12301082	8316	Nº 16	12	180

Expositores pinceles

Código	Ref.	Artículo	U/Vta	U/Emb
12302008	8380	108 Surt.	1	1
12302007	8180	144 Surt.	1	1



Pinceles Redondos

Código	Ref.	Artículo	U/Vta	U/Emb
12301038	8199	Nº 00	12	300
12301039	8200	Nº 0	12	300
12301040	8201	Nº 1	12	300
12301041	8202	Nº 2	12	300
12301042	8203	Nº 3	12	300
12301043	8204	Nº 4	12	300
12301044	8205	Nº 5	12	300
12301045	8206	Nº 6	12	300
12301046	8207	Nº 7	12	300
12301047	8208	Nº 8	12	300
12301048	8209	Nº 9	12	300
12301049	8210	Nº 10	12	300
12301050	8211	Nº 11	12	300
12301051	8212	Nº 12	12	300



Pasta Modelar

• Blanca

Código	Ref.	Artículo	U/Vta	U/Emb
25201027	83	250 gr	6	24
25201028	85	500 gr	6	24
25201026	86	1000 gr	6	12

• Gris

Código	Ref.	Artículo	U/Vta	U/Emb
25201128	83G	250 gr	6	24
25201129	85G	500 gr	6	24
25201130	86G	1000 gr	6	12

• Terracota

Código	Ref.	Artículo	U/Vta	U/Emb
25201031	84	250 gr	6	24
25201030	88	500 gr	6	24
25201029	89	1000 gr	6	12

• Ocre

Código	Ref.	U/Vta	U/Emb
25201831	87	6	24



Tizas Classcolor

• Blancas

Código	Ref.	Artículo	U/Vta	U/Emb
27901010	1010	10 Uds.	1	160
27901013	1100	100 Uds.	1	16

• Color

Código	Ref.	Artículo	U/Vta	U/Emb
27901011	1020	10 Uds.	1	160
27901012	1120	100 Uds.	1	16



Tizas Maxi Color Classcolor

Código	Ref.	Artículo	U/Vta	U/Emb
27901053	1030	6 uds	1	12
27901054	1130	20 uds	1	12



Acuarelas - Pastillón 30mm

Código	Ref.	Artículo	U/Vta	U/Emb
13501020	830/12	12 uds	5	40
13501021	830/22	22 uds	5	20

Acuarelas de agua 22mm

Código	Ref.	Artículo	U/Vta	U/Emb
13501001	800/6	6 uds	5	50
13501002	800/12	12 uds	5	20
13501004	800/18	18 uds	5	50
13501005	800/24	24 uds	5	20



Témpera líquida 500 ml. (botella)

Código	Ref.	Artículo	U/Vta	U/Emb
27401007	50602	Amarillo	1	12
27401086	50621	Azul Cyan	1	12
27401087	50624	Azul Ultra	1	12
27401008	50607	Bermellón	1	12
27401005	50601	Blanco	1	12
27401013	50608	Magenta	1	12
27401083	50612	Marrón	1	12
27401106	50606	Naranja	1	12
27401088	50630	Negro	1	12
27401140	50638	Oro	1	12
27401139	50637	Plata	1	12
27401084	50617	Verde Medio	1	12
27401282	50609	Carne	1	12
27401085	50619	Verde Oscuro	1	12
27401186	50623	Violeta	1	12

Témpera líquida 250 ml. (botella)

Código	Ref.	Artículo	U/Vta	U/Emb
27401288	50202	Amarillo	1	12
27401296	50221	Azul Cyan	1	12
27401298	50224	Azul Ultramar	1	12
27401290	50207	Bermellón	1	12
27401287	50201	Blanco	1	12
27401292	50209	Carne	1	12
27401291	50208	Magenta	1	12
27401293	50212	Marrón	1	12
27401289	50206	Naranja	1	12
27401299	50230	Negro	1	12
27401564	50237	Plata	1	12
27401565	50238	Oro	1	12
27401294	50217	Verde Medio	1	12
27401295	50219	Verde Oscuro	1	12
27401297	50223	Violeta	1	12

Témpera líquida 1000 ml. (botella)

Código	Ref.	Artículo	U/Vta	U/Emb
27401113	51102	Amarillo	1	6
27401122	51121	Azul Cyan	1	6
27401120	51124	Azul Ultra	1	6
27401115	51107	Bermellón	1	6
27401112	51101	Blanco	1	6
27401116	51108	Magenta	1	6
27401117	51112	Marrón	1	6
27401114	51106	Naranja	1	6
27401121	51130	Negro	1	6
27401118	51117	Verde Medio	1	6
27401119	51119	Verde Oscuro	1	6
27401123	51123	Violeta	1	6



Témpera Glitter 250 ml. (botella)

Código	Ref.	Artículo	U/Vta	U/Emb
27401180	51702	Amarillo	1	12
27401184	51721	Azul	1	12
27401182	51708	Rosa	1	12
27401284	51738	Oro	1	12
27401283	51737	Plata	1	12
27401183	51717	Verde	1	12

Témpera líquida Fosforescente 250 ml.

Código	Ref.	Artículo	U/Vta	U/Emb
27401223	51902	Amarillo	1	12
27401225	51908	Magenta	1	12
27401224	51906	Naranja	1	12
27401226	51917	Verde medio	1	12

Témpera líquida 250ml (botella)
Caja de 6 (colores multicultural)

Código	Ref.	U/Vta	U/Emb
27401797	502/6M	1	1



**Pintura Latex Decor 55ml en bote
Caja de 6 surtidos**

Código	Ref.	U/Vta	U/Emb
23501038	670	1	10



**Pintura plástica para múltiples superficies
Decor 250ml**

Código	Ref.	Artículo	U/Vta	U/Emb
23501061	68002	Amarillo	1	12
23501068	68021	Azul cyan	1	12
23501070	68024	Azul ultramar	1	12
23501065	68007	Bermellón	1	12
23501060	68001	Blanco	1	12
23501063	68008	Magenta	1	12
23501066	68012	Marrón	1	12
23501062	68006	Naranja	1	12
23501071	68030	Negro	1	12
23501064	68017	Verde medio	1	12
23501067	68019	Verde oscuro	1	12
23501069	68023	Violeta	1	12
23501156	68037	Plata	1	12
23501157	68038	Oro	1	12



Tempera bote 35ml

Código	Ref.	Artículo	U/Vta	U/Emb
27401023	50302	Amarillo limón	5	100
27401021	50321	Azul cyan	5	100
27401031	50324	Azul ultra	5	100
27401022	50307	Bermellón	5	100
27401003	50301	Blanco	5	100
27401321	50309	Carne	5	100
27401028	50308	Magenta	5	100
27401030	50312	Marrón	5	100
27401026	50306	Naranja	5	100
27401033	50330	Negro	5	100
27401024	50317	Verde medio	5	100
27401029	50319	Verde oscuro	5	100
27401320	50323	Violeta	5	100
27401538	50337	Plata	5	100
27401539	50338	Oro	5	100
27401009	505	5 botes surtidos	1	20
27401010	507	7 botes surtidos	1	10
27401011	512	12 botes surtidos	1	10



**Tempera escolar
Botes de 15 ml**

Código	Ref.	Artículo	U/Vta	U/Emb
27401221	520	Caja de 6	1	24
27401222	521	Caja de 12	1	20



**Tempera bote 35ml
Expositor de 100 uds**

Código	Ref.	U/Vta	U/Emb
27401531	510E/100	1	1



**Tempera Gouache pastel 15ml + pincel
Estuche de 6**

Código	Ref.	U/Vta	U/Emb
27401669	520P	12	6



**Tempera Gouache pastel 35ml
Estuche de 6**

Código	Ref.	U/Vta	U/Emb
27401668	507P	6	6



Tempera Líquida Fosforescente 55 ml.

Código	Ref.	Artículo	U/Vta	U/Emb
27401203	504	4 colores surt.	1	10



Tempera Glitter 55 ml.

Código	Ref.	Artículo	U/Vta	U/Emb
27401188	518	6 botes + pincel	1	10



Pintura de dedos de colores

• 125ml

Código	Ref.	Artículo	U/Vta	U/Emb
23501012	56003	Amarillo	5	50
23501011	56021	Azul	5	50
23501013	56001	Blanco	5	50
23501000	56012	Marrón	5	50
23501075	56006	Naranja	5	50
23501014	56030	Negro	5	50
23501009	56007	Rojo	5	50
23501010	56017	Verde	5	50
23501218	56023	Violeta	5	50
23501144	56008	Magenta	5	50

• 500ml

Código	Ref.	Artículo	U/Vta	U/Emb
23501006	56103	Amarillo	1	12
23501005	56121	Azul	1	12
23501007	56101	Blanco	1	12
23501001	56112	Marrón	1	12
23501076	56106	Naranja	1	12
23501008	56130	Negro	1	12
23501003	56107	Rojo	1	12
23501004	56117	Verde	1	12
23501272	56123	Violeta	1	12
23501145	56108	Magenta	1	12

Pintura de dedos en bote

Código	Ref.	Bote	Estuche	U/Vta	U/Emb
23501015	540	35 ml	5 uds	1	20
23501002	560S	125 ml	6 uds	1	10



**Pintura de dedos 35ml
Estuche de 6**

Código	Ref.	Color	U/Vta	U/Emb
23501827	540B	Vivos	1	154
23501734	540P	Pastel	6	6



**Pintura Dedos
Set con esponjas y plantillas**

Código	Ref.	U/Vta	U/Emb
23501200	566	1	4

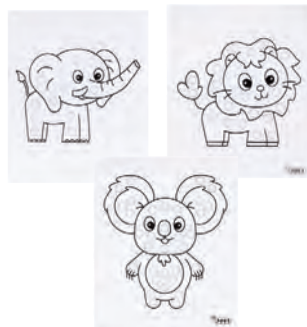

**Pintura de dedos 35ml
Súper Bucket de 5 botes + accesorios**

Código	Ref.	U/Vta	U/Emb
23501829	14FP	4	72



**Pintura de dedos 35ml
Súper Kit de 4 botes pastel + accesorios**

Código	Ref.	U/Vta	U/Emb
23501830	153FP	4	84





Delantal para niños

Código	Ref.	Tipo	U/Vta	U/Emb
25208158	103	Pre-escolar	5	25
25208159	104	Infantil	5	25



Bote Antivuelco para témpera, pintura plástica y pintura de dedos

Código	Ref.	U/Vta	U/Emb
25208014	125/30	30	30



Espátulas de moldear en blíster

Código	Ref.	Artículo	U/Vta	U/Emb
22101000	9	3 Espátulas surtidas	5	20
22101001	5	5 Modelos de espátulas	5	20



Pinceles tamaños 0/4/6/8/12 Blíster de 5

Código	Ref.	U/Vta	U/Emb
12301053	8185	1	12



Pinceles Blíster de 1 pincel mediano y 1 grueso

Código	Ref.	U/Vta	U/Emb
12301052	8184	1	12



Pinceles Antigoteo

Código	Ref.	Artículo	U/Vta	U/Emb
12301028	807	Gruesos 9 Uds.	1	40
12301027	806	Medio 20 Uds.	1	40



Tijera para plastilina

Código	Ref.	U/Vta	U/Emb
25201374	428	1	25



Juegos de modelaje en maletín Rodillo + moldeadores + plastilina

Código	Ref.	U/Vta	U/Emb
22101008	230	1	10



Accesorios de modelaje Bolsa de 12 moldes + rodillo

Código	Ref.	U/Vta	U/Emb
22101010	7/6R	1	25



Rodillo para manualidades Blíster de 1

Código	Ref.	U/Vta	U/Emb
24101475	155R	12	12

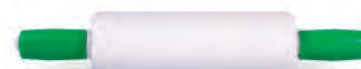

Rodillo de manualidades

Código	Ref.	U/Vta	U/Emb
22101015	155R/25	25	25



Musgueras para prensa para Blandiver Bolsa de 4

Código	Ref.	U/Vta	U/Emb
22101024	424	1	20



Cortadores rueda para la pasta de modelar

Código	Ref.	U/Vta	U/Emb
22101026	422	1	25



Moldes
Bolsa de 96

Código	Ref.	U/Vta	U/Emb
24101474	7/96	4	4

Accesorios de modelaje
Cubo de 24 moldes surtidos

Código	Ref.	U/Vta	U/Emb
22101009	7/24	1	4



Pinceles de goma grandes
Bolsa de 4

Código	Ref.	U/Vta	U/Emb
25201048	815	1	25



Rodillos con formas surtidas
Bolsa de 4

Código	Ref.	U/Vta	U/Emb
22101027	426	10	25



Espojas manualidades
Bolsa de 16

Código	Ref.	U/Vta	U/Emb
25208024	4/16	5	25



Pinceles Espuma

Código	Ref.	Artículo	U/Vta	U/Emb
25201047	814	3 Grandes	1	25
25201046	813	3 Pequeños	1	25



Rodillos de espuma para pintura

Código	Ref.	Artículo	U/Vta	U/Emb
25201044	811	3 Modelos pequeños formas diversas	1	25
25201043	810	Grande 1 pieza	1	25
25201045	812	Pequeños 3 modelos	1	25



Accesorios de modelaje en bolsa

Código	Ref.	Artículo	U/Vta	U/Emb
25208084	21	8 Formas geométricas	5	20
22101021	7A	Bolsa abecedario	1	20
22101022	7N	Números	5	20



Moldes de Frutas
Bolsa de 6 unidades

Código	Ref.	U/Vta	U/Emb
24120004	7F	1	25



Moldes Verduras
Bolsa de 6 unidades

Código	Ref.	U/Vta	U/Emb
24120003	7V	1	25



Moldes de Animales de la granja
Bolsa de 6 unidades

Código	Ref.	U/Vta	U/Emb
24120002	7G	1	25



Moldes Animales de la jungla
Bolsa de 6 unidades

Código	Ref.	U/Vta	U/Emb
24120001	7J	1	25



Plastilina Blandiver Juego "Mis primeras letras y números"

Código	Ref.	U/Vta	U/Emb
24101554	474	1	4

Soft Dough
BLANDIVER®



Plastilina Blandiver Juego "Animales"

Código	Ref.	U/Vta	U/Emb
24101553	475	1	4



Plastilina Blandiver Juego "Frutas y verduras"

Código	Ref.	U/Vta	U/Emb
24101555	476	1	4



Juegos de Plastilina Blandiver Cubo

Código	Ref.	U/Vta	U/Emb
24102009	444	1	4



Juegos de plastilina 6 pastillas + 3 moldeadores + 3 moldes + 1 mantel

Código	Ref.	Artículo	U/Vta	U/Emb
24101121	14	Cubo redondo	1	4



Plastilina 70 unicolor pastilla 50g
Caja de 30

Código	Ref.	Artículo	U/Vta	U/Emb
24101038	7002	Amarillo claro	1	6
24101040	7012	Azul claro	1	6
24101070	7013	Azul oscuro	1	6
24101037	7001	Blanco	1	6
24101035	7008	Carne	1	6
24101071	7014	Lila	1	6
24101017	7009	Marrón	1	6
24101032	7004	Naranja	1	6
24101033	7015	Negro	1	6
24101043	7005	Roja	1	6
24101034	7007	Rosa	1	6
24101036	7010	Verde claro	1	6
24101045	7011	Verde oscuro	1	6



Plastilina 71 pastilla 150g
Caja de 15

Código	Ref.	Artículo	U/Vta	U/Emb
24101026	7102	Amarillo claro	1	4
24101027	7103	Amarillo oscuro	1	4
24101025	7112	Azul claro	1	4
24101030	7113	Azul oscuro	1	4
24101023	7101	Blanca	1	4
24101021	7108	Carne	1	4
24101031	7114	Lila	1	4
24101016	7109	Marrón	1	4
24101018	7104	Naranja	1	4
24101019	7115	Negro	1	4
24101024	7105	Roja	1	4
24101020	7107	Rosa	1	4
24101028	7106	Rubí	1	4
24101022	7110	Verde claro	1	4
24101029	7111	Verde oscuro	1	4
24101001	71S	Colores surtidos	1	4
24101122	71B	Colores básicos	1	4



Plastilina 72 pastilla 350g
Caja de 15

Código	Ref.	Artículo	U/Vta	U/Emb
24101000	72S	Colores surtidos	1	1
24101127	72B	Colores básico	1	1
24101052	7202	Amarillo claro	1	1
24101084	7203	Amarillo oscuro	1	1
24101049	7212	Azul claro	1	1
24101063	7213	Azul oscuro	1	1
24101054	7201	Blanca	1	1
24101064	7208	Carne	1	1
24101065	7214	Lila	1	1
24101066	7209	Marrón	1	1
24101053	7204	Naranja	1	1
24101067	7215	Negra	1	1
24101051	7205	Rojo	1	1
24101015	7207	Rosa	1	1
24101068	7206	Rubí	1	1
24101050	7210	Verde claro	1	1
24101069	7211	Verde oscuro	1	1



Plastilina cilíndrica 90 15g
Colores surtidos

Código	Ref.	Estuche	U/Vta	U/Emb
24101005	90/6	6 barras	1	50
24101006	90/10	10 barras	1	30
24101007	90/15	15 barras	1	30



PLASTILINA

neon



Plastilina 90 neón, barra 15gr
Estuche de 6

Código	Ref.	U/Vta	U/Emb
24101423	90/6F	1	1

PASTEL



Plastilina 90 pastel en barra de 15g
Estuche de 6 surtidos.

Código	Ref.	U/Vta	U/Emb
24101408	90/6P	1	50



Plastilina 70 pastel pastilla de 50g
Caja de 6 surtidos.

Código	Ref.	U/Vta	U/Emb
24101409	70/6P	1	15



PASTEL



Plastilina 70 50gr
Caja de 30

Código	Ref.	Ref.	U/Vta	U/Emb
24101002	70S	15 colores surtidos	1	6
24101126	70B	6 colores básicos	1	6
24101421	70P	6 colores pastel	1	1



Plastilina 70 pastilla 50g
Expositor surtido de 180 uds

Código	Ref.	Ref.	U/Vta	U/Emb
24101400	70E/180	Col. Vivos	1	1
24101422	70E/180P	Col. Pastel	1	1



Plastilina surtida
Expositor de 54

Código	Ref.	U/Vta	U/Emb
24101455	D04002	1	25

8x Pastillas de plastilina 50g
1x Marco
3x Moldeadores
1x Rodillo + Láminas



Kit Pintar con plastilina
Expositor de 6

• Cool Candy

Código	Ref.	U/Vta	U/Emb
24101442	26302	1	4



• Crazy Monsters

Código	Ref.	U/Vta	U/Emb
24101444	26304	1	4



• Funny Emojis

Código	Ref.	U/Vta	U/Emb
24101443	26303	1	4



2x Kits Cool Candy
2x Kits Funny Emojis
2x Kits Crazy Monsters

Kit Pintar con plastilina
Expositor surtido de 6

Código	Ref.	U/Vta	U/Emb
24101441	26301	1	4



Plastilina 70 50gr
Kit de 3 pastillas + accesorios

Código	Ref.	U/Vta	U/Emb
24101471	153	1	84



6x Pastillas de plastilina 50g
2x Barritas de plastilina 15g
3x Moldeadores
2x Ruedas Crazy Cars
1x Plataforma Crazy Cars



Plastilina Jovitech
Kit Crazy Cars

• Racing

Código	Ref.	U/Vta	U/Emb
24101476	JT101	3	48



• Fantasy

Código	Ref.	U/Vta	U/Emb
24101477	JT102	3	48



• Monsters

Código	Ref.	U/Vta	U/Emb
24101478	JT103	3	48





Plastilina Soft Dough Blandiver 110g colores surtidos

Soft Dough BLANDIVER

Código	Ref.	Artículo	U/Vta	U/Emb
24102006	405	Pack de 5	1	10
24101558	410S	Pack de 10	1	5



Soft Dough Blandiver Botes individuales

• 110g

Código	Ref.	Artículo	U/Vta	U/Emb
24101074	45002	Amarillo	5	50
24101075	45005	Azul	5	50
24101076	45003	Rojo	5	50
24101077	45001	Blanco	5	50
24101078	45004	Verde	5	50
24101073	45006	Violeta	5	50
24101520	45007	Naranja	5	50
24101560	45008	Rosa	5	50
24101561	45009	Marrón	5	50
24101562	45010	Negro	5	50



• 460g

Código	Ref.	Artículo	U/Vta	U/Emb
24101079	46002	Amarillo	1	12
24101080	46005	Azul	1	12
24101081	46001	Blanco	1	12
24101116	46003	Rojo	1	12
24101115	46004	Verde	1	12
24101082	46006	Violeta	1	12
24101521	46007	Naranja	1	12
24101563	46008	Rosa	1	12
24101564	46009	Marrón	1	12
24101565	46010	Negro	1	12



Maquillaje Face Paint 8ml Expositor de 24 (4uds x 6 colores)

Código	Ref.	U/Vta	U/Emb
30001282	171D	1	20



Maquillaje Face Paint Set de 8ml + accesorios

Código	Ref.	Artículo	U/Vta	U/Emb
30001263	174FA	Fantasy	1	12
30001264	174AD	Adventure	1	12
30001265	174SC	Scary	1	12
30001266	174AN	Animals	1	12



Maquillaje en barra 5,6g

Código	Ref.	Artículo	U/Vta	U/Emb
30004058	175	Caja de 5 surt.	1	60
30004059	176	Caja 10 surt.	1	30



Maquillaje crema Face Paint 8ml Caja de 6 botes

Código	Ref.	U/Vta	U/Emb
30001166	171	1	20



Pinceles de maquillaje Bolsa de 3: plano + fino + redondo

Código	Ref.	U/Vta	U/Emb
30001204	17903BR	1	25



Taladro Goma EVA 1,6 cm

• 1,6 cm

Código	Ref.	Modelo	U/Vta	U/Emb
25208812	00038051	Árbol	1	24
25208813	00038151	Nieve	1	24
25208814	00038251	Círculo	1	24
25208815	00038351	Corona	1	24
25208816	00038451	Tulipán	1	24
25208817	00038551	Estrella	1	24
25208818	00038651	Corazón	1	24
25208819	00038751	Mariposa	1	24
25208820	00038851	Oso	1	24
25208821	00038951	Flor	1	24
25208822	00060051	Triángulo	1	24
25208823	00060151	Manzana	1	24
25208824	00060251	Conejo	1	24
25208825	00060351	Hoja	1	24
25208826	00060451	Cuadrado	1	24
25208827	00060751	Sol	1	24
25208828	00060851	Lazo	1	24
25208829	00060951	Mano	1	24



• 2,5 cm

Código	Ref.	Modelo	U/Vta	U/Emb
25208830	00062051	Estrella	1	16
25208831	00062151	Corazón	1	16
25208832	00062251	Corona	1	16
25208833	00062351	Flor	1	16
25208834	00062451	Oso	1	16
25208835	00062551	Copo nieve	1	16
25208836	00062651	Círculo	1	16
25208837	00062751	Mariposa	1	16
25208838	00062851	Tulipán	1	16
25208839	00062951	Manzana	1	16
25208840	00063051	Hoja	1	16
25208841	00063151	Cuadrado	1	16
25201224	00063451	Árbol	1	16
25201225	00063551	Lazo	1	16
25201226	00063651	Sol	1	16

• 3,8 cm

Código	Ref.	Modelo	U/Vta	U/Emb
25208842	00064051	Círculo	1	16
25208843	00064151	Estrella	1	16
25208844	00064251	Corazón	1	16
25208845	00064351	Flor	1	16
25208846	00064451	Mariposa	1	16
25201227	00066051	Árbol	1	16
25201228	00064851	Oso	1	16
25201229	00064751	Tulipán	1	16
25201230	00064651	Hoja	1	16
25201231	00064551	Copo nieve	1	16
25201232	00064951	Corona	1	16

• 5 cm

Código	Ref.	Modelo	U/Vta	U/Emb
25208847	00065051	Tulipán	1	4
25208848	00065151	Estrella	1	4
25208849	00065251	Mariposa	1	4
25208850	00065351	Flor	1	4
25208851	00065451	Corazón	1	4
25201233	00065851	Árbol	1	4
25201234	00065551	Círculo	1	4
25201235	00065651	Copo nieve	1	4
25201236	00065751	Corona	1	4
25201237	00065951	Hoja	1	4

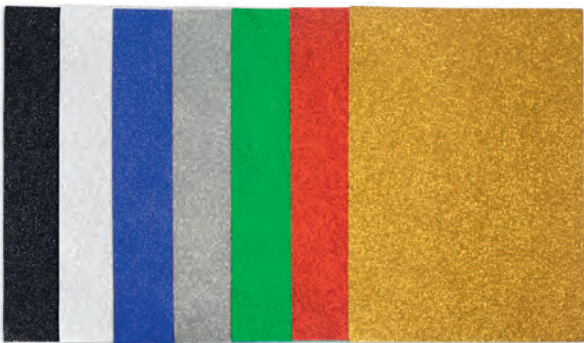

Goma Eva Hoja purpurina Paquete de 5

• 40 x 60cm

Código	Referencia	Color	U/Vta	U/Emb
25208555	68000220	Verde	1	20
25208556	68000230	Azul	1	20
25208557	68000251	Rojo	1	20
25208558	68000265	Oro	1	20
25208559	68000275	Plata	1	20
25201169	68000210	Negro	1	20

• 22 x 30cm

Código	Referencia	Color	U/Vta	U/Emb
25208561	68000320	Verde	1	80
25208562	68000330	Azul	1	80
25208563	68000351	Rojo	1	80
25208564	68000365	Oro	1	80
25208565	68000375	Plata	1	80



Goma Eva adhesiva

Código	Referencia	Motivo / Pack	U/Vta	U/Emb
25208569	68001100	Letras y números Pack 170 Figuras	1	24
25208570	68001200	Corazones Pack 90 Figuras	1	24
25208572	68001400	Formas con Relieve Pack 72 Figuras	1	24
25208575	68001700	Flores Pack 200 Figuras	1	24



Figuras de fieltro

Código	Referencia	Motivo	U/Vta	U/Emb
25208598	68003800	Corazones Pack de 30	1	24
25208599	68003900	Letras Pack de 100	1	24
25208601	68004100	Flores Pack de 30	1	24



Goma Eva adhesiva con purpurina

Código	Referencia	Motivo / Pack	U/Vta	U/Emb
25208579	68002100	Flores Pack 58 Figuras	1	24
25208580	68002200	Flores Y Corazones Pack 64 Figuras	1	24
25208582	68002400	Letras Pack 78 Figuras	1	24
25208583	68002500	Corazones Pack 59 Figuras	1	24



Cartulina Purpurina 50x65 cm 250g Paquete de 5



Código	Referencia	Color	U/Vta	U/Emb
10705002	68000720	Verde	1	20
10705003	68000730	Azul	1	20
10705004	68000751	Rojo	1	20
10705005	68000765	Oro	1	20
10705006	68000775	Plata	1	20

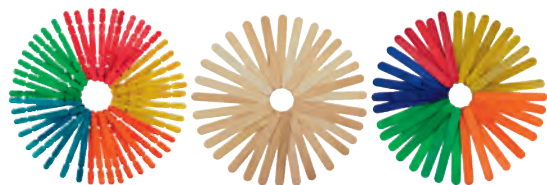

Palillos madera

Código	Referencia	Forma / Color	U/Vta	U/Emb
25208678	68005000	Planos Natural 15 Cm. Pack de 50	1	100
25208607	68005100	Planos Colores 15 Cm. Pack de 50	1	100
25208608	68005200	Planos Natural Finos 11,4 Cm. Pack de 50	1	150
25208609	68005300	Planos Colores Finos 11,4 Cm. Pack de 50	1	150
25208612	68005600	Redondos Natural 20 Cm. Pack de 36	1	150



Pinzas madera Pack de 30

Código	Referencia	Artículo	U/Vta	U/Emb
25208613	68005800	Natural	1	50
25208614	68005900	Colores	1	150



Ojos móviles negros

• Redondos

Código	Referencia	Tamaño / Pack	U/Vta	U/Emb
25208623	68009800	4 mm. Pack de 100	1	50
25208624	68009900	6 mm. Pack de 90	1	50
25208625	68010000	8 mm. Pack de 70	1	50
25208626	68010100	10 mm. Pack de 50	1	50
25208627	68010200	12 mm. Pack de 40	1	50
25208628	68010300	15 mm. Pack de 30	1	50
25208629	68010400	18 mm. Pack de 20	1	100

• Ovalados

Código	Referencia	Tamaño / Pack	U/Vta	U/Emb
25208630	68010500	6mm Pack de 80	1	100
25208631	68010600	8mm Pack de 60	1	100
25208632	68010700	10mm Pack de 40	1	100
25208633	68010800	12mm Pack de 35	1	50
25208634	68010900	14mm Pack de 30	1	100
25208635	68011000	20mm Pack de 20	1	100



Gomas elásticas Surtido 5 Gr.

Código	Referencia	U/Vta	U/Emb
25208673	68015000	1	500



Aros poliespán

Código	Referencia	Tamaño / Pack	U/Vta	U/Emb
25210022	68008800	10 cm. Pack de 1	1	50
25210023	68008900	12 cm. Pack de 1	1	50
25210024	68009000	16 cm. Pack de 1	1	50
25210025	68009100	28 cm. Pack de 1	1	50



Huevos poliespán

Código	Referencia	Tamaño / Pack	U/Vta	U/Emb
25210014	68007900	7,5 cm. Pack de 6	1	50
25210015	68008000	9 cm. Pack de 3	1	50



Corazones poliespán

Código	Referencia	Tamaño / Pack	U/Vta	U/Emb
25210003	68006800	4,5 cm. Pack de 12	1	50
25210004	68006900	8 cm. Pack de 6	1	50
25210005	68007000	9,4 cm. Pack de 6	1	50
25210006	68007100	15 cm. Pack de 1	1	50
25210007	68007200	Doble 15/20 cm. Pack de 1	1	50

Conos poliespán

Código	Referencia	Descripción	U/Vta	U/Emb
25210026	68009200	10 cm. Pack de 3	1	50
25210027	68009300	15 cm. Pack de 3	1	50
25210028	68009400	20 cm. Pack de 1	1	50
25210029	68009500	25 cm. Pack de 1	1	50
25210030	68009600	40 cm. Pack de 1	1	50



Campanas poliespán

Código	Referencia	Tamaño / Pack	U/Vta	U/Emb
25210008	68007300	5 cm. Pack de 8	1	50
25210009	68007400	7 cm. Pack de 6	1	50
25210010	68007500	9 cm. Pack de 6	1	50



Bolas poliespán

Código	Referencia	Descripción	U/Vta	U/Emb
25210016	68008100	4,5cm. Pack de 10	1	50



Estrellas poliespán

Código	Referencia	Tamaño / Pack	U/Vta	U/Emb
25210011	68007600	7,5 cm. Pack de 6	1	50
25210012	68007700	10 cm. Pack de 6	1	50
25210013	68007800	20 cm. Pack de 3	1	50



Abalorios plástico

Código	Referencia	Motivo	U/Vta	U/Emb
25208602	68004200	Redondos Bolsa de 30g	1	24
25208603	68004300	Corazones Bolsa de 40g	1	24
25208605	68004500	Madera Bolsa de 20g	1	24

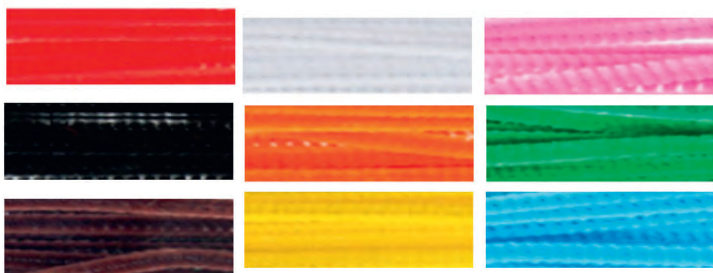

Varitas flexibles 30cm x 6 mm
Pack de 50

Código	Referencia	Color	U/Vta	U/Emb
25208656	68013100	Blanco	1	50
25208657	68013200	Rosa	1	50
25208658	68013300	Rojo	1	50
25208659	68013400	Naranja	1	50
25208660	68013500	Verde	1	50
25208661	68013600	Amarillo	1	50
25208662	68013700	Azul C.	1	50
25208663	68013800	Marrón	1	50
25208664	68013900	Negro	1	50



Pom Pom colores

Código	Referencia	Packs	U/Vta	U/Emb
25208652	68012700	Tamaños Surtidos Pack de 100	1	50
25208653	68012800	5 Cm. Surtidos Pack de 52	1	50
25208654	68012900	Brillantes Surtidos Pack de 100	1	50
25208655	68013000	Brillantes 5 cm. Surtidos Pack de 52	1	50



Esferas Night&Day con luz 25cm

Código	Ref.	U/Vta	U/Emb
18501042	0325GNNDSPBB	1	6

Esfera Corallo opaca 30cm

Código	Ref.	U/Vta	U/Emb
18501011	0330COPOSPONF	1	12



Esfera Arca con luz 25cm

Código	Ref.	U/Vta	U/Emb
18501041	0325ARACPLBB	1	6



Esferas Elite con luz

Código	Ref.	Tamaño	U/Vta	U/Emb
18501004	0325ELFGSPLBT	26 cm	1	12
18501005	0330ELFGSPLBT	30 cm	1	12



Esferas Marco Polo con Lupa y Luz

Código	Ref.	Tamaño	U/Vta	U/Emb
18501010	0325MPANSPLMF	26 cm	1	12
18501008	0330MPANSPLMF	30 cm	1	12



Esferas Camaleonte con luz 25cm

Código	Ref.	U/Vta	U/Emb
18501037	0325CACASPLW	1	6



Ceras de dedo
Estuche de 6

Código	Ref.	U/Vta	U/Emb
16001522	DA000700	1	12

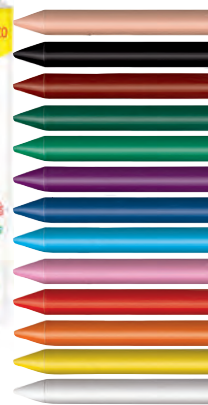

Ceras
Estuche de 12

Código	Ref.	U/Vta	U/Emb
16001325	DA000060	1	6



Ceras en barra
Estuche de 6

Código	Ref.	U/Vta	U/Emb
16001519	PX002006	6	48



Lápices de colores
Estuche de 12

Código	Ref.	U/Vta	U/Emb
12801570	AL000177	1	6



Rotulador de fibra
Estuche de 10

Código	Ref.	U/Vta	U/Emb
10203854	AR002010	1	12



Pintura de dedos bote de 40ml
Estuche de 6

Código	Ref.	U/Vta	U/Emb
23501790	DD002016	6	6



Ceras Plastialpino

Código	Ref.	Estuche	U/Vta	U/Emb
16001495	PA000012	12 uds	1	24
16001496	PA000024	24 uds	1	12

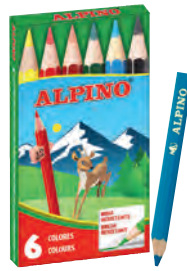

Lápices de colores cortos
Estuche de 6

Código	Ref.	U/Vta	U/Emb
12801090	AL010651	24	576



Lápices de colores largos

Código	Ref.	Estuche	U/Vta	U/Emb
12801078	AL010654	12 uds	1	144
12801077	AL010656	18 uds	1	96
12801076	AL010658	24 uds	1	72
12801901	AL010600	36 uds	1	24



Lápices de colores borrrable con goma
Estuche de 12

Código	Ref.	Estuche	U/Vta	U/Emb
12801953	AL013654	12 uds	1	144
12802095	AL013658	24 uds	12	72



Lápices Acuarelables Aqualine

Código	Ref.	Estuche	U/Vta	U/Emb
12801424	AL000130	12 uds	1	72
12801425	AL000131	24 uds	1	72



Lápices de colores largos
Expositor de 36 estuches

Código	Ref.	U/Vta	U/Emb
12802094	AL000903	1	1



Lápices de colores TRI

Código	Ref.	Estuche	U/Vta	U/Emb
12801282	AL000128	12 uds	1	12
12801283	AL000129	24 uds	1	72



Lápices Festival Classbox Economy Pack

Código	Ref.	Estuche	U/Vta	U/Emb
12801524	C0131144	132 + 12 gratis	1	6
12801831	C0131992	288 uds	1	6



Lápices de colores largos
Estuche metálico de 36

Código	Ref.	U/Vta	U/Emb
12801056	AL010760	1	32



Lápices de colores TRIMAX

Código	Ref.	Artículo	U/Vta	U/Emb
12801184	AL000113	Estuche de 12	1	25
12801495	AL000377	Classbox de 120	1	4



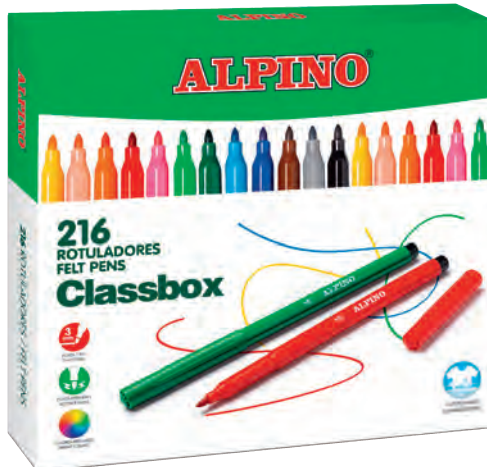

Rotulador Fibra Standard

Código	Ref.	Estuche	U/Vta	U/Emb
10201478	AR001001N	6 uds	1	288
10201479	AR001002N	12 uds	1	144
10201480	AR001003N	24 uds	1	72
10204423	AR001036N	36 uds	1	6
10201837	AR000108N	216 uds	1	6



Rotulador Fibra Maxi

Código	Ref.	Estuche	U/Vta	U/Emb
10201482	AR000006N	12 uds	1	144
10201483	AR000007N	24 uds	1	72
10201812	AR000109N	144 uds	1	6



Rotulador Fibra Double Double

Código	Ref.	Estuche	U/Vta	U/Emb
10201487	AR002013N	12 uds	1	24
10201519	AR002058N	24 uds	1	12



Rotulador fibra Standard Fluo Estuche de 8

Código	Ref.	U/Vta	U/Emb
10202862	AR001005	1	24

Rotulador fibra Standard Pastel Estuche de 6

Código	Ref.	U/Vta	U/Emb
10202861	AR001004	1	24



Rotulador fibra Color Experience Metallic Outliner Bolsa de 6

Código	Ref.	U/Vta	U/Emb
10204865	AR001044	1	12



Lápices de colores Experience

Código	Ref.	Estuche	U/Vta	U/Emb
12802242	AL000246	12 uds	1	12
12802241	AL000247	24 uds	1	12



Lápices de colores acuarelables Experience Estuche de metal de 36 unidades

Código	Ref.	U/Vta	U/Emb
12801917	AL000242	1	8



Lápices de colores Experience Mandala Caja de 24

Código	Ref.	U/Vta	U/Emb
12802296	AL000250	1	8

Incluye libro de 120 Mandalas



Rotulador fibra Kit Experience Bullet Journal Kit de 22

Código	Ref.	U/Vta	U/Emb
10203479	AR001010	1	8



Rotulador fibra Experience Hand lettering Kit de 30

Código	Ref.	U/Vta	U/Emb
10203526	AR000701	1	8

1x rotuladores súper pincel
1x rotulador punta fina 0,7mm
1x rotulador punta media 3,4mm
1x lápiz de grafito
1x goma
25x rotuladores punta pincel



Rotulador fibra Experience Dual Artist doble punta (fina/pincel)

Código	Ref.	Caja	U/Vta	U/Emb
10202134	AR000176	36 uds	1	8
10204796	AR000197	72 uds	1	8



Rotulador fibra Color Experience Caja de 36

Código	Ref.	U/Vta	U/Emb
10203820	AR001038	1	8



Rotulador de fibra Color Experience Lettering Estuche de 12

Código	Ref.	U/Vta	U/Emb
10204421	AR001054	1	12





Rotulador de fibra Color Experience Fineliner 0,4
Caja de 24

Código	Ref.	U/Vta	U/Emb
10203821	AR001039	1	12



Rotulador de fibra Color Callygraphy
doble punta (fina/pincel)
Estuche de 6

Código	Ref.	U/Vta	U/Emb
10203822	AR001040	1	12



Rotulador fibra Experience Dual Artist
doble punta (fina/pincel)

Código	Ref.	Estuche	U/Vta	U/Emb
10203477	AR000186	12 uds	1	12
10203478	AR000187	24 uds	1	12



Rotulador fibra Experience Dual Artist pastel
doble punta (fina/pincel)
Estuche de 12

Código	Ref.	U/Vta	U/Emb
10204864	AR000188	1	12



Rotulador de fibra Color Experience
Metallic Lettering
Set de 12

Código	Ref.	U/Vta	U/Emb
10204823	AR010701	1	4

12x Rotulador doble punta
1x Bloc lettering 20h
1x Guía de ideas



36x Acuarelas de colores
2x Pinceles
1x Esponja
1x Lápiz de grafito 2B
1x Goma
1x Sacapuntas
1x Set de papel acuarela

Acuarelas Color Experience
Set de 36

Código	Ref.	U/Vta	U/Emb
13501212	AQ001036	1	4



21x Pinturas acrílicas 3ml
1x Lienzo 40 x 30cm
3x Pinceles

Pintura acrílica Color Experience
"Pinta por números"
Estuche de 21

Código	Ref.	U/Vta	U/Emb
23501826	DV000721	1	6



Purpurina en cola
Blíster de 8 classic + 2 neón

Código	Ref.	U/Vta	U/Emb
23501282	DE000030	1	6



Purpurina en cola Classic
Blíster de 6

Código	Ref.	U/Vta	U/Emb
25901081	DE000015	1	12



Rotulador fibra Crea+ Glitter
Estuche de 6

Código	Ref.	U/Vta	U/Emb
10202494	AR000178	1	12



Pintura Cristal Crea+
Estuche de 12

Código	Ref.	U/Vta	U/Emb
23501221	DE000028	1	6



Pintura 3D Crea+
Estuche de 12

Código	Ref.	U/Vta	U/Emb
23501220	DH000005	1	6



Rotulador fibra Crea+ Metal
Estuche de 7

Código	Ref.	U/Vta	U/Emb
10201789	AR010134	1	6



Pintura textil Crea+ 20ml
Estuche de 6

Código	Ref.	U/Vta	U/Emb
10204422	DE000036	1	6



Rotulador Crea+ Textil
Estuche de 10

Código	Ref.	U/Vta	U/Emb
10201790	AR010132	1	6



Ceras Crea+ Textile Wax
Estuche de 12

Código	Ref.	U/Vta	U/Emb
16001367	PX000001	1	6





Plastilina Standard 50g
Caja de 24 unidades surtidas

Código	Ref.	U/Vta	U/Emb
24101113	DP000915	1	6



Plastilina Standard 150g
Caja de 12 unidades surtidas

Código	Ref.	U/Vta	U/Emb
24101114	DP000918	1	4



Kit Plastilina
6 colores + 6 moldes

Código	Ref.	U/Vta	U/Emb
24101428	DP000800	1	6



Kit Plastilina
7 colores + 7 herramientas + rodillo

Código	Ref.	U/Vta	U/Emb
24101120	DP000055	1	12



Juego para modelar, 4 botes de 25g
Expositor de 12

Código	Ref.	Artículo	U/Vta	U/Emb
25901809	DP000021	Cactus	1	1
25901810	DP000022	Ovni	1	1
25901811	DP000023	Dino	1	1



Pintura de dedos 40ml
Estuche de 5

Código	Ref.	U/Vta	U/Emb
23501789	DD020105	1	12



Témpera sólida Pintacolor

Código	Ref.	Estuche	U/Vta	U/Emb
27401421	PX000006	6 (col. flúor)	1	12
27401420	PX000012	12 uds	1	12



Témpera 40ml
Estuche de 5

Código	Ref.	U/Vta	U/Emb
27401745	DM020920	1	12



Témpera en bote de 40ml
Estuche de 7

Código	Ref.	U/Vta	U/Emb
27401746	DM020921	1	5



Acuarelas

Código	Ref.	Caja	U/Vta	U/Emb
13501186	AQ000008	8 uds	1	12
13501017	AQ000001	12 uds	1	12
13501018	AQ000002	21 uds	1	12
13501187	AQ000009	24 uds	1	6



Taladro 1 punzón Clipper Perforette
Expositor de 30 unidades surtidas

Código	Ref.	U/Vta	U/Emb
13101002	PF0005	1	1



Tijeras escolares para zurdos 13 cm
Caja de 12

Código	Ref.	U/Vta	U/Emb
27601133	PT0020	1	50



Tijeras Kaicut Escolar
Expositor de 25 unidades

Código	Ref.	U/Vta	U/Emb
27601006	PT0014	1	6



Tijera School Escolar
Expositor de 25 unidades

Código	Ref.	U/Vta	U/Emb
27601024	PT0013	1	6



Tijeras escolares Pastel
Expositor de 12

Código	Ref.	U/Vta	U/Emb
27601284	PT0051	1	6



Tijeras escolares Colorful
Expositor de 12

Código	Ref.	U/Vta	U/Emb
27601286	PT0061	1	6



Tijera Fashion Shapes 8+1
Cortes especiales

Código	Ref.	U/Vta	U/Emb
27601260	PT0030	1	6



Pizarra blanca en rollo Clipper
90 x 160cm

Código	Ref.	U/Vta	U/Emb
23801420	PP0603	1	24



Pizarra blanca Clipper

Código	Ref.	Color	U/Vta	U/Emb
23801349	PP0213	18 x 25,5cm	1	192
23801350	PP0215GS	25 x 35cm	1	192



Portatodo Colors doble cremallera

Código	Ref.	U/Vta	U/Emb
24304730	UA000139	1	4



Portatodo triple

Código	Ref.	Color	U/Vta	U/Emb
11301908	UA000162	Geometric	1	48
11301910	UA000164	Sports	1	48



Portatodo 1 cremallera

Código	Ref.	Color	U/Vta	U/Emb
11301907	UA000161	Geometric	1	48
11301909	UA000163	Sports	1	48



Plumier pequeño doble Colors

Código	Ref.	U/Vta	U/Emb
11301783	UA000113	1	4



Plumier mini Black

Código	Ref.	U/Vta	U/Emb
11302089	UA000165	1	4

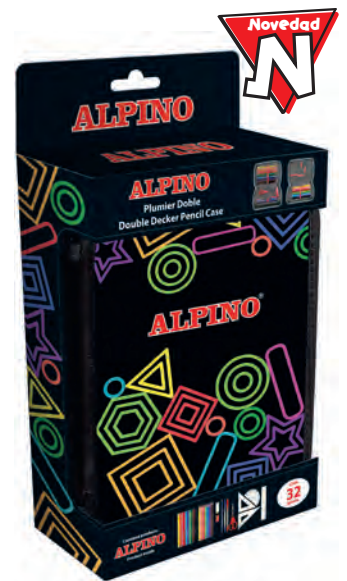

Plumier Color Black doble cremallera

Código	Ref.	U/Vta	U/Emb
11302088	UA000166	1	4



Portaminas Maxim 2mm Blister con minas

Código	Ref.	Artículo	U/Vta	U/Emb
12501158	PM050100	1300	1	60
24302052	PM035300	Metallic	1	60



Minas Maxim HB 2mm Caja de 12uds

Código	Ref.	U/Vta	U/Emb
21901033	PM000200	1	12



Portaminas Maxim 2mm Expositor de 24

Código	Ref.	Artículo	U/Vta	U/Emb
24302055	PM001300	1300	1	4
12501159	PM050110	Metallic	1	4





Lápiz de grafito Junior HB
Blister de 3

Código	Ref.	U/Vta	U/Emb
12802489	JU000033	1	25



Lápices Junior con cabecilla - HB

Código	Ref.	U/Vta	U/Emb
12801269	JU015012	12	288



Lápiz de grafito Junior
Blister de 6 + afila + goma

Código	Ref.	U/Vta	U/Emb
12801633	JU000016	1	25



Lápiz de grafito Junior Tri HB
Blister de 6 + afilagoma

Código	Ref.	U/Vta	U/Emb
12802490	JU000034	1	25



Lápiz de grafito Junior triangular.
Blister de 8 + 4

Código	Ref.	U/Vta	U/Emb
12801927	JU000013	1	25



Lápiz de grafito Junior con goma-HB
Blister de 8 + 4

Código	Ref.	U/Vta	U/Emb
12801632	JU000011	1	25



Lápices oficina Memorial bicolor
Caja de 12

Código	Ref.	U/Vta	U/Emb
12801074	LE004313	1	144



Blíster 2 lápices Memorial
incluye sacapuntas

Código	Ref.	U/Vta	U/Emb
12801725	LE000018	25	25

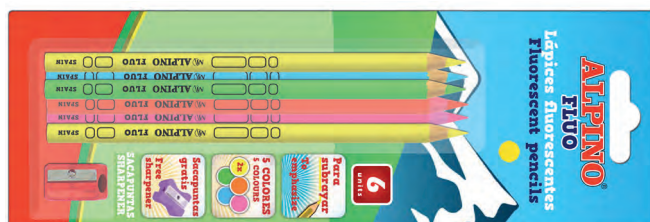

Lápiz Fluor
Blister 6 con afila

Código	Ref.	U/Vta	U/Emb
12801724	LE000019	1	25



Lápiz Carboncillo Carbonil

Código	Ref.	U/Vta	U/Emb
12801084	LE010012	12	144



Maquillaje glitter gel metálico
Blíster de 1

Código	Ref.	Color	U/Vta	U/Emb
30001270	DL000603	Azul	1	12
30001269	DL000602	Oro	1	12
30001268	DL000601	Plata	1	12
30001271	DL000604	Rosa	1	12



Maquillaje glitter gel
Blíster de 1

Código	Ref.	Color	U/Vta	U/Emb
30001273	DL000606	Oro	1	12
30001272	DL000605	Plata	1	12



24x Glitter gel metálico
12x Glitter gel



Maquillaje glitter gel
Expositor de 36

Código	Ref.	U/Vta	U/Emb
30001267	DL000600	1	4



Maquillaje 5g
Caja de 6 unidades

Código	Ref.	Color	U/Vta	U/Emb
30004052	DL000011	Sports	1	12
30004117	DL000112	Princess	1	12



Maquillaje Fiesta Liquid Make Up 8
colores x 10gr

Código	Ref.	U/Vta	U/Emb
30004118	DL000100	1	5



Maquillaje fiesta barra de 5 g face stick

Código	Ref.	Color	U/Vta	U/Emb
30004095	DL000086	Amarillo	6	120
30004098	DL000089	Azul	6	120
30001149	DL000056	Azul cian	6	120
30004094	DL000085	Blanco	6	120
30001150	DL000057	Marrón	6	120
30001146	DL000053	Naranja	6	120
30004099	DL000090	Negro	6	120
30004096	DL000087	Rojo	6	120
30001147	DL000054	Rosa	6	120
30004097	DL000088	Verde	6	120
30001148	DL000055	Violeta	6	120
30004088	DL000075	Epositor de 36	1	6



Maquillaje Face Stick
Blíster 6 uds

Código	Ref.	U/Vta	U/Emb
30004077	DL000014	1	12



Maquillaje Liquid liner de 6g
Caja de 4 unidades unicolor

Código	Ref.	Color	U/Vta	U/Emb
30001152	DL000201	Blanco	1	12
30001153	DL000202	Amarillo	1	12
30001154	DL000203	Naranja	1	12
30001155	DL000204	Rojo	1	12
30001156	DL000205	Rosa	1	12
30001157	DL000206	Violeta	1	12
30001158	DL000207	Azul	1	12
30001159	DL000208	Verde	1	12
30001160	DL000209	Marrón	1	12
30001161	DL000210	Negro	1	12
30001162	DL000211	Oro	1	12
30001163	DL000212	Plata	1	12
30001144	DL000200	Exp. 24 + 2 uds	1	4



Maquillaje sangre artificial 15ml

Código	Ref.	U/Vta	U/Emb
30001081	DL000164	1	12



Maquillaje cera FX deformaciones 15g

Código	Ref.	U/Vta	U/Emb
30001080	DL000163	1	12



Maquillaje efectos especiales FX

Código	Ref.	U/Vta	U/Emb
30001079	DL000165	1	12

Sangre artificial 15 ml
Cera deformaciones 15g
2x barra maquillaje
Espátula + Esponja



Ceras Maxi Dacs
Caja de 12 unidades

Código	Ref.	Color	U/Vta	U/Emb
16001147	DX060101	Blanco	1	24
16001143	DX060103	Amarillo	1	24
16001150	DX060106	Naranja	1	24
16001319	DX060126	Carne	1	24
16001154	DX060125	Rosa	1	24
16001153	DX060109	Rojo	1	24
16001360	DX060132	Marrón	1	24
16001156	DX060119	Verde pardo	1	24
16001155	DX060120	Verde medio	1	24
16001276	DX060147	Azul claro	1	24
16001144	DX060115	Azul celeste	1	24
16001145	DX060117	Azul turquesa	1	24
16001157	DX060113	Violeta	1	24
16001151	DX060136	Negro	1	24



Ceras Dacs

Código	Ref.	Estuche	U/Vta	U/Emb
16001069	DA050260	6 uds	1	200
16001070	DA050290	12 uds	1	120
16001072	DA050295	24 uds	1	40
16001073	DA050300	36 uds	1	12



Ceras Maxi
Estuche de 15 unidades surtidas

Código	Ref.	U/Vta	U/Emb
16001058	DX050216	1	24



Ceras Classbox
Estuche de 288 unidades surtidas

Código	Ref.	U/Vta	U/Emb
16001442	DA000050	1	6



Ceras Trix
Estuche de 12

Código	Ref.	U/Vta	U/Emb
16001266	DA000125	1	12



Estuche ceras Dacscolor

Código	Ref.	Estuche	U/Vta	U/Emb
16001075	DC050290	12 uds	1	60
16001077	DC050295	24 uds	1	24



Ceras color Classbox
Caja de 288 unidades (24 unidades x 12 colores)

Código	Ref.	U/Vta	U/Emb
16001441	DC000016	1	6



**Ceras Unicolor
Estuche de 12**

Código	Ref.	Artículo	U/Vta	U/Emb
16001019	MNC04475	Amarillo	1	100
16001445	MNC04453	Amarillo limón	1	100
16001390	MNC04486	Amarillo oscuro	1	100
16001456	MNC04704	Amarillo óxido	1	100
16001015	MNC04602	Azul	1	100
16001451	MNC04635	Azul cobalto	1	100
16001303	MNC04861	Azul cyan	1	100
16001191	MNC04613	Azul oscuro	1	100
16001304	MNC04624	Azul prusia	1	100
16001450	MNC04599	Azul turquesa	1	100
16001018	MNC04442	Bianco	1	100
16001301	MNC04817	Burdeos claro	1	100
16001337	MNC04760	Carne	1	100
16001302	MNC04840	Celeste claro	1	100
16001063	MNC04533	Granate	1	100
16001125	MNC05150	Gris oscuro	1	100
16001309	MNC05026	Índigo	1	100
16001054	MNC04828	Lila	1	100
16001299	MNC04588	Magenta	1	100
16001053	MNC04715	Marrón	1	100
16001062	MNC04497	Naranja	1	100
16001014	MNC04737	Negro	1	100
16001455	MNC04690	Ocre	1	100
16001479	MNC05060	Ocre madera	1	100
16001060	MNC05161	Oro	1	100
16001310	MNC05081	Óxido rojo	1	100
16001457	MNC04726	Pardo	1	100
16001059	MNC05172	Plata	1	100
16001024	MNC04522	Rojo	1	100
16001461	MNC04781	Rojo clásico	1	100
16001052	MNC04555	Rosa	1	100
16001447	MNC04544	Rosa natural	1	100
16001311	MNC05106	Tierra sombra tostado	1	100
16001022	MNC04657	Verde	1	100
16001466	MNC04908	Amarillo claro	1	100
16001307	MNC04920	Verde intenso	1	100
16001452	MNC04646	Verde natural	1	100
16001306	MNC04918	Verde oliva	1	100
16001064	MNC04679	Verde oscuro	1	100
16001123	MNC04839	Violeta azulado	1	100
16001449	MNC04577	Violeta claro	1	100
16001448	MNC04566	Violeta natural	1	100

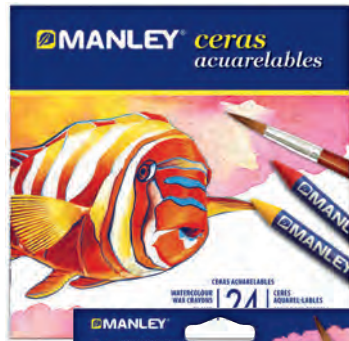

Ceras Acuarelables

Código	Ref.	Estuche	U/Vta	U/Emb
16001316	MNQ00412	12 uds	1	50
16001317	MNQ00424	24 uds	1	30



**Ceras Fluo&Pastel
Estuche de 10**

Código	Ref.	U/Vta	U/Emb
16001111	MNC00044	1	10



10x estuche 10 ud.
10x estuche 15 ud.
10x estuche 24 ud.

**Ceras
Expositor de 30 estuches**

Código	Ref.	U/Vta	U/Emb
16001097	MNC00101	1	1



Estuche de ceras en colores surtidos

Código	Ref.	Artículo	U/Vta	U/Emb
16001028	MNC00022	Estuche de 6	1	100
16001029	MNC00033	Estuche de 10	1	100
16001030	MNC00055	Estuche de 15	1	100
16001031	MNC00066	Estuche de 24	1	50
16001032	MNC00077	Estuche de 30	1	50
16001158	MNC00088	Estuche de 50	1	15
16001318	MNC00192	Caja de 192	1	6



Barniz Fijador

Código	Ref.	Artículo	U/Vta	U/Emb
25209145	MND00292	500 ml	1	15
25209090	MND00350	1000 ml	1	10



Ceras + afilalápiz resistentes

Código	Ref.	Uds	U/Vta	U/Emb
16001329	F47920000	10	1	30
16001297	F462700	40	1	4



Lápidos de colores Super lavables y seguros parte posterior antiafog

Código	Ref.	Uds	U/Vta	U/Emb
12801637	F46960000	6	1	30
12801638	F46970000	12	1	30
12801639	F461300	36	1	4



Rotuladores lavables y seguros con capuchón antiafog

Código	Ref.	Uds	U/Vta	U/Emb
10201599	F46980000	6	1	30
10201600	F46990000	12	1	30
10201601	F461200	36	1	4



Creative Set Pasta

Código	Ref.	U/Vta	U/Emb
24101470	F478400	1	4

- Novidad**
- 1x 100g Pasta Rojo
 - 1x 100g Pasta Amarillo
 - 1x 100g Pasta Azul
 - 1x 50g Pasta Blanco
 - 1x 50g Pasta Negro
 - 12x Super Rotuladores
 - 1x Rodillito
 - 1x Cuchillito
 - 2x Maxi moldes
 - 1x Libro para colorear



Set juego Little Creations

Código	Ref.	U/Vta	U/Emb
25001487	F479100	1	6



Expositor surtido Be-bè

Código	Ref.	U/Vta	U/Emb
18901399	F100211/F1001142X	1	1



Expositor surtido Be-bè

Código	Ref.	U/Vta	U/Emb
18901400	F100210/F100112	1	1

GIOTTO



- R Incluye Regalo**
- 12x F46960000 Súper Lápidos Est.6 + Sacap.
 - 12x F46980000 Súper Rotuladores Est.6
 - 6x F478900 Súper Rotuladores Cambiacolor. Est. 8
 - 12x F46970000 Súper Lápidos Est.12 Uds + Sacapuntas
 - 12x F46990000 Súper Rotuladores Est. 12
 - 4x F467200 Pintura A Dedos 4x150g
 - 12x F47920000 Súper Ceras Est. 10 + Sacap.
 - 5x F475100 Delantal con mangas ajustable
 - 10x F46620000 My 1st Glue Stick 20 g
 - 6x F462501 Súper Pasta Jugar 100g Est. 3
 - 9x F472700 Stick & Color Egg en Display 9
 - 5x F467600 Súper Cofre SIN CARGO

- 20x F276600 Giotto Colors 3.0 Est. 12
- 10x F276700 Giotto Colors 3.0 Est. 24
- 30x F416000 Giotto Turbo Color Est. 12
- 10x F417000 Giotto Turbo Color Est. 24
- 10x F454000 Giotto Turbo Maxi Est. 12
- 4x F257300 Giotto Stilnovo Est. 50
- 10x F351200 Giotto Acuarelas 30mm Est. 12 + pincel
- 10x F425800 Giotto Turbo Glitter Est. 8
- 40x F233800 Giotto Happy Gomma. Display de 40
- 120x F232900 Giotto Sacapuntas Fluo. Tarro de 120
- 24x F54350000 Giotto Vinilik Stick Duo 35g
- 10x F426800 Giotto Turbo Soft Brush Est. 10
- 12x F356600 Giotto Tèmpera Surtido 25 Ml. Est. 6 + pincel
- 1x F893900 Tratto Video Display de 108 SIN CARGO



12x Cera Bicolor
4x Pasteles en colores fluo
1x Collage Glue 120g
1x Tijera
1x Bloc de Cartulina Iris Neon 20h A4
1x Libro creativo

Juego Magic Neon Set Art

Código	Ref.	U/Vta	U/Emb
25001302	F582200	1	4



10x Turbo Soft Brush
12x 30mm Acuarelas
1x Turbo Maxi color negro
1x Happy Gomma
1x Lápiz de Grafito
1x Sacapuntas de metal
1 Bloc Canson Lettering 20h A4
1x Plantilla de letras
1x Libro Creativo

Juego Fancy Lettering Set Art

Código	Ref.	U/Vta	U/Emb
25001301	F582100	1	4



Goma de borrar Gomma Expositor de 120

Código	Ref.	Artículo	U/Vta	U/Emb
11101300	F232700	Col. fluo	1	6
11101302	F233900	Col. pastel	1	6



Goma de borrar Happy Gomma Expositor de 40

Código	Ref.	Artículo	U/Vta	U/Emb
11101278	F233800	Col. vivos	1	12
11101301	F234000	Col. pastel	1	12



Lápiz de grafito Matita con goma HB

Código	Ref.	U/Vta	U/Emb
12801928	F233200	12	720



Lápiz de colores 3.0

Código	Ref.	Estuche	U/Vta	U/Emb
12801535	F276600	12 uds	20	200
12801536	F276700	24 uds	10	100
12801539	F516900	Bote de 84	1	20
12801533	F523300	Pack de 192	1	4



Lápiz Stilnovo School

Código	Ref.	Estuche	U/Vta	U/Emb
12801428	F256500	12	1	120
12801429	F256600	24	1	60
12801531	F25670000	36	6	36
12801430	F51650000	Bote 84	1	20
12801677	F52340000	Pack 192	1	4



Lápices Skin Tones Stilnovo

Código	Ref.	Estuche	U/Vta	U/Emb
12801532	F257400	12 uds	1	40
12802245	F516200	Bote 48	1	15



Rotulador Turbo Soft Brush
Estuche de 10

Código	Ref.	Artículo	U/Vta	U/Emb
10204292	F426800	Col. vivos	10	10
10204980	F426900	Col. pastel	10	20



Rotulador Turbo Maxi Fluo
Estuche de 8

Código	Ref.	U/Vta	U/Emb
10204948	F453800	1	24



Rotulador fibra Turbo Glitter
Estuche de 8 colores

Código	Ref.	Ref.	U/Vta	U/Emb
10201919	F425800	Glitter	1	20
10203797	F426300	Glitter pastel	10	20



Rotulador Turbo Maxi. Tinta súperlavable

Código	Ref.	Colores	U/Vta	U/Emb
10201030	F454000	12 unidades	1	60
10201031	F455000	24 unidades	1	30
10201418	F521400	Bote 48 (12 col.)	1	14



Rotulador Turbo Color.
Tinta lavable, punta bloqueada, no se hunde, 2,8 mm

Código	Ref.	Colores	U/Vta	U/Emb
10201395	F416000	12 unidades	1	100
10201396	F417000	24 unidades	1	50
10201419	F521500	Bote 96 (12 col.)	1	15



Rotulador fibra Turbo Skin Tones

Código	Ref.	Estuche	U/Vta	U/Emb
10203529	F526900	12 uds	10	40
10203510	F526500	Bote de 32	1	8



Rotulador permanente Decor

Código	Ref.	Modelo	Estuche	U/Vta	U/Emb
10201514	F494900	Textile	12 uds	1	24
10201598	F453400	Materials	12 uds	1	24
10201515	F45290000	Metal	5 uds	1	30



Rotulador Schoolpack permanente Decor

Código	Ref.	Modelo	Caja	U/Vta	U/Emb
10201593	F52450000	Metal	25 uds	1	4
10201885	F494700	Textile	48 uds	1	4
10201615	F524600	Materials	48 uds	1	4



Pintura acrílica giotto 25 ml (bote)
colores surtidos

Código	Ref.	Estuche	U/Vta	U/Emb
23501131	F538200	6 uds	1	24
23501132	F530600	12 uds	1	10



Acuarelas 30 mm

Código	Ref.	Estuche	U/Vta	U/Emb
13501029	F331100	8 Metallic	10	40
13501030	F331200	8 Glitter	10	40
13501015	F351200	12 uds + 1 pincel	1	40
13501019	F352400	24 uds + 1 pincel	1	20
13501114	F353600	36 uds + 2 pinceles	1	10



Témpera líquida súper lavable
Bote de 500ml

Código	Ref.	Color	U/Vta	U/Emb
27401348	F535301	Blanca	1	6
27401349	F535302	Amarilla	1	6
27401350	F53530500	Naranja	1	6
27401351	F535306	Rosa	1	6
27401352	F53530700	Rojo Bermellón	1	6
27401353	F535308	Rojo Escarlata	1	6
27401354	F535310	Magenta	1	6
27401355	F535311	Verde Cinabrio	1	6
27401356	F535312	Verde	1	6
27401357	F535313	Verde Esmeralda	1	6
27401358	F535315	Cyan	1	6
27401359	F53531700	Azul Marino	1	6
27401360	F535318	Turquesa	1	6
27401361	F535319	Violeta	1	6
27401362	F535320	Rosa claro	1	6
27401363	F535324	Negro	1	6
27401364	F535328	Castaño	1	6



Témpera líquida colores especiales
Bote de 250ml

Código	Ref.	Color	U/Vta	U/Emb
27401265	F53140200	Metal Plata	1	8
27401266	F53140100	Metal Oro	1	8
27401157	F53110100	Flúor Amarillo	1	8
27401158	F53110200	Flúor Verde	1	8
27401159	F53110300	Flúor Naranja	1	8
27401160	F53110400	Flúor Rosa	1	8
27401175	F53120100	Glitter Oro	1	8
27401176	F53120200	Glitter Plata	1	8
27401177	F53120300	Glitter Magenta	1	8
27401178	F53120400	Glitter Cyan	1	8
27401179	F53120500	Glitter Verde	1	8
27401262	F53120600	Glitter Rojo	1	8
27401263	F53120700	Glitter Bronce	1	8
27401264	F53120800	Glitter Azul Oscuro	1	8
27401153	F53130100	Pearl Blanco	1	8
27401154	F53130200	Pearl Magenta	1	8
27401155	F53130300	Pearl Verde Claro	1	8
27401156	F53130400	Pearl Azul Cyan	1	8



Plastilina PatPlume 12 pastillas 350g

Código	Ref.	Color	U/Vta	U/Emb
24101110	F51220000	Surtido de 12	1	4
24101505	F51010100	Amarillo	1	4
24101517	F51010200	Rojo	1	4
24101506	F51010300	Azul oscuro	1	4
24101507	F51010400	Verde oscuro	1	4
24101508	F51010500	Negro	1	4
24101509	F51010600	Marrón	1	4
24101510	F51010700	Blanco	1	4
24101511	F51010800	Verde Claro	1	4
24101512	F51010900	Rosa	1	4
24101513	F51011000	Naranja	1	4
24101514	F51011100	Magenta	1	4
24101518	F51011200	Azul claro	1	4
24101515	F51011300	Plata	1	4
24101516	F51011400	Violeta	1	4



Plastilina PatPlume 350g
Caja de 6

Código	Ref.	Artículo	U/Vta	U/Emb
24101463	F515300	Colores primarios	1	1
24101464	F515400	Colores Skin Tones	1	1



Témpera líquida Botella de 25 ml + PINCEL

Código	Ref.	Estuche	U/Vta	U/Emb
27401422	F356600	6	6	24
27401423	F356700	12	1	10



Témpera acrílica Bote de 500ml

Código	Ref.	Color	U/Vta	U/Emb
27401674	F53370100	Blanco	1	6
27401675	F53370200	Amarillo	1	6
27401676	F53371500	Azul Cyan	1	6
27401677	F53372400	Negro	1	6
27401678	F53372800	Marrón	1	6
27401479	F53370800	Rojo	1	6
27401635	F53371000	Magenta	1	6
27401543	F53371200	Verde	1	6



Pintura de dedos
Bote de 750ml

Código	Ref.	Color	U/Vta	U/Emb
23501224	F472901	Blanco	1	10
23501225	F472902	Amarillo	1	10
23501226	F472905	Naranja	1	10
23501227	F472906	Rosa	1	10
23501228	F472910	Rojo	1	10
23501229	F472911	Verde	1	10
23501230	F472915	Azul	1	10
23501231	F472919	Violeta	1	10
23501232	F472924	Negro	1	10
23501233	F472928	Marrón	1	10



Témpera líquida Skin Tones bote de 250ml
Estuche surtido de 4

Código	Ref.	U/Vta	U/Emb
27401665	F542800	1	4



Cola blanca Vinilik

Código	Ref.	Tamaño	U/Vta	U/Emb
23101087	F543300	100g	12	48
23101104	F542900	1000g	6	6



Cola blanca Vinilik Stick Duo 35gr

Código	Ref.	U/Vta	U/Emb
23101252	F54350000	24	288



Cola blanca Vinilik con aplicador

Código	Ref.	Tamaño	U/Vta	U/Emb
23101362	F545700	40g	12	288
23101363	F545800	120g	12	96



Borrador Latex. Apta para pizarra negra

Código	Ref.	U/Vta	U/Emb
15101023	F692400	1	45



Rotulador pizarra Robercolor punta media Blíster de 4

Código	Ref.	U/Vta	U/Emb
10203073	F413300	1	20



Maquillaje Make Up Pintura facial cosmética Caja de 6 surtidos (bote de 5ml)

Código	Ref.	Artículo	U/Vta	U/Emb
30001232	F476300	Col. clásicos	5	50
30001164	F476500	Col. metálicos	5	50



Maquillaje Make Up Lápices cosméticos Caja de 6 surtidos

Código	Ref.	Artículo	U/Vta	U/Emb
30001231	F474200	Col. clásicos	5	50
30001165	F474300	Col. glamour	5	50



Tizas Robercolor en caja

Código	Ref.	Uds	Color	U/Vta	U/Emb
27901007	F538700	10	Blanca	1	160
27901008	F538900	10	Color	1	160
27901006	F538800	100	Blanca	1	16
27901009	F539000	100	Color	1	16



Portatizas Blíster 5+1 Uds.

Código	Ref.	U/Vta	U/Emb
24301568	F692300	1	24



Pasta de modelar Wood

Código	Ref.	Tamaño	U/Vta	U/Emb
24101479	F348700	350g	1	24
24101480	F348800	700g	1	12



Pasta de modelar. Seca al aire. Sin gluten

Código	Ref.	Color	Tamaño	U/Vta	U/Emb
14702005	F387000	Blanca	500g	1	24
14702007	F387500	Blanca	1000g	1	12
14702006	F387100	Terracota	500g	1	24
14702009	F387600	Terracota	1000g	1	12
24101430	F348200	Piedra	1000g	1	12





**Rotulador Aqua Brush Duo
Estuche de 6**

Código	Ref.	Colores	U/Vta	U/Emb
10203530	L6521062	Skin Tones	1	96
10203531	L6521063	Grises	1	96
10203532	L6521060	Primarios	1	96
10203533	L6521061	Pastel	1	96



**Rotulador Aqua Brush Duo
(rotulador+pincel)**

Código	Ref.	Uds	U/Vta	U/Emb
10201307	L6521120	12	1	72
10201308	L6521240	24	1	36
10201309	L6521360	36	1	24



**Set Rembrandt Polycolor + Art Desing
Estuche madera de 30**

Código	Ref.	U/Vta	U/Emb
12802474	L2004002	1	1



**Maletín de dibujo Rembrandt
Estuche madera de 31**

Código	Ref.	U/Vta	U/Emb
12802475	L2054002	1	1



**Lápiz Graduate Graphite Artistic
Caja de 6**

Código	Ref.	U/Vta	U/Emb
12802329	L1171061	1	360



**Lápiz Graduate Graphite Technical
Caja de 6**

Código	Ref.	U/Vta	U/Emb
12802330	L1171062	1	360



**Lápiz Graduate Graphite
Caja de 12**

Código	Ref.	U/Vta	U/Emb
12802128	L1171120	1	360



**Lápices de colores Graduate
Estuche de metal**

Código	Ref.	Estuche	U/Vta	U/Emb
12802248	L2871120	12 uds	5	60
12802249	L2871240	24 uds	3	42
12802250	L2871360	36 uds	1	22



**Lápices de colores Graduate Aquarell
Estuche de metal**

Código	Ref.	Estuche	U/Vta	U/Emb
12802459	L2881120	12 uds	5	60
12802460	L2881240	24 uds	3	42
12802461	L2881360	36 uds	1	22



N Novedad

6x Piedras
1x Pincel
3x Herramientas de punteado
10x Tubos de acrílico de 18ml

Set creativo Rock painting

Código	Ref.	U/Vta	U/Emb
25001303	D196250001	1	4



N Novedad

10x Hojas papel acuarela
2x Pinceles
1x Cinta de enmascarar
8 x Tubos de gouache de 12ml

Set creativo Masking

Código	Ref.	U/Vta	U/Emb
25001304	D196250002	1	4



N Novedad

3x Cartones entelados 15x15
1x Cuerda
2x Espátulas
10x Vasos
2x Guantes
9x Tubos de acrílico de 18ml

Set creativo Pouring

Código	Ref.	U/Vta	U/Emb
25001305	D196250003	1	4



N Novedad

6x Rodajas de madera
2x Pinceles
1x Rotulador acrílico
1x Cuerda
8x Tubos de acrílico de 12ml

Set creativo Madera

Código	Ref.	U/Vta	U/Emb
25001306	D196250004	1	4



N Novedad

9x Tubos de acuarela 12ml
3x Pinceles
3x Hojas papel acuarela
1x Guía de color

Set Simply de acuarela

Código	Ref.	U/Vta	U/Emb
13501211	D134500112	1	8



N Novedad

9x Tubos de gouache 12ml
3x Pinceles
3x Hojas papel gouache
1x Guía de color

Set Simply de témpera gouache

Código	Ref.	U/Vta	U/Emb
27401759	D126100112	1	8



N Novedad

9x Tubos de acrílico 12ml
2x Pinceles
1x Espátula
3x Hojas papel para acrílico
1x Guía de color

Set Simply de pintura acrílica

Código	Ref.	U/Vta	U/Emb
23501823	D126500112	1	8



N Novedad

9x Tubos de óleo 12ml
2x Pinceles
1x Espátula
3x Hojas papel para óleo
1x Guía de color

Set Simply de pintura óleo

Código	Ref.	U/Vta	U/Emb
23501824	D118500112	1	8



N Novedad

12x Tubos 12 ml
3x Pinceles
8x Papel de acrílico
1x Lápiz de dibujo
1x Paleta mezclas

Pintura acrílica 12ml Set de 25

Código	Ref.	U/Vta	U/Emb
23501781	D126500410	1	6



N Novedad

12x tubos acuarelas 12ml
3x pinceles
8x papel acuarela A4
1x lápiz de dibujo
1x paleta mezclas

Acuarelas 12ml Set de 25

Código	Ref.	U/Vta	U/Emb
13501201	D134500410	1	6



N Novedad

12x lápices distintas durezas
1x sanguina
1x lápiz sepia
2x lápices carboncillo
2x barras de mezcla
4x barras carboncillo
1x goma
1x afilalápiz
16x hojas A4 papel dibujo

Set de esbozo Estuche de 40

Código	Ref.	U/Vta	U/Emb
12802350	D644500410	1	6



N Novedad

Acuarelas Aquafine

Código	Ref.	Estuche	U/Vta	U/Emb
13501116	D131900001	12 uds	1	1
13501209	D131900102	24 uds	1	1



N Novedad

Pintura Óleo Graduate Oil 38ml Estuche de 10

Código	Ref.	U/Vta	U/Emb
23501774	D117900100	1	15



N Novedad

Pintura Acrílica Graduate 120ml Estuche de 5

Código	Ref.	U/Vta	U/Emb
23501811	D123900100	1	14

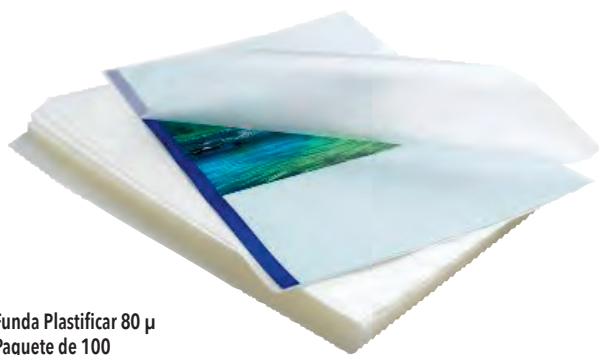

Funda Plastificar 80 µ
Paquete de 100

Código	Ref.	Tamaño	U/Vta	U/Emb
19801153	0101CC80	Carné de Conducir (110x230mm)	1	100
19801203	0101A580	A5 (154 x 216mm)	1	100
19801196	01020100	A4 (216 x 303mm)	1	1000
19801186	01020000	A3 (303 x 426mm)	1	500
19801076	0101A280	A2 (246 x 600mm)	1	100

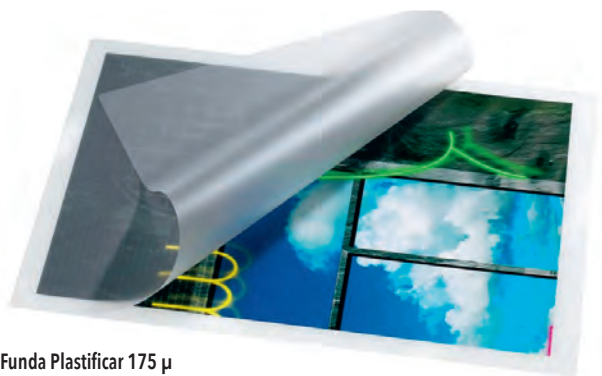

Funda Plastificar 175 µ
Paquete de 100

Código	Ref.	Tamaño	U/Vta	U/Emb
19801112	01022100	54X86	1	5000
19801116	0101B175	59x82	1	100
19801209	0101NI175	62X91 (NIF)	1	100
19801082	0101DN175	70X110	1	100
19801045	0101CP175	90X130 (Lic. caza pesca)	1	100
19801189	01022000	216x303 (A4)	1	500
19801058	0101F0175	220x320 (F ^o)	1	100
19801365	0101DOF02	303x426 (A3)	1	500



Funda Plastificar 125 µ
Paquete de 100

Código	Ref.	Tamaño	U/Vta	U/Emb
19801019	01021400	54X86	1	10000
19801157	01021700	62X91 (NIF)	1	5000
19801115	01021600	70X110	1	5000
19801038	01021500	90X130 (Lic. caza pesca)	1	5000
19801155	01021200	154x216 (A5)	1	2000
19801036	01021100	216x303 (A4)	1	1000
19801072	01021300	220x320 (F ^o)	1	1000
19801037	01021000	303x426 (A3)	1	500
19801077	0101A2125	426x600 (A2)	1	100



Portatodo ovalado surtido

Código	Ref.	U/Vta	U/Emb
11303217	10515534	1	36



Portatodo Sport surtido

Código	Ref.	U/Vta	U/Emb
24304739	10312726	3	36



Carpeta con pinza portablocs A4

Código	Ref.	Color	U/Vta	U/Emb
10401229	11226396	Azul	1	10
10401228	11205663	Negro	1	10
10401231	11226404	Lila	1	10
10401227	11205697	Transparente	1	10
10401230	11226610	Verde	1	10



Corrector Casete Fancy Roller Fantasía
5mm x 8m
Bote de 21

Código	Ref.	U/Vta	U/Emb
15103260	338673	1	1



Corrector cinta Maxi 4,2mm x 10m

Código	Ref.	U/Vta	U/Emb
15101047	340315	8	200



Corrector cinta Xycle 4,2mm x 8m

Código	Ref.	U/Vta	U/Emb
15101045	338210	10	100



Lápiz corrector 7ml Punta metálica

Código	Ref.	U/Vta	U/Emb
15101044	300919	12	12



Bolígrafo Stick Pro

Código	Ref.	Artículo	U/Vta	U/Emb
10103115	912261	Azul	20	12
10103116	912303	Negro	20	12
10103117	912329	Rojo	20	12

Bolígrafo K86S Super Soft

Código	Ref.	Artículo	U/Vta	U/Emb
10101178	601467	Azul	50	1200
10101177	601450	Negro	50	1200
10101179	601474	Rojo	50	1200
10101307	601481	Verde	12	12



36x Bolígrafo azul
18x Bolígrafo rojo
6x Bolígrafo negro
18x Recambio azul
6x Recambio negro
12x Recambio rojo

Bolígrafo Erase 2.0
Blíster de 1

Código	Ref.	Color	U/Vta	U/Emb
10101412	9584913	Azul	1	12
10101413	9584921	Negro	1	12
10101414	9582420	Rojo	1	12

Recambio Erase 2.0
Blíster de 2

Código	Ref.	Color	U/Vta	U/Emb
25401635	9585001	Azul	1	12
25401636	9585019	Negro	1	12
25401637	9566324	Rojo	1	12

Gama Erase 2.0
Expositor de 96

Código	Ref.	U/Vta	U/Emb
18901401	24007054	1	1



Bolígrafo Jazz pastel collection
Expositor de 12 surtido

Código	Ref.	U/Vta	U/Emb
30301779	603386	1	1



Pluma Twist triangular
Expositor de 15 surtido

Código	Ref.	U/Vta	U/Emb
30301781	605540	1	1



Pluma Pelikano Junior P67
Expositor de 12 surtido

Código	Ref.	U/Vta	U/Emb
10501069	669242	1	1



Tinta estilográfica TP/6
Caja de 6 cartuchos

Código	Ref.	Artículo	U/Vta	U/Emb
10601008	301176	Azul Real	1	50
10601156	301218	Negro	1	10
10601166	301192	Rojo Brillante	1	10
10601167	300087	Verde oscuro	1	10
10601170	301697	Violeta	1	10
10601169	301705	Turquesa	1	10
10601168	321075	Rosa	1	10



Barra Adhesiva Pelifix

Código	Ref.	Artículo	U/Vta	U/Emb
23102065	335653	10 Grs.	30	480
23102066	335810	20 Grs.	20	320
23102067	335671	40 Grs.	12	192



Lápiz de grafito N° 3 HB

Código	Ref.	Goma	U/Vta	U/Emb
12801904	978932	No	12	2160
12801906	979393	Si	12	1440

Lápiz de grafito N°3 HB Blister de 3

Código	Ref.	Goma	U/Vta	U/Emb
12801931	978841	No	10	240
12801482	978866	Si	10	240



Goma de borrar BR40 caucho mixta

Código	Ref.	U/Vta	U/Emb
88004236	601005	40	800



Goma de borrar AL20

Código	Ref.	U/Vta	U/Emb
88004234	606046	20	800



Lápices de colores Silverino triangular finos Estuche de 12

Código	Ref.	U/Vta	U/Emb
12802222	700634	10	120



Lápices de colores con goma borrable Estuche de 12

Código	Ref.	U/Vta	U/Emb
12802097	700689	10	120



Lápices de colores Combino triangular grueso Estuche de 12

Código	Ref.	U/Vta	U/Emb
12802096	811194	10	72



Lápices Aquarell hexagonales acuarelables estuche de 12 + pincel

Código	Ref.	U/Vta	U/Emb
12802221	700672	10	72



Lápiz de colores

Código	Ref.	Estuche	U/Vta	U/Emb
12801337	724005	12 Uds.	1	240
12801139	724013	24 Uds.	1	240
12801150	700139	36 Uds.	1	80



Ceras colores básicos con forma de ratón Blister de 6

Código	Ref.	U/Vta	U/Emb
16001094	803328	5	40



Afilalápiz 404 con depósito transparente surtido
Expositor de 12

Código	Ref.	U/Vta	U/Emb
13701157	700214	1	12



Afilalápiz V-Blade con depósito transparente
Expositor de 12

Código	Ref.	U/Vta	U/Emb
13701153	700238	1	6



Rotulador fibra Colorella Brushpen
Estuche de 10

Código	Ref.	U/Vta	U/Emb
10203463	814577	10	80



Rotulador Colorella Duo
Doble Punta Gruesa-Fina
Estuche de 10

Código	Ref.	U/Vta	U/Emb
10201793	813846	1	80



Rotulador Flúor Textmarker 490

Código	Ref.	Color	U/Vta	U/Emb
10202401	814089	Amarillo	10	200
10202402	814096	Verde	10	200
10202406	814126	Rojo	10	200
10202405	814119	Naranja	10	200
10202403	814102	Rosa	10	200
10202404	814133	Azul	10	200



Tijeras escolares Fancy 5
Blister de 1

Código	Ref.	U/Vta	U/Emb
27601128	804837	12	144



Tijeras escolares Fancy 5
Expositor de 24

Código	Ref.	U/Vta	U/Emb
27601129	804848	1	6



**Pintura de dedos Pelikan CD/405 40 ml (bote)
Set de 5**

Código	Ref.	U/Vta	U/Emb
23501234	24004954	1	56



Contenedor de agua antivuelco

Código	Ref.	U/Vta	U/Emb
12301226	800310	1	6



**Témpera Surtida 25ml 741
Estuche de 6**

Código	Ref.	U/Vta	U/Emb
27401050	804882	1	48



**Témpera Glitter 20ml (bote) 942/205
Estuche de 6**

Código	Ref.	U/Vta	U/Emb
27401152	24005203	1	6

**Témpera neón 40ml (bote)
Estuche de 6**

Código	Ref.	U/Vta	U/Emb
27401656	809382	1	6



Témpera 742 40 ml

Código	Ref.	Artículo	U/Vta	U/Emb
27401035	24005043	Blanca Nº4	6	72
27401034	24005050	Negra Nº11	6	72
27401037	24005067	Carmin Nº34	6	72
27401038	24005074	Magenta Nº43	6	72
27401036	24005081	Bermellón Nº58	6	72
27401039	24005098	Amarillo Nº59A	6	72
27401040	24005104	Naranja Nº59B	6	72
27401111	24005128	Violeta Nº109	6	72
27401043	24005142	Azul Cyan Nº127	6	72
27401048	24005159	Verde Azulado Nº130A	6	72
27401046	24005166	Verde Amarillo Nº155	6	72
27401041	24005173	Siena Tostada Nº190	6	72
27401151	24005197	Estuche de 6 surtido	1	10



**Acuarelas 735 K/24 cubrientes
Estuche de 24 + tubo color blanco**

Código	Ref.	U/Vta	U/Emb
13501194	720631	1	1



**Acuarelas 755/8 infantil
Estuche de 8 + pincel**

Código	Ref.	U/Vta	U/Emb
27401131	723122	1	6



Acuarela Junior Estuche de 12

Código	Ref.	U/Vta	U/Emb
13501006	700337	10	50



Acuarelas con pincel

Código	Ref.	Estuche	U/Vta	U/Emb
13501014	721324	12 colores	1	12
13501013	721670	22 colores	1	10



**Acuarelas 735 cubriente
estuche + tubo témpera blanca
Estuche de 12**

Código	Ref.	U/Vta	U/Emb
88004104	720854	1	30



Pincel pelo pony Serie 23

Código	Ref.	Artículo	U/Vta	U/Emb
12301244	711002	Nº 1	12	12
12301245	711010	Nº 2	12	12
12301246	711028	Nº 3	12	12
12301247	711036	Nº 4	12	12
12301248	711044	Nº 5	12	12
12301249	711051	Nº 6	12	12
12301250	722546	Nº 7	12	12
12301251	711069	Nº 8	12	12
12301252	722553	Nº 9	12	12
12301253	711077	Nº 10	12	12
12301254	722561	Nº 11	12	12
12301255	711085	Nº 12	12	12



Cuaderno Rebast La letra bien hecha "Mayúsculas"

Código	Ref.	Artículo	U/Vta	U/Emb
12607011	MAY.Nº0	Nº 0	5	350
12607010	MAY.Nº01	Nº 01	5	350
12607009	MAY.Nº02	Nº 02	5	350
12607012	MAY.Nº1	Nº 1	5	350
12607013	MAY.Nº2	Nº 2	5	350
12607014	MAY.Nº3	Nº 3	5	350
12607015	MAY.Nº4	Nº 4	5	350
12607016	MAY.Nº5	Nº 5	5	350
12607017	MAY.Nº6	Nº 6	5	350



Cuaderno Rebast La letra bien hecha "Minúsculas"

Código	Ref.	Artículo	U/Vta	U/Emb
12607002	MIN.Nº0	Nº 0	5	350
12607001	MIN.Nº01	Nº 01	5	350
12607003	MIN.Nº1	Nº 1	5	350
12607004	MIN.Nº2	Nº 2	5	350
12607005	MIN.Nº3	Nº 3	5	350
12607006	MIN.Nº4	Nº 4	5	350
12607007	MIN.Nº5	Nº 5	5	350
12607048	MIN.Nº6	Nº 6	5	350
12607008	MIN.Nº7	Nº 7	5	350



Cuaderno Rebast Matemáticas

Código	Ref.	Artículo	U/Vta	U/Emb
12607018	MAT.Nº1	Nº 1	5	250
12607019	MAT.Nº2	Nº 2	5	250
12607020	MAT.Nº3	Nº 3	5	250
12607021	MAT.Nº4	Nº 4	5	250
12607022	MAT.Nº5	Nº 5	5	250
12607023	MAT.Nº6	Nº 6	5	250
22201001	MAT.Nº7	Nº 7	5	250
22201002	MAT.Nº8	Nº 8	5	250



Cuaderno Rebast Fem la Llettra Ben Feta "Majusculas"

Código	Ref.	Artículo	U/Vta	U/Emb
12607035	MAY.Nº0-CAT	Nº 0	5	350
12607034	MAY.Nº01-CAT	Nº 01	5	350
12607033	MAY.Nº02-CAT	Nº 02	5	350
12607036	MAY.Nº1-CAT	Nº 1	5	350
12607037	MAY.Nº2-CAT	Nº 2	5	350
12607038	MAY.Nº3-CAT	Nº 3	5	350
12607039	MAY.Nº4-CAT	Nº 4	5	350
12607040	MAY.Nº5-CAT	Nº 5	5	350
12607041	MAY.Nº6-CAT	Nº 6	5	350



Cuaderno Rebast La Llettra Ben Feta "Minúsculas"

Código	Ref.	Artículo	U/Vta	U/Emb
12607025	MIN.Nº0-CAT	Nº 0	5	350
12607024	MIN.Nº01-CAT	Nº 01	5	350
12607026	MIN.Nº1-CAT	Nº 1	5	350
12607027	MIN.Nº2-CAT	Nº 2	5	350
12607028	MIN.Nº3-CAT	Nº 3	5	350
12607029	MIN.Nº4-CAT	Nº 4	5	350
12607030	MIN.Nº5-CAT	Nº 5	5	350
12607031	MIN.Nº6-CAT	Nº 6	5	350
12607032	MIN.Nº7-CAT	Nº 7	5	350



Cuaderno Rebast Matemàtiques

Código	Ref.	Artículo	U/Vta	U/Emb
12607042	MAT.Nº1-CAT	Nº 1	5	250
12607043	MAT.Nº2-CAT	Nº 2	5	250
12607044	MAT.Nº3-CAT	Nº 3	5	250
12607045	MAT.Nº4-CAT	Nº 4	5	250
12607046	MAT.Nº5-CAT	Nº 5	5	250
12607047	MAT.Nº6-CAT	Nº 6	5	250
22201004	MAT.Nº7-CAT	Nº 7	5	250
22201003	MAT.Nº8-CAT	Nº 8	5	250



Cuaderno rebast expositor combinado de 66
12 Ud. Matemáticas
27 Ud. Mayúsculas
27 Ud. Minúsculas

Código	Ref.	U/Vta	U/Emb
12607049	EXP.REBOST	1	1

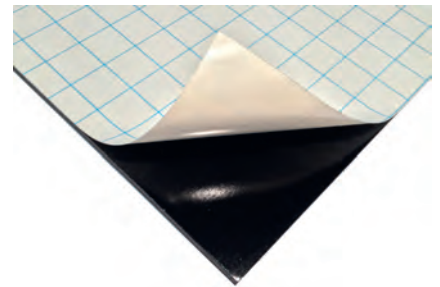
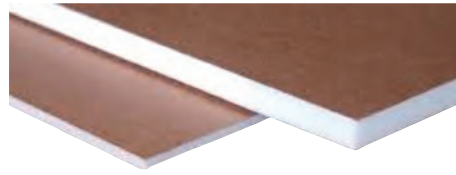
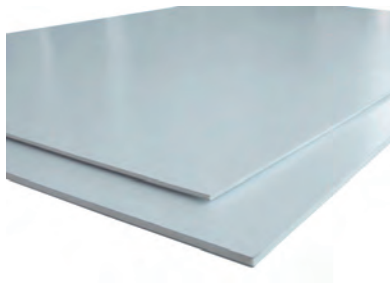

Cartón pluma precision

Código	Ref.	Color	Tamaño	U/Vta	U/Emb
25208012	272520103	Blanco	3 mm 50x70 cm	1	40
10707012	272520104	Blanco	3 mm 70x100 cm	1	40
25208013	272520203	Blanco	5 mm 50x70 cm	1	25
25208025	272520204	Blanco	5 mm 70x100 cm	1	25
10701390	2725203030	Blanco	10 mm 50x70 cm	1	15
25208089	2725203040	Blanco	10 mm 70x100 cm	1	15
10701391	2725204030	Negro	5 mm 50x70 cm	1	25
25208035	272520404	Negro	5 mm 70x100 cm	1	25

Cartón pluma precisión kraft 2 caras

Código	Ref.	Tamaño	U/Vta	U/Emb
10701396	2725204530	3 mm 50x70 cm	1	40
10701397	2725204540	3 mm 70x100 cm	1	40
10701398	2725204630	5 mm 50x70 cm	1	25
10701399	2725204640	5 mm 70x100 cm	1	25

Cartón pluma precision adhesivo

Código	Ref.	Color	Tamaño	U/Vta	U/Emb
10701392	2725203530	Blanco	5 mm 50x70 cm	1	25
10701393	2725203540	Blanco	5 mm 70x100 cm	1	25
10701394	2725501060	Negro	5 mm 50x70 cm	1	25
10701395	2725501065	Negro	5 mm 70x100 cm	1	25



Porta planos envío

Código	Ref.	Color	Artículo	U/Vta	U/Emb
24318004	1010200400	Naranja	112 x 10cm	1	11
24318005	1010300101	Kraft	50 x 5cm	1	40
24318007	1010300201	Kraft	50 x 7,6cm	1	18
24318008	1010300102	Kraft	70 x 5cm	1	40
24318009	1010300202	Kraft	70 x 6,5cm	1	24



Porta planos cartón verde

Código	Ref.	Artículo	U/Vta	U/Emb
24318001	1010100100	6,5x50	1	24
24318002	1010100200	6,5x70	1	24
24318003	1010100300	6,5x90	1	24



Fieltro Color

• 20x30cm

Código	Ref.	Color	U/Vta	U/Emb
19501035	1480300101	Blanco	10	120
19501036	1480300102	Amarillo	10	120
19501037	1480300103	Verde billar	10	120
19501038	1480300104	Verde claro	10	120
19501039	1480300105	Azul fuerte	10	120
19501040	1480300106	Azul claro	10	120
19501041	1480300107	Naranja	10	120
19501042	1480300108	Rojo	10	120
19501043	1480300109	Rosa	10	120
19501044	1480300110	Marrón	10	120
19501045	1480300111	Carne	10	120
19501046	1480300112	Lila	10	120
19501047	1480300113	Gris	10	120
19501034	1480300114	Negro	10	120

• 40x60cm

Código	Ref.	Color	U/Vta	U/Emb
19501021	1480300201	Blanco	5	30
19501022	1480300202	Amarillo	5	30
19501023	1480300203	Verde billar	5	30
19501024	1480300204	Verde claro	5	30
19501025	1480300205	Azul fuerte	5	30
19501026	1480300206	Azul	5	30
19501027	1480300207	Naranja	5	30
19501028	1480300208	Rojo	5	30
19501029	1480300209	Rosa	5	30
19501030	1480300210	Marrón	5	30
19501031	1480300211	Carne	5	30
19501032	1480300212	Lila	5	30
19501033	1480300213	Gris	5	30
19501049	1480300214	Negro	5	30

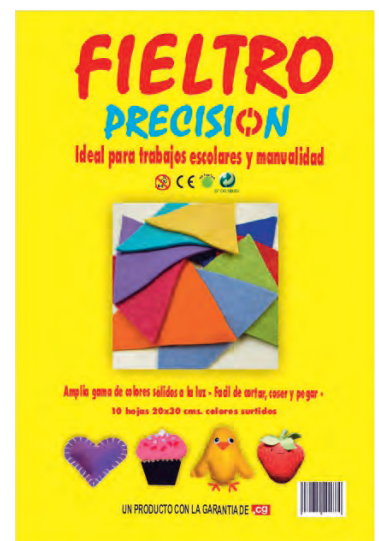

Blíster 10H/ Fieltro colores surtidos 20x30 cms

Código	Ref.	U/Vta	U/Emb
19501048	1480300099	1	12



Taladro goma Eva Precision 1,6 Cm.

Código	Ref.	Motivo	U/Vta	U/Emb
25208682	1478001049	Corona	1	10
25208684	1478001065	Nieve	1	10
25208760	1478001009	Osito	1	10
25208762	1478001011	Conejo	1	10
25208764	1478001019	Flor	1	10
25208765	1478001020	Lazo	1	10
25208766	1478001021	Trébol	1	10
25208768	1478001027	Flor 6 pétalos	1	10
25208769	1478001029	Pez	1	10
25208771	1478001034	Delfín	1	10
25208680	1478001052	Estrella	1	10
25208775	1478001056	Sol	1	10
25208776	1478001063	Mariposa	1	10
25208780	1478001073	Cohecito	1	10
25208685	1478001013	Árbol	1	10



Taladro goma Eva Precision 2,5 Cm.

Código	Ref.	Motivo	U/Vta	U/Emb
25208784	1478002007	Corona	1	10
25208785	1478002011	Flor 6 pétalos	1	10
25208788	1478002020	Mariposa	1	10
25208789	1478002021	Cuadrado	1	10
25208790	1478002023	Triángulo	1	10
25208791	1478002025	Nieve	1	10
25208793	1478002028	Lazo	1	10
25208795	1478002033	Pez	1	10
25208799	1478002039	Delfín	1	10
25208801	1478002041	Manzana	1	10



Taladro goma Eva Precision 3,8 Cm.

Código	Ref.	Motivo	U/Vta	U/Emb
25208806	1478003004	Hoja	1	10
25208808	1478003006	Flor 6 pétalos	1	10
25208809	1478003007	Mariposa	1	10
25208810	1478003008	Sol	1	10



Bloc de dibujo Milimetrado 50h

Código	Ref.	Artículo	U/Vta	U/Emb
10011013	1235150102	A3 - Mod. 510	1	10
10011012	1235150101	A4 - Mod. 500	1	10



Bloc de dibujo Vegetal 50h 80g

Código	Ref.	Artículo	U/Vta	U/Emb
10011008	1235100102	A3 - Mod. 301	1	10
10011007	1235100101	A4 - Mod. 300	1	10



Bolígrafo Scrikss Carnaval Expositor de 24 (4 colores)

Código	Ref.	U/Vta	U/Emb
30301962	7820009500	1	1



Bolígrafo Scrikss Mixto 180 Chrome Expositor de 36

Código	Ref.	U/Vta	U/Emb
30302498	7820000095	1	1



Bolígrafo Scrikss Smoothie 0,7 Expositor de 40

Código	Ref.	U/Vta	U/Emb
30301951	7822000010	1	1



Portaminas Scrikss Graph-X Expositor de 16 (8 de 0,5 + 8 de 0,7)

Código	Ref.	U/Vta	U/Emb
30301611	02506	1	1



280g

Bloc acuarela 280g con espiral

Código	Ref.	Artículo	U/Vta	U/Emb
10001512	1460305100	A5 (20 hojas)	5	5
10001513	1460305120	A4 (35 hojas)	5	5

120g

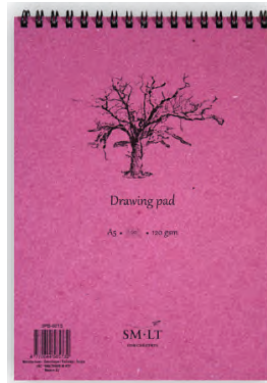

Bloc de dibujo A5 60h 120g con espiral

Código	Ref.	U/Vta	U/Emb
10001506	1460304550	5	5



200g

Bloc de dibujo Técnicas mixtas 40h 200g con espiral

Código	Ref.	Artículo	U/Vta	U/Emb
10001510	1460304805	A5	5	5
10001511	1460304810	A4	5	5



100g

Bloc para bocetos A4 100h 100g Bristol con espiral

Código	Ref.	U/Vta	U/Emb
10001666	1460305410	5	5



100g

Bloc para bocetos A5 70h 100g con espiral

Código	Ref.	U/Vta	U/Emb
10001516	1460304500	5	5



100g

Bloc para bocetos para rotulador A4 50h 100g con espiral

Código	Ref.	U/Vta	U/Emb
10001667	1460304030	5	5



100g

Bloc para bocetos A5 70h 100g color crema con espiral

Código	Ref.	U/Vta	U/Emb
10001508	1460305550	5	5



80g

Bloc para bocetos A4 100h 80g color crema con espiral

Código	Ref.	U/Vta	U/Emb
10001665	1460305610	5	5



135g

Bloc para bocetos papel kraft habana 80h 135g con espiral

Código	Ref.	Artículo	U/Vta	U/Emb
10001514	1460304705	A5	5	5
10001515	1460304710	A4	5	5



Pintura satinada multiuso (Base agua) 35 ml

También disponible bote de 75 ml

Código	Ref.	Color	U/Vta	U/Emb
27401000	110922	Amarillo limón	6	240
27401080	110422	Amarillo oro	6	240
27401069	110222	Azul intenso	6	240
27401068	112022	Azul pastel	6	240
27401081	110722	Azul ultramar	6	240
27401063	110322	Bermellón	6	240
27401061	110122	Blanco	6	240
27401002	111222	Carmin	6	240
27401051	118322	Cian	6	240
27401076	112122	Gris plata	6	240
27401064	113222	Magenta	6	240
27401079	112922	Marfil	6	240
27401070	111522	Marrón	6	240
27401065	111322	Naranja	6	240
27401062	110622	Negro	6	240
27401071	111022	Óxido amarillo	6	240
27401074	111122	Óxido rojo	6	240
27401060	112222	Rosa	6	240
27401072	111622	Siena claro	6	240
27401078	111722	Siena oscuro	6	240
27401077	111822	Sombra tostada	6	240
27401001	116922	Terracota	6	240
27401067	111922	Verde manigua	6	240
27401075	110822	Verde monte	6	240
27401066	110522	Verde vivo	6	240
27401073	111422	Violeta	6	240
27401015	119097	Estuche de 6	1	50



Pintura látex Fluorescente bote de 35ml Estuche de 6

Código	Ref.	U/Vta	U/Emb
25209079	119397	1	50



Pintura para cristal bote de 25ml Estuche de 6

Código	Ref.	U/Vta	U/Emb
23501601	999994	1	50



Pintura para tela opaca y metalizada Expositor de 54

Código	Ref.	U/Vta	U/Emb
23501899	090920C	1	1



Laca transparente cristal, frasco de 50ml Expositor de 21

Código	Ref.	U/Vta	U/Emb
23501605	090913C	1	1



Pintura látex, bote de 75ml Expositor de 24

Código	Ref.	U/Vta	U/Emb
23501604	090911C	1	1



Pintura látex fosforescente, bote de 75ml

Código	Ref.	Color	U/Vta	U/Emb
23501597	145416	Neutro	6	72
23501598	152316	Rosa	6	72
23501599	152616	Amarillo	6	72
23501600	152716	Azul	6	72
23501606	090912C	Expositor de 24	1	1



Pintura Látex 35ml Expositor de 54

Código	Ref.	U/Vta	U/Emb
23501751	090915C	1	1

Pintura para tela 25 ml

Código	Ref.	Color	U/Vta	U/Emb
25209126	113671	Amarillo claro	6	288
25209123	112871	Amarillo real	6	288
25209127	113771	Azul victoria	6	288
25209129	114371	Blanco	6	288
25209134	118071	Cian	6	288
25209125	113571	Escarlata	6	288
25209136	191971	Gamuza	6	288
25209133	117871	Lila	6	288
25209132	117171	Magenta	6	288
25209128	114171	Negro	6	288
25209131	115471	Óxido amarillo	6	288
25209135	118171	Rojo inglés	6	288
25209130	114571	Sombra natural	6	288
25209064	113371	Verde esmeralda	6	288
25209137	192171	Verde musgo	6	288
25209122	112471	Verde primavera	6	288
27401055	119494	Estuche de 6	1	50
23501752	090916C	Expositor 54 - Opaque	1	1
25209138	970005	Expositor 232	1	1



Pintura acrílica 60 ml

Código	Ref.	Color	U/Vta	U/Emb
23501238	177776	Amarillo oro	6	84
23501250	180276	Azul bebé	6	84
23501251	180476	Azul real	6	84
23501262	183276	Azul ultramar	6	84
23501236	177476	Blanco	6	84
23501258	182376	Bronce	6	84
23501242	178276	Carmin	6	84
23501246	179476	Carne	6	84
23501249	180176	Chocolate oscuro	6	84
23501264	198376	Cian	6	84
23501260	186676	Gamuza	6	84
23501244	179076	Lavanda	6	84
23501265	198776	Magenta	6	84
23501237	177576	Marfil	6	84
23501245	179276	Marrón antiguo	6	84
23501263	187576	Nácar	6	84
23501240	178076	Naranja	6	84
23501255	181976	Negro	6	84
23501239	177976	Ocre	6	84
23501257	182176	Oro real	6	84
23501256	182076	Oro rico	6	84
23501243	178976	Orquídea	6	84
23501248	180076	Óxido rojo	6	84
23501252	181276	Pistacho	6	84
23501259	182476	Plata	6	84
23501241	178176	Rojo	6	84
23501261	186976	Rosa bebé	6	84
23501247	179776	Terracota	6	84
23501254	181676	Verde bosque	6	84
23501253	181476	Verde medio	6	84
23501750	090914C	Expositor de 54	1	1
23501266	999758	Expositor de 180	1	1



Foto Transfer

Código	Ref.	Artículo	U/Vta	U/Emb
23501527	143740	Rotulador blíster	6	6
23599001	196616	Bote 75 ml	6	72
23599002	196611	Bote 250 ml	6	6
23599003	1307	Exp. 42 - 75 ml	1	1



NAVIGATOR UNIVERSAL

Papel 500 Hojas 80g.
Rendimiento incomparable, 99,99% libre de atascos. Su espesura, opacidad y blancura garantizan los mejores resultados de impresión en documentos a color.

Código	Ref.	Tamaño	U/Vta	U/Emb
12701009	NUN0800272	A4	5	5
12701008	NUN0800264	A3	5	5



NAVIGATOR ORGANIZER

Papel A4 500 Hojas 80g 4 taladros

Código	Ref.	U/Vta	U/Emb
12701104	NUN0800289	5	5



NAVIGATOR ECO-LOGICAL

Papel 500 Hojas 75g.
Campaña de un nombre a un árbol. Navigator ecológica garantiza una calidad y productividad superior en cualquier documento, garantizando 100% satisfacción. Certificado FSC.

Código	Ref.	Tamaño	U/Vta	U/Emb
12701299	NEC0750035	A4	5	5
12701330	NEC07500057	A3	5	5



NAVIGATOR EXPRESSION

Papel 500 Hojas 90g.
Papel extra blanco para chorro de tinta. Superficie extra suave con micro poros. Papel grueso y con gran opacidad para prevenir transparencia y ondulaciones.

Código	Ref.	Tamaño	U/Vta	U/Emb
12701027	NEX0900100	A4	5	5
12701028	NEX0900097	A3	5	5



NAVIGATOR PRESENTATION

Papel 500 Hojas 100g.
Papel extra blanco para presentaciones. Superficie extra suave con micro poros. Papel grueso y con gran opacidad para prevenir transparencia y ondulaciones.

Código	Ref.	Tamaño	U/Vta	U/Emb
12701374	NPR1000070	A4	5	5
12701037	NPR1000067	A3	4	4



NAVIGATOR COLOUR DOCUMENTS

Papel A4 250 Hojas 120g.
Ultra suave para la mejor calidad de impresión. Alcance la mejor definición de imagen en sus documentos en color como: presentaciones, cartas, dossieres o catálogos.

Código	Ref.	U/Vta	U/Emb
12701100	NCD1200057	8	8



NAVIGATOR OFFICE CARD

Papel A4 250 Hojas 160g.
El mejor para impresiones digitales. Láser color. Contraste de colores garantizado. Alto espesor y opacidad para imprimir documentos de mayor calidad a todo color.

Código	Ref.	U/Vta	U/Emb
12701307	NOC1600016	5	5



NAVIGATOR BOLD DESIGN

Papel A4 150 Hojas 200g
Se adapta a los requisitos de impresión digital y potencia cada uno de sus resultados.

Código	Ref.	U/Vta	U/Emb
12701663	NBC989477	7	7



NAVIGATOR HARD COVER

Papel A4 125 Hojas 250g
Se adapta a los requisitos de impresión digital y potencia cada uno de sus resultados.

Código	Ref.	U/Vta	U/Emb
12701664	NHC989453	7	7



NAVIGATOR HOME PACK

Papel A4 80g.
Envase más ligero y fácil de transportar reduciendo el número de hojas por paquete.

Código	Ref.	Artículo	U/Vta	U/Emb
12701402	NHP80EN851	250 hojas	10	10
12701515	NHP084107	125 hojas	12	12



DISCOVERY

Papel 500 Hojas 75g.
Para las más exigentes máquinas de oficina, con una calidad superior a un standard 80g, utilizando menos recursos naturales.

Código	Ref.	Tamaño	U/Vta	U/Emb
12701038	NDI0750117	A4	5	5
12701016	NDI0750109	A3	5	5



Pistola de cola termofusible 25W
(Barras 7,4mm ø)

Código	Ref.	U/Vta	U/Emb
23101283	5100003	1	48



Pistola de cola termofusible 70W
(Barras 11,2mm ø)

Código	Ref.	U/Vta	U/Emb
23101284	5100009	1	48



Cinta adhesiva de color Opp
19mm x 63m

Código	Ref.	Color	U/Vta	U/Emb
23101180	1851901	Amarillo	6	96
23101181	1851902	Azul	6	96
23101182	1851903	Rojo	6	96
23101183	1851904	Verde	6	96
23101184	1851905	Blanco	6	96
23101185	1851907	Naranja	6	96
23101186	1851908	Negro	6	96



Cinta adhesiva de color Opp
48mm x 63m

Código	Ref.	Color	U/Vta	U/Emb
23101187	1854801	Amarillo	6	96
23101188	1854802	Azul	6	96
23101189	1854803	Rojo	6	96
23101190	1854804	Verde	6	96
23101191	1854805	Blanco	6	96
23101192	1854807	Naranja	6	96
23101193	1854808	Negro	6	96



Silicona líquida Fix 100ml
Expositor de 15

Código	Ref.	U/Vta	U/Emb
23101115	1001100	1	2



Tejido no tejido PP 70 gr. Rollo 0,81x3 m.
Expositor de 28

Código	Ref.	U/Vta	U/Emb
25201141	5071000	1	2



Carpeta de fundas (tarifario) A4 PP canguro

• 20 fundas

Código	Ref.	Color	U/Vta	U/Emb
15302759	4240020	Negro	12	48
15302760	4240021	Transparente	12	48
15302761	4240022	Azul	12	48
15302762	4240023	Rojo	12	48
15302763	4240024	Verde	12	48
15302764	4240025	Naranja	12	48
15302765	4240026	Lila	12	48

• 30 fundas

Código	Ref.	Color	U/Vta	U/Emb
15302766	4240030	Negro	12	48
15302767	4240031	Transparente	12	48
15302768	4240032	Azul	12	48
15302769	4240033	Rojo	12	48
15302770	4240034	Verde	12	48
15302771	4240035	Naranja	12	48
15302772	4240036	Lila	12	48

• 40 fundas

Código	Ref.	Color	U/Vta	U/Emb
15302773	4240040	Negro	12	36
15302774	4240041	Transparente	12	36
15302775	4240042	Azul	12	36
15302776	4240043	Rojo	12	36
15302777	4240044	Verde	12	36
15302778	4240045	Naranja	12	36
15302779	4240046	Lila	12	36

• 50 fundas

Código	Ref.	Color	U/Vta	U/Emb
15302780	4240050	Negro	12	24
15302781	4240051	Transparente	12	24
15302782	4240052	Azul	12	24
15302783	4240053	Rojo	12	24
15302784	4240054	Verde	12	24
15302785	4240055	Naranja	12	24
15302786	4240056	Lila	12	24

• 60 fundas

Código	Ref.	Color	U/Vta	U/Emb
15302787	4240060	Negro	12	24
15302788	4240061	Transparente	12	24
15302789	4240062	Azul	12	24
15302790	4240063	Rojo	12	24
15302791	4240064	Verde	12	24
15302792	4240065	Naranja	12	24
15302793	4240066	Lila	12	24
15302794	4240260	Negro opaco	12	24



• 75mm

Código	Ref.	Tamaño	Color	U/Vta	U/Emb
11601363	OL2071AM	Fº	Amarillo	1	12
11601364	OL2071AZ	Fº	Azul	1	12
11601467	OL2071BL	Fº	Blanco	1	12
11601561	OL2071NA	Fº	Naranja	1	12
11601365	OL2071NE	Fº	Negro	1	12
11601366	OL2071RJ	Fº	Rojo	1	12
11601367	OL2071VD	Fº	Verde	1	12
11601690	OL2071VC	Fº	Verde claro	1	12
11601691	OL2071AC	Fº	Azul claro	1	12
11601692	OL2071VI	Fº	Violeta	1	12
11601693	OL2071RS	Fº	Rosa	1	12
11601069	OL2070AM	A4	Amarillo	1	12
11601068	OL2070AZ	A4	Azul	1	12
11601380	OL2070BL	A4	Blanco	1	12
11601577	OL2070GR	A4	Gris	1	12
11601417	OL2070NA	A4	Naranja	1	12
11601052	OL2070NE	A4	Negro	1	12
11601070	OL2070RJ	A4	Rojo	1	12
11601033	OL2070VD	A4	Verde	1	12
11601686	OL2070VC	A4	Verde claro	1	12
11601687	OL2070AC	A4	Azul claro	1	12
11601688	OL2070VI	A4	Violeta	1	12
11601689	OL2070RS	A4	Rosa	1	12

Archivador palanca plastificado color

• 50mm

Código	Ref.	Tamaño	Color	U/Vta	U/Emb
11601426	OL2046AM	Fº	Amarillo	1	12
11601428	OL2046AZ	Fº	Azul	1	12
11601997	OL2046NE	Fº	Negro	1	12
11601425	OL2046RJ	Fº	Rojo	1	12
11601427	OL2046VD	Fº	Verde	1	12
11601418	OL2045AM	A4	Amarillo	1	12
11601419	OL2045AZ	A4	Azul	1	12
11601420	OL2045BL	A4	Blanco	1	12
11601576	OL2045GR	A4	Gris	1	12
11601421	OL2045NA	A4	Naranja	1	12
11601422	OL2045NE	A4	Negro	1	12
11601423	OL2045RJ	A4	Rojo	1	12
11601424	OL2045VD	A4	Verde	1	12



Archivador palanca cartón jaspeado negro 75mm

• Archivador

Código	Ref.	Artículo	U/Vta	U/Emb
11601091	OL2021	Fº	1	25
11601135	OL2022	A4	1	25
11601134	OL2025	4º apaisado	1	24
11601133	OL2024	4º natural	1	24

• Caja 82mm

Código	Ref.	Artículo	U/Vta	U/Emb
11602219	07170000	Fº	1	25
11602218	07160000	A4	1	25
11602557	07150000	4º apaisado	1	24
11602217	07140000	4º natural	1	24

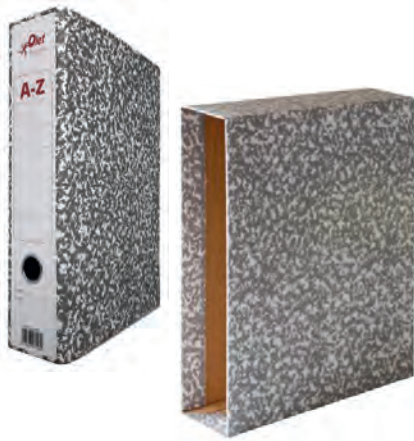

Archivador palanca Fº cartón jaspeado gris 75mm

• Archivador

Código	Ref.	U/Vta	U/Emb
11601362	OL2001	1	500

• Caja 82mm

Código	Ref.	U/Vta	U/Emb
11602577	07170071	1	500



**Fundas multitaladro polipropileno Fº 90µ
16 taladros reforzados
Pack de 10**

Código	Ref.	Artículo	U/Vta	U/Emb
19801512	P10PN	Piel de naranja	1	1
19801513	P10CR	Cristal liso	1	1

**Fundas multitaladro polipropileno
16 taladros reforzados
Pack de 100**

Código	Ref.	Artículo	U/Vta	U/Emb
19801491	90FPN	90µ piel naranja Fº	1	100
19801492	90A4PN	90µ piel naranja A4	1	100
19801493	70FPN	70µ piel naranja Fº	1	100
19801494	70A4PN	70µ piel naranja A4	1	100
19801495	90FCR	90µ cristal liso Fº	1	100
19801496	90A4CR	90µ cristal liso A4	1	100



Papel A4 80g 500h Copy

Código	Ref.	U/Vta	U/Emb
12701058	OLEFCOPY	5	5



Caja archivo definitivo cartón automontable System Easy

Código	Ref.	Artículo	U/Vta	U/Emb
11601256	DF100EASY	A4	10	10
11601257	DF200EASY	Fº	10	10



Caja archivo definitivo cartón

Código	Ref.	Artículo	U/Vta	U/Emb
11601129	A100	Fº	50	3000
11601130	A200	Fº prolongado	50	3000



Contenedor de archivos cartón kraft Para 4 archivadores tamaño Fº 412 x 383 x 273mm

Código	Ref.	U/Vta	U/Emb
29701108	4DEF-FOL	1	200



90g

Bloc espiral, tapa polipropileno - 80 hojas, 8 colores surtidos.

Código	Ref.	Tamaño	Rayado	U/Vta	U/Emb
10002398	BPF9033	Fº	3x3	8	32
10002277	BPF9044	Fº	4x4	8	24
10002394	BPF9055	Fº	5x5	8	24
10002278	BPF90HZ	Fº	Horizontal	8	24
10002355	BPF90LS	Fº	Liso	8	24
10002205	BPF9025	Fº	Pauta 2,5	8	24
10002318	BPF9035	Fº	Pauta 3,5	8	24
10002208	BPF90MM	Fº	Milimetrado	8	24
10001392	BPC9033	4º	3x3	8	48
10001347	BPC9044	4º	4x4	8	48
10001348	BPC90HZ	4º	Horizontal	8	48
10001371	BPC90LS	4º	Liso	8	48
10001349	BPC9025	4º	Pauta 2,5	8	48
10001386	BPC9035	4º	Pauta 3,5	8	48



Bloc tapa normal 80 hojas cuadrícula 4x4 60g
8 colores surtidos

Código	Ref.	Tamaño	U/Vta	U/Emb
10006085	16553	8º	10	240
10006084	16554	8º apaisado	10	240
10004010	16555	12º	10	320
10004009	16556	12º apaisado	10	360
10005205	16557	16º	10	420
10005204	16558	16º apaisado	10	400

sintetic plus



Bloc espiral tapa PP 80 hojas. Colores surtidos

Código	Ref.	Tamaño	U/Vta	U/Emb
10001546	BP126044AP	12º apaisado	20	240
10001547	BP126044	12º	20	240
10001504	BP166044AP	16º apaisado	20	320
10001545	BP166044	16º	20	360
10001548	BP86044AP	8º apaisado	20	420
10001549	BP86044	8º	20	400



90g

Bloc tapa extra dura 80h 4x4 90g 5 colores surtidos

Código	Ref.	Formato	U/Vta	U/Emb
10002391	BEF9044	Fº	5	25



PACK 5 + 1
Blocs de tapa dura compacta con papel extra blanco

Bloc Fº espiral 80 hojas 90g tapa dura Pack 5+1

Código	Ref.	Formato	U/Vta	U/Emb
10001399	BDF90HZ	Horizontal	1	4
10002385	BDF9044	Cuadrícula 4x4	1	4

90g



Libreta grapada tapa polipropileno 48h con margen 90g
8 colores surtidos

Código	Ref.	Tamaño	Rayado	U/Vta	U/Emb
20902067	LPA49044	A4	Cuadrícula 4x4	6	36
20902068	LPA490HZ	A4	Horizontal	6	36
20902070	LPA490LS	A4	Liso	6	36
20902069	LPA49035	A4	Pauta 3,5	6	36
20902071	LPA59044	A5+	Cuadrícula 4x4	6	72
20902072	LPA590HZ	A5+	Horizontal	6	72
20902074	LPA590LS	A5+	Liso	6	72
20902073	LPA59035	A5+	Pauta 3,5	6	72

90g



Cartulina A4 blanca 180g

Código	Ref.	U/Vta	U/Emb
10701559	CBLA-50	50	500



Cartulina A4 185g
Paquete de 50

Código	Ref.	Artículo	U/Vta	U/Emb
10701841	07524	Col. intensos	1	10
10701842	07525	Col. pálidos	1	10



Recambio A4 100h 100g 4 taladros
Cuadrícula 4x4

Código	Ref.	U/Vta	U/Emb
25401034	R1004X4	1	25



Papel liso 80g

Código	Ref.	Artículo	U/Vta	U/Emb
12701340	PLA80LS	A4 - 100h	25	25
12702001	8221500	A5 - 500h	1	12



Papel A4 100h 90g Liso

Código	Ref.	U/Vta	U/Emb
12701341	PLA90LS	20	20



Papel A4 100h 80g cuadrícula 4x4

Código	Ref.	U/Vta	U/Emb
12701334	PLA8044	25	25



Hasta fin de existencias

Recambio A4 80h 100g 4 taladros
Cuadrícula 5x5

Código	Ref.	Color	U/Vta	U/Emb
25401424	R100AMA	Amarillo	5	30
25401425	R100NAR	Naranja	5	30
25401426	R100ROS	Rosa	5	30
25401427	R100VIO	Violeta	5	30



Recambios 90g 100h

Código	Ref.	Tamaño	Taladros	Rayado	U/Vta	U/Emb
25401186	RAM9044	Fº	Multitaladros	4x4	10	20
25401192	RAC9033	A4	4 Taladros	3x3	10	20
25401195	RAC9044	A4	4 Taladros	4x4	10	20
25401193	RAC9055	A4	4 Taladros	5x5	10	20
25401196	RAC90HZ	A4	4 Taladros	Horizontal	10	20
25401194	RAC90LS	A4	4 Taladros	Liso	10	20
25401198	RAC90MM	A4	4 Taladros	Milimetrado	10	20
25401197	RAC9025	A4	4 Taladros	Pauta 2,5	10	20



Carpeta Fundas (Tarifario) Twist PP flexible A4.

• 20 FUNDAS

Código	Ref.	Color	U/Vta	U/Emb
15301878	TW20AZ	Azul	1	20
15301879	TW20LI	Lima	1	20
15301880	TW20NA	Naranja	1	20
15301881	TW20RO	Rojo	1	20
15301882	TW20VE	Verde	1	20

• 30 FUNDAS

Código	Ref.	Color	U/Vta	U/Emb
15301883	TW30AZ	Azul	1	20
15301884	TW30LI	Lima	1	20
15301885	TW30NA	Naranja	1	20
15301886	TW30RO	Rojo	1	20
15301887	TW30VE	Verde	1	20



• 40 FUNDAS

Código	Ref.	Color	U/Vta	U/Emb
15301888	TW40AZ	Azul	1	20
15301889	TW40LI	Lima	1	20
15301890	TW40NA	Naranja	1	20
15301891	TW40RO	Rojo	1	20
15301892	TW40VE	Verde	1	20

• 50 FUNDAS

Código	Ref.	Color	U/Vta	U/Emb
15301893	TW50AZ	Azul	1	20
15301894	TW50LI	Lima	1	20
15301895	TW50NA	Naranja	1	20
15301896	TW50RO	Rojo	1	20
15301897	TW50VE	Verde	1	20

• 60 FUNDAS

Código	Ref.	Color	U/Vta	U/Emb
15301898	TW60AZ	Azul	1	20
15301899	TW60LI	Lima	1	20
15301900	TW60NA	Naranja	1	20
15301901	TW60RO	Rojo	1	20
15301902	TW60VE	Verde	1	20



Hasta fin de existencias

Carpeta de proyectos F° cartón forrado, cierre con gomas

Código	Ref.	Lomo	Color	U/Vta	U/Emb
10402967	OL950080	30mm	Azul	1	10
10402966	OL950079	30mm	Negro	1	10
10402968	OL950082	30mm	Verde	1	10
10402970	OL950084	50mm	Azul	1	8
10402969	OL950083	50mm	Negro	1	8
10402971	OL950086	50mm	Verde	1	8
10402973	OL950088	70mm	Azul	1	6
10402972	OL950087	70mm	Negro	1	6
10402974	OL950090	70mm	Verde	1	6
10402976	OL950092	90mm	Azul	1	5
10402975	OL950091	90mm	Negro	1	5
10402977	OL950099	90mm	Verde	1	5

Carpeta Fundas (Tarifario) PP Trans. A4 Colores surtidos

Código	Ref.	Artículo	U/Vta	U/Emb
15301509	5110K	10 Fundas	1	40
15301510	5120K	20 Fundas	1	40
15301511	5130K	30 Fundas	1	30
15301512	5140K	40 Fundas	1	20
15301641	5150K	50 Fundas	1	20
15301642	5160K	60 Fundas	1	12

Contenido:
2 Ud. de 10 fundas
5 Ud. de 20 fundas
6 Ud. de 30 fundas
4 Ud. de 40 fundas
2 Ud. de 50 fundas

Carpeta Fundas (Tarifario) PP Trans. A4 Expositor 19 surtidos

Código	Ref.	U/Vta	U/Emb
15301643	5126KE-OLEF	1	1



Expositor vacío
Regalo por la compra
(sin cargo)
de 120 marcadores Olef
Cód: 10203245
Ref: OLEF.EXP

Marcador flúor

Código	Ref.	Artículo	U/Vta	U/Emb
10202349	OLF502	Azul	10	60
10202350	OLF503	Naranja	10	60
10202351	OLF504	Verde	10	60
10202352	OLF500	Amarillo	10	60
10202353	OLF501	Rosa	10	60
10201085	OLF4COL	Bolsa de 4 colores	1	144
10203245	OLEF.EXP.VACIO	Expositor vacío*	1	1



Corrector cinta ergonómico Uuups 5mm x 12m

Código	Ref.	U/Vta	U/Emb
15101065	OLC01	24	864



Corrector cinta mini Super Uuups 5mm x 5m

Código	Ref.	U/Vta	U/Emb
15101068	OLC02	24	648



Cinta adhesiva invisible rollo 33m x 19mm

Código	Ref.	U/Vta	U/Emb
11901042	OL3319M	1	480



Cinta adhesiva en rollo

Código	Ref.	Medida	U/Vta	U/Emb
11901084	OL3312	33m x 12mm	12	720
11903015	OL3319	33m x 19mm	8	480
11901086	OL6612	66m x 12mm	12	720



Cinta de embalaje polipropileno rollo de 66m x 48mm

Código	Ref.	Color	U/Vta	U/Emb
11903018	OL6648MARR	Marrón	6	72
11903017	OL6648TRANP	Transparente	6	72



Mochila Day Pack sencilla

Código	Ref.	Color	U/Vta	U/Emb
11001127	631995774	Azul	1	1
11001129	631996774	Negro	1	1
11001131	631997774	Rojo	1	1
11001133	631998774	Verde	1	1
11001135	631999774	Rosa	1	1

Mochila Day Pack para portátil 14,1"

Código	Ref.	Color	U/Vta	U/Emb
11001128	631995819	Azul	1	1
11001130	631996819	Negro	1	1
11001132	631997819	Rojo	1	1
11001134	631998819	Verde	1	1
11001136	631999819	Rosa	1	1

Portatodo triple plano

Código	Ref.	Color	U/Vta	U/Emb
11301873	831995744	Azul	1	1
11301874	831996744	Negro	1	1
11301875	831997744	Rojo	1	1

Bellas Artes



Bloc de dibujo basico 130g 20h

Código	Ref.	Artículo	U/Vta	U/Emb
10001467	PDA3	A3	1	1
10001468	PDA4	A4	1	1



Bloc de dibujo acuarela grano medio 340g 12h

Código	Ref.	Artículo	U/Vta	U/Emb
10001465	ACA3	A3	1	1
10001466	ACA4	A4	1	1

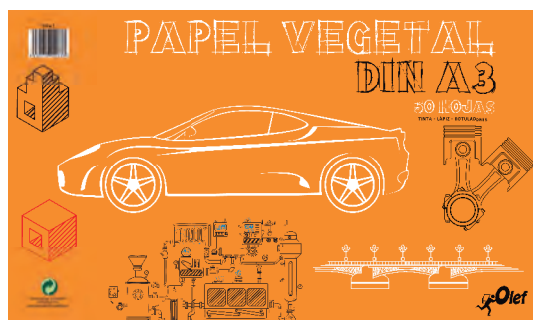

Bloc de dibujo vegetal 80g 50h

Código	Ref.	Artículo	U/Vta	U/Emb
10001463	PVA3	A3	1	1
10001464	PVA4	A4	1	1

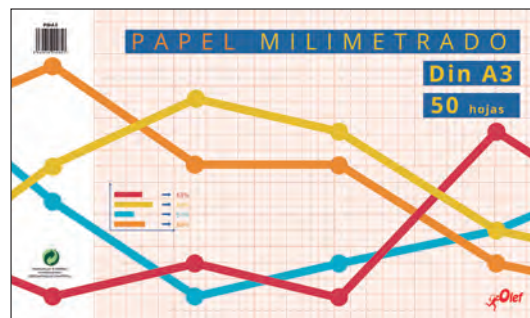

Bloc de dibujo milimetrado 80g 50h

Código	Ref.	Artículo	U/Vta	U/Emb
10001461	PMA3	A3	1	1
10001462	PMA4	A4	1	1



Portalápices plástico redondo

• *Colores opacos*

Código	Ref.	Color	U/Vta	U/Emb
24308127	PLOPAZ	Azul	1	24
24308128	PLOPBL	Blanco	1	24
30501058	PLOPCR	Cristal	1	24
30501057	PLOPGR	Gris	1	24
24308012	PLOPNE	Negro	1	24
30501067	PLOPRO	Rojo	1	24
30501007	PLOPVE	Verde	1	24

• *Colores translúcidos*

Código	Ref.	Color	U/Vta	U/Emb
30501065	PLTRAZM	Azul mar	1	24
30501059	PLTRAZ	Azul	1	24
30501063	PLTRFUC	Fucsia	1	24
30501066	PLTRWI	Kiwi	1	24
30501062	PLTRMAL	Malva	1	24
30501060	PLTRNA	Naranja	1	24
30501064	PLTRRO	Rojo	1	24
30501061	PLTRVE	Verde	1	24



Bandeja sobremesa

• *Colores opacos*

Código	Ref.	Color	U/Vta	U/Emb
14501023	BSOPAZ	Azul	1	10
14501050	BSOPAZM	Azul mar	1	10
14501018	BSOPBL	Blanco	1	10
14501029	BSOPBU	Burdeos	1	10
14501024	BSOPFUC	Fucsia	1	10
14501042	BSOPGR	Gris	1	10
14501039	BSOPMAL	Malva	1	10
14501064	BSOPNE	Negro	1	10
14501025	BSOPRO	Rojo	1	10
14501008	BSOPVE	Verde	1	10

• *Colores translúcidos*

Código	Ref.	Color	U/Vta	U/Emb
14501043	BSTRCR	Cristal	1	10
14501213	BSTRAM	Amarillo	1	10
14501296	BSTRAZ	Azul	1	10
14501088	BSTRFUC	Fucsia	1	10
14501305	BSTRFUM	Fume	1	10
14501095	BSTRKI	Kiwi	1	10
14501089	BSTRMAL	Malva	1	10
14501297	BSTRNA	Naranja	1	10
14501057	BSTRRS	Rojo	1	10
14501087	BSTRVE	Verde	1	10



Revistero de plástico 80mm

• *Colores opacos*

Código	Ref.	Color	U/Vta	U/Emb
11601400	REOPAZ	Azul	1	10
22601006	REOPAZM	Azul mar	1	10
22601050	REOPBL	Blanco	1	10
22601048	REOPFUC	Fucsia	1	10
11601402	REOPGR	Gris	1	10
22601047	REOPKI	Kiwi	1	10
22601049	REOPMAL	Malva	1	10
11601403	REOPNE	Negro	1	10
11601404	REOPRO	Rojo	1	10
11601405	REOPVE	Verde	1	10

• *Colores translúcidos*

Código	Ref.	Color	U/Vta	U/Emb
11601445	RETRCR	Cristal	1	10
11601558	RETRAZ	Azul	1	10
22601057	RETRAZM	Azul mar	1	10
22601053	RETRFUC	Fucsia	1	10
22601056	RETRFUM	Fume	1	10
22601055	RETRKI	Kiwi	1	10
22601052	RETRMAL	Malva	1	10
11601559	RETRNA	Naranja	1	10
22601054	RETRRO	Rojo	1	10
22601051	RETRVE	Verde	1	10



Papelera de plástico cerrada, 16 litros

• *Colores opacos*

Código	Ref.	Color	U/Vta	U/Emb
14401038	POPAG	Azul	1	10
14401025	POPGR	Gris	1	10
14401024	POPNE	Negro	1	10
14401037	POPRO	Rojo	1	10
14401035	POPVE	Verde	1	10

• *Colores translúcidos*

Código	Ref.	Color	U/Vta	U/Emb
14401285	PTRAZ	Azul	1	10
14401260	PTRAZM	Azul mar	1	10
14401251	PTRCR	Cristal	1	10
14401189	PTRFUC	Fucsia	1	10
14401313	PTRKI	Kiwi	1	10
14401045	PTRMAL	Malva	1	10
14401065	PTRNA	Naranja	1	10
14401064	PTRRO	Rojo	1	10
14401063	PTRVE	Verde	1	10

CUADERNOS Y EUROPEANBOOKS



Bloc tapa blanda espiral 80h con margen 60g

Código	Ref.	Formato	Rayado	U/Vta	U/Emb
10001161	100430103	4º	4x4	10	80
10001162	100430104	4º	Horizontal	10	80
10001336	100430109	4º	Pauta 3	10	80
10001338	100430112	4º	Pauta 3,5	10	80
10002167	100430100	Fº	liso	10	40
10002231	100430102	Fº	4x4	10	40
10002232	100430107	Fº	Horizontal	10	40
10010101	100430106	Fº	Pauta 3	10	40
10010102	100430113	Fº	Pauta 3,5	10	40



**Bloc Europeanbook tapas extradura A4+ 60g
120h + 40h GRATIS Cuadrícula 5x5**

Código	Ref.	U/Vta	U/Emb
10013698	100430093	5	15



Cuaderno tapa dura espiral 80h con margen 60g

Código	Ref.	Formato	Rayado	U/Vta	U/Emb
10012075	100430081	4º	Cuadrícula 4x4	5	70
10012076	100430070	4º	Horizontal	5	70
10012078	100430071	4º	Pauta 3	5	70
10001031	100430083	Fº	Cuadrícula 3x3	5	35
10016078	100430066	Fº	Cuadrícula 4x4	5	35
10012071	100430068	Fº	Horizontal	5	35
10012074	100430069	Fº	Pauta 3	5	35
10012072	100430064	Fº	Liso	5	35



Bloc Status Fº 100h 70g tapa extradura espiral con margen colores surtidos

Código	Ref.	U/Vta	U/Emb
10012085	400042281	5	25



**Cuaderno Espiral Status tapa dura 80h con margen 70g
4 colores surtidos**

Código	Ref.	Formato	Rayado	U/Vta	U/Emb
10001443	400088604	4º	Cuadrícula 4x4	5	60
10001446	400088607	Fº	Cuadrícula 4x4	5	30



**Bloc A4 80h 80g microperforado tapa blanda cuadrícula 5x5
PACK 4+1**

Código	Ref.	U/Vta	U/Emb
10012471	400058201	1	8



Bloc Plus tapa PP 80h 90 gramos
Colores surtidos

Código	Ref.	Formato	Rayado	U/Vta	U/Emb
10002569	400133613	4º	Cuadrícula 4x4	5	50
10002570	400133614	4º	Horizontal	5	50
10002571	400133616	4º	Pauta 2,5	5	50
10002572	400133617	4º	Pauta 3,5	5	50
10002573	400133618	4º	Liso	5	50
10002574	400133619	4º	Cuadrícula 3x3	5	50
10002575	400137332	4º	Cuadrícula 5x5	5	50
10002576	400133583	Fº	Cuadrícula 4x4	5	25
10002577	400133584	Fº	Horizontal	5	25
10002578	400133586	Fº	Pauta 2,5	5	25
10002579	400133587	Fº	Pauta 3,5	5	25
10002580	400133589	Fº	Liso	5	25
10002581	400133610	Fº	Cuadrícula 3x3	5	25
10002582	400137331	Fº	Cuadrícula 5x5	5	25



Bloc Plus Pastel tapa PP 80h 90 gramos
Cuadrícula 4x4 con margen
5 colores surtidos

Código	Ref.	Formato	U/Vta	U/Emb
10002681	400150288	4º	5	5
10002682	400150287	Fº	5	5

RECAMBIOS Y BLOCS



Bloc de notas microperforado con tapa 80h 60g

Código	Ref.	Formato	Rayado	U/Vta	U/Emb
10014020	100101125	A7	liso	10	80
10014019	100105346	A7	4x4	10	80
10014018	100105158	A6	liso	10	40
10014017	100101102	A6	4x4	10	40
10014016	100102716	A5	liso	5	40
10014015	100102763	A5	4x4	5	40
10014414	400032071	A4	liso	5	20
10014013	400032069	A4	4x4	5	20



Recambio A4 100h 90g
4 taladros

Código	Ref.	Rayado	U/Vta	U/Emb
25401623	400173748	Cuadrícula 4x4	1	24
25401624	400173749	Horizontal	1	24
25401625	400173990	Pauta 2,5	1	24
25401626	400173993	Pauta 3,5	1	24
25401627	400173991	Milimetrado	1	24
25401628	400173992	Liso	1	24



Papel A4 100h 80g

Código	Ref.	Rayado	U/Vta	U/Emb
12701007	100430061	Liso	30	30
12701487	100430062	Cuadrícula 4x4	30	30



Bloc de notas 80h 60g sin tapa

Código	Ref.	Formato	Rayado	U/Vta	U/Emb
10010057	100103263	A7	liso	10	80
10010058	100103760	A7	4x4	10	80
10010052	100100162	A6	liso	10	40
10010054	100104236	A6	4x4	10	40
10010047	100102166	A5	liso	5	40
10010050	100104572	A5	4x4	5	40



Bloc de dibujo La Pajarita A4 20h 120g
microperforado con espiral

Código	Ref.	Artículo	U/Vta	U/Emb
10003066	100302787	Liso	10	40
10003014	100302789	Con recuadro	10	40



Bloc school tapa blanda 80h 90g
Colores surtidos

Código	Ref.	Formato	Rayado	U/Vta	U/Emb
10001310	100430166	4º	4x4	5	60
10001311	100430167	4º	Horizontal	5	60
10001232	100430601	4º	Liso	5	60
10016079	100430171	Fº	4x4	5	30
10002222	100430172	Fº	Horizontal	5	30
10001233	100430175	Fº	Liso	5	30



Bloc School Fº 80h 90g tapa blanda
Cuadrícula 4x4 con margen
Pack 4+1

Código	Ref.	Color	U/Vta	U/Emb
10019031	400027271	Col. vivos	1	6
10001258	400072719	Col. tendencia	1	6

Bloc School Fº 80h 90g tapas extradura,
cuadrícula 4x4 con margen
Pack 4+1 colores tendencia

Código	Ref.	U/Vta	U/Emb
10019060	400122766	1	5



Bloc School Fº 80h 90g tapas extraduras
Pack 4+1

Código	Ref.	Artículo	Color	U/Vta	U/Emb
10016088	100430276	Milimetrado	Vivos	1	5
10016073	400122761	Cuadríc.4x4	Vivos	1	5
10003224	400172032	Horizontal	Vivos	1	5
10002890	400159802	Cuadríc.4x4	Pastel	1	5



Bloc Fº School Classic tapa PP 80h 90g
Cuadrícula 4x4 con margen
Pack de 5

Código	Ref.	Artículo	U/Vta	U/Emb
10001418	400091365	Col. vivos	1	5
10001419	400091366	Col. tendencia	1	5



Bloc School Classic Fº tapa PP 80h de 90g
cuadrícula 4x4 con margen

Código	Ref.	Color	U/Vta	U/Emb
10001561	400093619	Lima	5	25
10001562	400079660	Rojo	5	25
10001563	400079664	Fucsia	5	25
10001564	400079661	Verde	5	25
10001565	400093618	Azul marino	5	25
10001566	400079665	Naranja	5	25
10001567	400079662	Aqua	5	25
10001568	400106965	Azul turquesa	5	25
10001569	400106963	Violeta	5	25
10001570	400106964	Rosa chicle	5	25



Bloc School Classic 80h 90g
tapa polipropileno
Colores surtidos

*10002223: Colores vivos. 10001423: Colores tendencia.

• Cuadrícula 4x4

Código	Ref.	Formato	Rayado	U/Vta	U/Emb
10002223	400042147	Fº	Cuadríc. 4x4	5	25
10001423	400088603	Fº	Cuadríc. 4x4	5	25
10001264	400044180	4º	Cuadríc. 4x4	5	50

• Horizontal

Código	Ref.	Formato	U/Vta	U/Emb
10001262	400042148	Fº	5	25



Carpebloc Europeanbinder A4 4 anillas mixtas 35mm
con recambio 100 hojas cuadrícula 5x5

Código	Ref.	Color	U/Vta	U/Emb
10401815	400106676	Col. Clásicos	10	10
10401816	400109184	Turquesa	1	4
10401817	400109185	Rosa chicle	1	4
10401819	400109186	Rojo	1	4
10401820	400109180	Ice mint	1	4
10401821	400109187	Verde	1	4
10401822	400109181	Azul	1	4
10401823	400109182	Negro	1	4
10401824	400109183	Malva	1	4
10401825	400109188	Fucsia	1	4
10403301	400132986	Melocotón	1	4
10403302	400132987	Blanco	1	4
10401050	400075372	5 col. tendencia	1	10



EUROPEANBOOK
1 ASIGNATURA

Bloc Europeanbook A5+
tapa extradura microperforado 80h 90g
Cuadrícula 5x5. 4 colores surtidos

Código	Ref.	U/Vta	U/Emb
10001032	400053289	5	30



Bloc Japandi Europeanbook A6+ 80h 90g
microperforado tapa extradura liso
4 colores surtidos

Código	Ref.	U/Vta	U/Emb
10003219	400172270	5	20

Carpebloc School Japandi Europeanbinder A4+
4 anillas mixtas 35mm tapa extradura
Recambio 100h Cuadrícula 5x5
4 colores surtidos

Código	Ref.	U/Vta	U/Emb
10403975	400171448	5	20

Bloc Japandi Europeanbook 120h 90g
microperforado tapa extradura
cuadrícula 5x5
4 colores surtidos

Código	Ref.	Tamaño	U/Vta	U/Emb
10003217	400171356	A4+	5	15
10003218	400171357	A5+	5	20



Portatodo Kangoo Japandi
cuadrado pequeño
4 colores surtidos

Código	Ref.	U/Vta	U/Emb
11302084	400172154	1	12



Monedero plano Japandi
4 colores surtidos

Código	Ref.	U/Vta	U/Emb
11302085	400173279	4	92



Expositor Japandi de 27

Código	Ref.	U/Vta	U/Emb
18901444	400173391	1	1

5x Bloc eu. Book A4+ 120h 5x5
5x Bloc eu. Book A5+ 120h 5x5
5x Bloc eu. Book A6+ 80h liso
4x Carpebloc A4+ 100h 5x5
4x Portatodo cuadrado pequeño
4x Monedero plano



Bloc Animal Print Europeanbook 120h 90g
microperforado tapa extradura cuadrícula 5x5
3 colores surtidos

Código	Ref.	Tamaño	U/Vta	U/Emb
10003220	400171444	A4+	5	15
10003221	400171445	A5+	5	20



Carpebloc Animal Print Europeanbinder A4+
4 anillas mixtas 35mm tapa extradura
Recambio 100h Cuadrícula 5x5
3 colores surtidos

Código	Ref.	U/Vta	U/Emb
10403976	400171447	5	20



Expositor Animal Print de 19

Código	Ref.	U/Vta	U/Emb
18901445	400172361	1	1

5x Bloc eu. Book A4+ 120h 5x5
5x Bloc eu. Book A5+ 120h 5x5
6x Carpebloc A4+ 100h 5x5
5x Portatodo cuadrado pequeño



Bloc Ice Explorer Europeanbook 120h 90g
microperforado tapa extradura cuadrícula 5x5
2 colores surtidos

Código	Ref.	Tamaño	U/Vta	U/Emb
10003222	400171302	A4+	5	15
10003223	400171303	A5+	5	20

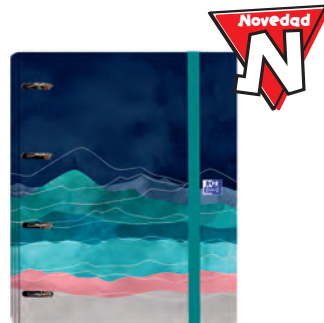

Carpebloc Ice Explorer Europeanbinder A4+
4 anillas mixtas 35mm tapa extradura
Recambio 100h Cuadrícula 5x5
2 colores surtidos

Código	Ref.	U/Vta	U/Emb
10403977	400171446	10	10



Expositor Ice Explorer de 16

Código	Ref.	U/Vta	U/Emb
18901446	400171677	1	1

5x Bloc eu. Book A4+ 120h 5x5
5x Bloc eu. Book A5+ 120h 5x5
4x Carpebloc A4+ 100h 5x5
2x Botella termo 50cl



Bloc Live&Go tapa PP 90g microp. cuadrícula 5x5

5 colores surtidos

*10002670 - 50% hojas gratis



Bloc Live&Go Europeanbook 1 A4+ 80h 90g tapa PP microperforado cuadrícula 5x5

Código	Ref.	Tamaño	Artículo	Color	U/Vta	U/Emb
10003226	400174037	A6+	Europeanbook 4 - 120h	Pastel	5	20
10002670	400149424	A5+	Europeanbook 4 - 120h	Vivos	5	20
10003230	400166695	A5+	Europeanbook 4 - 120h	Pastel	5	20
10002676	400149423	A4+	Europeanbook 8 - 160h	Vivos	5	15
10002900	400158956	A4+	Europeanbook 8 - 160h	Pastel	5	15

Código	Ref.	Color	U/Vta	U/Emb
10002671	400149420	Aqua	5	25
10002672	400149358	Azul marino	5	25
10002673	400149422	Melocotón	5	25
10002674	400149359	Rojo	5	25
10002675	400149421	Verde	5	25

Gama Live&Go Expositor surtido de 18

Código	Ref.	U/Vta	U/Emb
18901383	400160681	1	1



Carpeta fundas Live&Go A4 espiral PP con goma

Código	Ref.	Artículo	Color	U/Vta	U/Emb
15302709	400146211	20 fundas	Surtido col. vivos	10	10
15302710	400146212	20 fundas	Surtido col. pastel	10	10
15302711	400146213	20 fundas	Azul marino	10	10
15302712	400146215	20 fundas	Rosa chicle	10	10
15302713	400146217	30 fundas	Surtido col. vivos	10	10
15302714	400146218	30 fundas	Surtido col. pastel	10	10
15302743	400160223	30 fundas	Negro	10	10
15302715	400146223	40 fundas	Surtido col. vivos	10	10
15302716	400146224	40 fundas	Surtido col. pastel	10	10
15302717	400146225	40 fundas	Azul marino	10	10
15302718	400146227	40 fundas	Rosa chicle	10	10

Carpeta de gomas y solapas Live&Go A4 polipropileno 5 colores surtidos

Código	Ref.	Artículo	U/Vta	U/Emb
10403555	400146207	Col. vivos	10	10
10403556	400146208	Col. pastel	10	10
10403713	400160221	Negro	10	10



Archivador palanca Live&Go A4+ Polyfoam 70mm 5 colores surtidos

Código	Ref.	Color	U/Vta	U/Emb
11601980	400146206	Vivos	5	5
11602068	400160092	Pastel	5	5



Carpebloc Europeanbinder Polyfoam A4+ 4 anillas mixtas 35mm con recambio 100h cuadrícula 5x5

Código	Ref.	Color	U/Vta	U/Emb
10402564	400119071	Negro	4	4
10403309	400131298	Azul marino	4	4
10403310	400131302	Ice mint	4	4
10403311	400131303	Rosa chicle	4	4
10403312	400131304	Rojo	4	4
10403701	400160535	Verde manzana	4	4
10403702	400160536	Aqua	4	4
10403703	400160537	Azul pastel	4	4
10403704	400160538	Malva pastel	4	4



Carpebloc School Europeanbinder Polyfoam A5+ 4 anillas mixtas 35mm con recambio 100h Dots 5 colores pastel surtidos

Código	Ref.	U/Vta	U/Emb
10403989	400174550	10	10

Código	Ref.	Rayado	Color	U/Vta	U/Emb
10402563	400146174	Cuadrícula 5x5	5 col. vivos	10	10
10403554	400146175	Cuadrícula 5x5	5 col. pastel	10	10
10403313	400146210	Horizontal	5 col. vivos	10	10
10403700	400160744	Horizontal	5 col. pastel	10	10



Bloc Oxford&You Europeanbook 1 A4+ 80h 90g
tapa extra dura microperforado cuadrícula 5x5

Código	Ref.	Color	U/Vta	U/Emb
10002664	400149494	Banana	5	25
10002665	400149496	Pure grey	5	25
10002666	400149495	Mint green	5	25
10002667	400149492	Periwinkle blue	5	25
10002668	400149493	Watermelon	5	25
10002896	400159031	Negro	5	25
10002897	400158918	Azul petróleo	5	25
10002898	400158919	Verde militar	5	25
10002899	400159030	Burdeos	5	25

Bloc Oxford&You Europeanbook A5+ 80h 90g
tapa extra dura microperforado liso
5 colores surtidos

Código	Ref.	U/Vta	U/Emb
10002663	400149498	5	30

Bloc Oxford&You Europeanbook 5 A4+ 120h 90g
tapa extra dura microperforado cuadrícula 5x5
50% hojas gratis - 5 colores surtidos

Código	Ref.	U/Vta	U/Emb
10002669	400149497	5	15



Bloc Oxford&You Europeanbook 5 120h 90g
tapa extradura microperforado cuadrícula 5x5
Colores neutros surtidos

Código	Ref.	Artículo	U/Vta	U/Emb
10002893	400159032	A4+	5	15
10002894	400159033	A5+	5	20



Carpeta de anillas Oxford&You A4+ cartón forrado
5 colores surtidos

• 4 anillas mixtas 25mm - lomo de 40mm

Código	Ref.	Color	U/Vta	U/Emb
10403708	400153671	Vivos	10	10
10403709	400159140	Negro	10	10

• 4 anillas mixtas 40mm - lomo de 60mm

Código	Ref.	Color	U/Vta	U/Emb
10403710	400153664	Vivos	10	10
10403711	400159141	Negro	10	10



Carpebloc Oxford&You A4+ 4 anillas mixtas 35mm
recambio de 100h cuadrícula 5x5

Código	Ref.	Color	U/Vta	U/Emb
10403695	400158627	Periwinkle blue	4	4
10403696	400158628	Mint	4	4
10403697	400158629	Watermelon	4	4
10403698	400158660	Banana	4	4
10403699	400158661	Gris	4	4
10403552	400149415	5 colores surtidos	1	10

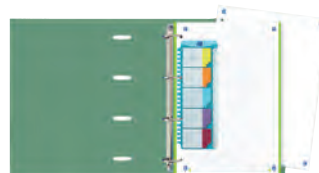

Carpebloc Oxford&You A4+
4 anillas mixtas 35mm
recambio de 100h
4 colores neutros surtidos

Código	Ref.	Rayado	U/Vta	U/Emb
10403706	400158870	Cuadrícula 5x5	1	10
10403707	400159887	Horizontal	1	10



Clasificador acordeón Oxford&You A4+ cartón forrado
12 departamentos
5 colores surtidos

Código	Ref.	U/Vta	U/Emb
10301775	400159035	10	10



Archivador palanca Oxford&You A4+ 70mm
5 colores surtidos pastel

Código	Ref.	U/Vta	U/Emb
11602088	400153670	10	10



5x 400159033 Europeanbook 4 A5+
5x 400159032 Europeanbook 5 A4+
6x 400158870 Carpebloc A4+
5x 400159978 estuche cuadrado

Gama Oxford&You colores neutros
Expositor surtido de 21

Código	Ref.	U/Vta	U/Emb
18901384	400159034	1	1



Bloc Touch Europeanbook 1 A4+ 80h 90g microperforado tapa extradura cuadrícula 5x5

Código	Ref.	Color	U/Vta	U/Emb
10001240	400075551	Lima	5	25
10001242	400075553	Aqua intenso	5	25
10001575	400107010	Azul bebé	5	25
10001822	400117272	Flamingo pastel	5	25
10001823	400117273	Malva pastel	5	25
10001824	400117274	Ice mint pastel	5	25
10001572	400106997	Rojo carmin	5	25



Bloc Touch Europeanbook 5 A5+ 120h 90g microperforado tapa extradura cuadrícula 5x5 5 colores surtidos

Código	Ref.	U/Vta	U/Emb
10001236	400138670	5	20



Bloc Touch Europeanbook microperforado 120h 90g Tapa extradura

Código	Ref.	Tamaño	Rayado	U/Vta	U/Emb
10002258	400133561	A5+	Cuadrícula 5x5	5	2
10002260	400133562	A4+	Cuadrícula 5x5	5	15
10001238	400075564	A4+	Horizontal	5	15



Carpebloc School Touch Europeanbinder A4 4 anillas mixtas 35mm con recambio 100 hojas cuadrícula 5x5

Código	Ref.	Color	U/Vta	U/Emb
10403304	400136663	Menta	4	4
10403305	400136664	Aqua	4	4
10403306	400136665	Denim	4	4
10403307	400136666	Carmin	4	4
10403308	400136662	Lima	4	4
10403109	400127153	Ice mint pastel	4	4
10403108	400127152	Azul pastel	4	4
10403111	400127155	Lavanda pastel	4	4
10403110	400127154	Flamingo pastel	4	4
10403112	400127156	Fucsia pastel	4	4
10401360	400136667	Col. vivos surt.	1	10
10402912	400119130	Col. pastel surt.	1	10



Bloc Touch Europeanbook 10 A4+ 150h 90g microperforado tapa extradura cuadrícula 5x5 5 colores pastel surtidos

Código	Ref.	U/Vta	U/Emb
10003233	400174116	5	15



Bloc Touch Europeanbook Dots A4+ 80h 90g tapa extradura

Código	Ref.	U/Vta	U/Emb
10003225	400149005	5	25



Bloc Live&Go Europeanbook 8 A5+ 160h 90g tapa PP, cuadrícula 5x5 Negro

Código	Ref.	U/Vta	U/Emb
10002901	400158957	5	16



Bloc Live&Go Europeanbook 8 A4+ 160h 90g tapa PP, cuadrícula 5x5 Color negro

Código	Ref.	U/Vta	U/Emb
10001414	400088489	5	15

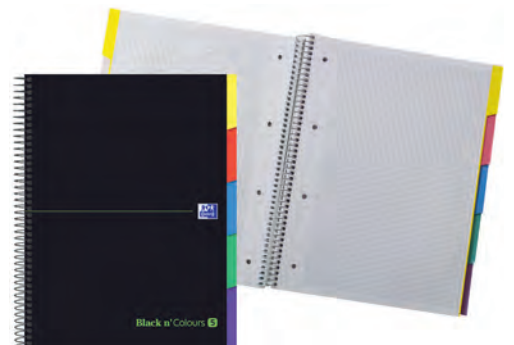

Bloc Student Black N' Colors European Book 5 90g A4+ 100h tapa extradura cuadrícula 5x5 con pestañas troqueladas

Código	Ref.	U/Vta	U/Emb
10001449	400088331	5	20



OPTIK PAPER
La tinta no irraspaa



Recuadro y espiral a juego con la tapa. Un color para cada asignatura.

Bloc Europeanbook 1 A4+ 80h 90g
tapa extradura microperforado, cuadrícula 5x5

Código	Ref.	Color	U/Vta	U/Emb
10012060	100430199	Verde flúor	5	25
10012144	400040983	Verde menta	5	25
10012120	400028276	Azul turquesa	5	25
10012058	100430197	Azul	5	25
10012068	100430269	Negro	5	25
10012062	100430201	Lila	5	25
10012145	400040984	Rosa chicle	5	25
10012069	100430270	Fucsia	5	25
10012059	100430198	Rojo	5	25
10001724	400119096	Melocotón	25	25
10012061	100430200	Amarillo	5	25
10001725	400117449	Blanco	25	25
10001234	400077053	Expositor 25 (Col. cálidos)	1	1
10001235	400077054	Expositor 25 (Col. fríos)	1	1



Bloc School Europeanbook 10 A4+ 150h 90g
Tapa extradura microperforado cuadrícula 5x5
4 colores surtidos

Código	Ref.	U/Vta	U/Emb
10001706	400118931	15	15



Bloc 10 A4+ 150h 90g
tapa extradura microperforado
cuadrícula 5x5

Código	Ref.	Color	U/Vta	U/Emb
10003231	400172360	Negro	5	15
10003232	400151482	Rojo	5	15



IDEAL PARA ABP
(Aprendizaje Basado en Proyectos)
Codiseñado con profesores

CON PIZARRA EXTRAÍBLE



Bloc School Classic Write&Erase
Europeanbook 4 A4+ 120h 90g
tapa extradura microperforado
Cuadrícula 5x5
4 colores surtidos

Código	Ref.	U/Vta	U/Emb
10001820	400120643	5	15



Bloc School Europeanbook 5 100h 90g
Cuadrícula 5x5 con pestañas troqueladas
Tapa extradura microperforado
4 colores surtidos

Código	Ref.	Tamaño	U/Vta	U/Emb
10002585	400135621	A4+	10	10
10002586	400135623	A5+	10	10



Bloc School Europeanbook 5 A4+ 120h 90g
tapa extradura microperforada cuadrícula 5x5
50% hojas gratis

Código	Ref.	Color	U/Vta	U/Emb
10003228	400151480	Rojo	5	15
10003229	400151429	Ice Mint	5	15



Bloc Europeanbook 5 A4 120h 90g microperforado
tapa extradura cuadrícula 5x5
50% hojas gratis

Código	Ref.	U/Vta	U/Emb
10016091	100430279	5	15



Bloc Europeanbook 5 A4 120h 90g tapa extradura microperforado
cuadrícula 5x5. 50% hojas gratis

Código	Ref.	Color	U/Vta	U/Emb
10001259	400073042	Tendencia	5	15
10002891	400158600	Negro	5	15

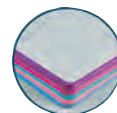

5 colores de recuadros de colores tendencia





OPTIK PAPER
La tinta no respasa



Bloc Europeanbook 4 A4+ 120h 90g tapas extraduras 3 separadores extraíbles. 50% hojas gratis

Código	Ref.	Rayado	U/Vta	U/Emb
10019035	400027275	5x5	5	15

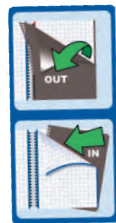

Bloc Europeanbook 4 A5+ 120h 90g cuadrícula 5x5 50% hojas gratis

Código	Ref.	Tapas	U/Vta	U/Emb
10019033	400027274	Plástico	5	20
10019023	100430568	Extraduras	5	20



Bloc Europeanbook 5 A4 120h 90g tapa PP cuadrícula 5x5 50% hojas gratis

Código	Ref.	U/Vta	U/Emb
10012065	100430278	5	15



Bloc Europeanbook 4 A4+ 120h 90g tapa PP cuadrícula 5x5 con separadores. 50% hojas gratis

Código	Ref.	U/Vta	U/Emb
10019034	400027277	5	15



Libreta grapada tapas blandas 48h 90g

Código	Ref.	Tamaño	Rayado	U/Vta	U/Emb
20901080	100105702	A5	Cuad. 4x4	10	40
20901092	100105701	A5	Cuad. 5x5	10	40
20901093	100105714	A5	Cuad. 6x6	10	40
20901128	100105715	A5	Cuad. 8x8	10	40
20901081	100105709	A5	Horizontal	10	40
20901090	100105713	A5	Pauta 2,5	10	40
20901095	100105716	A5	Pauta 3,5	10	40
20901105	100105717	A5	Montess. 5cm	10	40
20901125	100102926	A4	Liso	10	40
20901079	100101228	A4	Cuad. 4x4	10	40
20901109	100104459	A4	Cuad. 5x5	10	40
20901098	100103428	A4	Horizontal	10	40
20901099	100100202	A4	Pauta 2,5	10	40
20901101	100102899	A4	Pauta 3,5	10	40
20901096	100103418	A4	Milimetrado	10	40



Libreta grapada School Openflex 48h 90g 90g tapa polipropileno Colores surtidos

Código	Ref.	Tamaño	Rayado	U/Vta	U/Emb
20901617	400019577	9x14	Cuad. 5x5	10	40
20901075	400073339	A5	Pauta 2,5	10	40



Libreta grapada School Easybook 48h cuadrícula 4x4 Colores surtidos

Código	Ref.	Tamaño	Colores	U/Vta	U/Emb
20902174	400172933	A5	Pastel	10	40
20902175	400172931	A4	Vivos	10	40
20902176	400172932	A4	Pastel	10	40



Libreta grapada School Openflex 48h 90g tapa polipropileno Colores surtidos

Código	Ref.	Tamaño	Rayado	U/Vta	U/Emb
20901104	400073335	A4	Horizontal	10	40
20901043	400073337	A5	Horizontal	10	40
20901708	400061067	A4	Liso	10	40
20901940	400161059	A5	Liso	10	40
20901641	400073336	A4	Pauta 3,5	10	40
20901074	400073338	A5	Pauta 3,5	10	40
20902140	400009125	A4	Cuad. 5x5	10	40



Libreta grapada School Openflex 48h 90g tapa polipropileno cuadrícula 4x4

Código	Ref.	Tamaño	Color	U/Vta	U/Emb
20901976	100735871	A4	Rojo	10	40
20901978	100735873	A4	Lima	10	40
20901979	100735874	A4	Verde	10	40
20901980	100735875	A4	Azul	10	40
20901189	400026393	A4	Surtido	10	40
20901188	400026392	A5	Surtido	10	40



Carpeta de gomas y solapas Urban A4+ PP traslúcido con etiqueta. 8 colores surtidos

Código	Ref.	U/Vta	U/Emb
10401809	400147020	10	10



Carpeta de anillas Urban PP traslúcido A4 8 colores surtidos

Código	Ref.	Anillas	U/Vta	U/Emb
10401805	400147041	2 anillas 15mm	10	10
10401807	400147046	2 anillas 30mm	10	10
10403557	400147047	4 anillas 30mm	10	10



Carpeta de proyectos Urban PP traslúcido A4+ gomas 8 colores surtidos

Código	Ref.	Lomo	U/Vta	U/Emb
10401812	400146969	25mm	10	10
10401811	400146995	40mm	10	10



Carpeta fundas Urban PP traslúcido A4 8 colores surtidos

Código	Ref.	Fundas	U/Vta	U/Emb
15302719	400146996	20	10	10
15302404	400146997	30	10	10
15302119	400147011	40	10	10
15302120	400147012	60	10	10
15302720	400147084	80	10	10
15302721	400147085	100	10	10



Carpeta fundas espiral Urban PP traslúcido A4 8 colores surtidos

Código	Ref.	Fundas	U/Vta	U/Emb
15302121	400147016	20	10	10
15302406	400147013	30	10	10
15302122	400147014	40	10	10
15302123	400147015	60	10	10



Clasificador acordeón gomas Urban PP traslúcido A4+ 5 colores surtidos

Código	Ref.	Dptos	U/Vta	U/Emb
10301667	400147018	13	10	10
10301666	400147019	8	10	10



Dossier clip Urban PP traslúcido A4 pinza plástico 30h 5 colores surtidos

Código	Ref.	U/Vta	U/Emb
18001655	400147040	10	100



Dossier sobre broche Urban PP traslúcido 5 colores surtidos

Código	Ref.	Artículo	U/Vta	U/Emb
18001725	400147030	A3	10	50
18001656	400147022	A4	50	50
18001726	400147025	A5	10	50
18001727	400147028	A6	10	50
18001728	400147029	DL (recibos)	10	50



Dossier sobre velcro PP traslúcido multitaladro 6 colores surtidos

Código	Ref.	Tamaño	U/Vta	U/Emb
18001870	400113412	A4	15	15
18001927	400170115	A5+	24	24



Carpeta de gomas y solapas A4 cartón Top File Pack de 10 colores clásicos

Código	Ref.	U/Vta	U/Emb
10401373	400114319	1	5



Carpeta de gomas y solapas A4 cartón Top File Pack de 10 colores pastel

Código	Ref.	U/Vta	U/Emb
10403990	400117805	1	5



Funda multitaladro A4 Quick'in, 11 taladros 50µ, PP transparente Paquete de 50

Código	Ref.	U/Vta	U/Emb
19801464	400078667	1	20



Recambios 100h 90g 4 taladros

Código	Ref.	Formato	Rayado	U/Vta	U/Emb
25401125	100430206	4º	4x4	10	50
25401134	400173742	A4	Liso	10	24
25401130	400173743	A4	Horizontal	25	24
25401112	400173744	A4	Pauta 3,5	25	24



Recambio School A4 100+20 hojas 90g 4 taladros

Código	Ref.	Rayado	Colores	U/Vta	U/Emb
25401669	400174182	Cuadrícula 4x4	Vivos	1	20
25401565	400148310	Cuadrícula 5x5	Vivos	1	20
25401572	400146851	Cuadrícula 5x5	Pastel	1	20
25401619	400158519	Horizontal	Vivos	1	20
25401620	400159876	Horizontal	Pastel	1	20
25401621	400158168	Liso	Vivos	1	20



Recambio School Color 1 A4 100h + 20h 90gr 4 taladros, cuadrícula 5x5 (1 color en banda)

Código	Ref.	Color	U/Vta	U/Emb
25401613	400158163	Naranja	1	13
25401614	400158164	Lila	1	13
25401615	400158165	Negro	1	13
25401466	400158057	Ice mint	1	13
25401461	400158058	Turquesa	1	13
25401463	400158059	Verde	1	13
25401616	400158160	Lima	1	13
25401465	400158161	Rosa chicle	1	13
25401464	400158162	Rojo	1	13
25401668	400174181	Fucsia	1	13



Recambio School A4 4 taladros 90g cuadrícula 4x4 con margen

Código	Ref.	Artículo	U/Vta	U/Emb
25401113	400058179	100+20 hojas	1	20
25401493	400119437	200+50 hojas	10	10



Recambio Color 10 A4 160h 90g 4 taladros cuadrícula 5x5

Código	Ref.	U/Vta	U/Emb
25401467	400106627	15	15



Recambio School Dots A4 100h 90gr 4 taladros (5 colores pastel en banda)

Código	Ref.	U/Vta	U/Emb
25401672	400162337	17	17



Recambio School Dots A4 80h 90gr 6 taladros

Código	Ref.	U/Vta	U/Emb
25401671	400173651	20	20



Recambio A4 200+50 hojas 90g 4 taladros cuadrícula 5x5. 5 colores en banda

Código	Ref.	Colores	U/Vta	U/Emb
25401573	400150903	Vivos	1	10
25401670	400173020	Pastel	1	10



Recambio Color 1 A4 encolado 80h de 90g cuadrícula 5x5, 4 taladros (1 color de recuadro)

Código	Ref.	Artículo	U/Vta	U/Emb
25401026	400123682	Morado	5	20
25401169	400123675	Amarillo	5	20
25401166	400123672	Azul	5	20
25401227	400123679	Azul turquesa	5	20
25401176	400123677	Fucsia	5	20
25401492	400121584	Melocotón	5	20
25401175	400123678	Negro	5	20
25401167	400123673	Rojo	5	20
25401247	400123681	Rosa chicle	5	20
25401168	400123674	Verde fluo	5	20
25401248	400123680	Verde menta	5	20
25401170	400123676	Lila	5	20
25401491	400121559	Blanco	5	20
25401031	400077055	Exp. 25 (Col. cálidos)	1	1
25401032	400077056	Exp. 25 (Col. fríos)	1	1



Separadores A4 4 taladros Colores surtidos

Código	Ref.	Artículo	Color	U/Vta	U/Emb
20401194	400159036	5 pestañas	5 vivos	1	25
20401195	400159037	5 pestañas	5 pastel	1	25
20401196	400159038	10 pestañas	10 surtidos	1	25

BLOCS Y LÁMINAS DE DIBUJO



Lámina de dibujo A4 130gr liso
Pack de 10

Código	Ref.	U/Vta	U/Emb
10801210	400151292	1	20



Lámina acuarela y témpera 300g 6h liso
Doble cara grano fino y grueso

Código	Ref.	Artículo	U/Vta	U/Emb
10801212	400151293	A4	1	20
10801213	400151295	A3	1	20

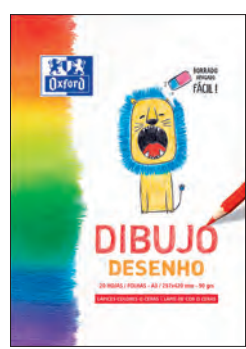

Bloc liso Kids A4 20h encolado

• *Dibujo 90gr*

Código	Ref.	U/Vta	U/Emb
10002651	400147935	1	20



• *Acuarela y témpera 300gr*

Código	Ref.	U/Vta	U/Emb
10002654	400147938	1	20



Bloc de dibujo 130gr 20h liso
microperforado espiral

Código	Ref.	Artículo	U/Vta	U/Emb
10002646	400148231	A5+	1	20
10002642	400148232	A4+	1	20
10002647	400148237	A3+	1	20



Bloc de dibujo A4+ 130gr 20h 2 taladros
microperforado espiral

Código	Ref.	Artículo	U/Vta	U/Emb
10002644	400148235	Liso	1	20
10002645	400148236	Recuadro	1	20



Bloc de dibujo A4+ 130gr 20h
con recuadro
microperforado espiral

Código	Ref.	U/Vta	U/Emb
10002643	400148234	1	20



Bloc de dibujo acuarela 300g 10h liso espiral
Doble cara grano fino y grueso

Código	Ref.	Artículo	U/Vta	U/Emb
10002648	400148238	A4+	1	20
10002649	400148239	A3+	1	20



Bloc de manualidades 42 hojas
Papeles surtidos

Código	Ref.	U/Vta	U/Emb
10002656	400147987	1	10



Bloc de manualidades cartulina de colores 170g
10 hojas

Código	Ref.	U/Vta	U/Emb
10002657	400147983	1	10



Bloc de música A4 24h
12h pentagramas y 12h cuadrícula 5x5

Código	Ref.	U/Vta	U/Emb
10009002	100105244	20	40



Bloc de música
*Bloc apaisado

Código	Ref.	Tamaño	Hojas	U/Vta	U/Emb
10009017	100104854	A5	10h - 5 pentagramas*	20	40
10001826	400118566	Fº	20h - 12 pentagramas	10	20
10009014	100302790	4º	20h - 8 pentagramas*	20	40



Bloc de dibujo cosido Artbooks esbozo liso 96h 100g

Código	Ref.	Artículo	Color	U/Vta	U/Emb
10002678	400152625	A6	4 surtidos	1	40
10002677	400152626	A6	Negro	1	40
10002680	400152621	A5	4 surtidos	1	20
10002679	400152622	A5	Negro	1	20
10002895	400152623	A4	Negro	5	10



Portatodo Kangoo
5 colores surtidos

11301940: 12x rectangular + 12x redondo



Código	Ref.	Artículo	U/Vta	U/Emb
11301890	400150280	Rectangular mediano	1	15
11301891	400150281	Redondo pequeño	1	15
11302104	400174354	Cubilete	12	12
11302102	400174240	Plano grande	1	15
11301940	400161680	Expositor de 24*	1	10



Portatodo Kangoo Live&Go Pastel
5 colores surtidos

11301941: 8x rectangular, 10x cuadrado pequeño, 4x cuadrado grande

Código	Ref.	Artículos	U/Vta	U/Emb
11301936	400159975	Rectangular mediano	5	15
11301937	400159976	Cuadrado pequeño	5	15
11301938	400159977	Cuadrado grande	5	15
11301941	400161681	Expositor de 22*	1	1



Portatodo Kangoo You cuadrado pequeño
4 colores surtidos

Código	Ref.	U/Vta	U/Emb
11301939	400159978	4	12



Portatodo Kangoo Kids
5 colores surtidos

*11301942: 5x redondo + 10x cuadrado
*11301943: 5 de cada (doble, triple, triple ovalado y cofre)

Código	Ref.	Artículos	U/Vta	U/Emb
11301893	400150283	Redondo grande	1	15
11301894	400150284	Cuadrado grande	1	15
11301895	400150285	Doble	1	15
11301935	400161345	Triple ovalado (3 cremalleras)	5	15
11301934	400161344	Cofre	5	15
11301942	400161682	Expositor de 15*	1	1
11301943	400161683	Expositor de 15*	1	1
11301897	400152382	Expositor de 105 surtido	1	1



Portatodo Kangoo Touch redondo pequeño
5 colores surtidos

Código	Ref.	U/Vta	U/Emb
11302105	400174183	12	12



Témperas en bote 20ml

Código	Ref.	Estuche	U/Vta	U/Emb
27401785	400175708	6 uds	1	12
27401786	400175709	12 uds	1	10



Plastilina en barra 15g

Código	Ref.	Estuche	U/Vta	U/Emb
24101472	400175706	6 uds	1	20
24101473	400175707	12 uds	1	12



Organizador sobremesa escalado 3x3
2 colores surtido

Código	Ref.	U/Vta	U/Emb
22501025	400175163	1	4



Organizador sobremesa en cruz 2x4
2 colores surtidos

Código	Ref.	U/Vta	U/Emb
22501027	400175164	1	4



Organizador sobremesa 3 cubiletes surtido
3 colores surtidos

Código	Ref.	U/Vta	U/Emb
22501028	400175165	1	4



Reloj de pared Calm analógico ø 25cm
(pila incluida)

Código	Ref.	Color	U/Vta	U/Emb
15701050	400173577	Lavanda	1	10
15701051	400173574	Ice Mint	1	10
15701052	400173572	Negro	1	10

Pila incluida



Lámpara sobremesa Clic

Código	Ref.	Color	U/Vta	U/Emb
15501148	400173047	Lavanda	1	12
15501149	400173046	Ice Mint	1	12
15501150	400173048	Negro	1	12



Bloc Hello Kitty Infantil con Stickers
Tapa Dura, F° Rayado, 80 hojas, 63 grs

Código	Ref.	U/Vta	U/Emb
79901027	902319	1	1



Bloc CHIC A4 140 hojas de 80gr
Microperforado. Cuadrícula 5x5

Código	Ref.	U/Vta	U/Emb
79901009	902304	1	1



Carpeta CHIC
Tapa Extra, F°, con gomas y solapas,

Código	Ref.	U/Vta	U/Emb
79904007	902293	1	1



Carpeta CHIC
Tapa Extra, F°, clasificadora

Código	Ref.	U/Vta	U/Emb
79903001	902284	1	1



Bloc Retro 80g, cuadrícula 5x5 microperforado

Código	Ref.	Artículo	U/Vta	U/Emb
79901010	902305	A4, 140h, 4 taladros	1	1
79901016	902311	A6, 100h, con funda	1	1



Bloc Dragones 80 hojas, 63g
tapa dura con stickers

Código	Ref.	Artículo	U/Vta	U/Emb
79901006	902297	A5 Rayado	1	1
79901023	902316	F° Cuadrícula 4x4	1	1
79901026	902317	F° Rayado	1	1

Laura Roig



Blocs
5 modelos surtidos

Código	Tamaño	Rayado	Hojas	U/Vta	U/Emb
29401104	8°	Cuadrícula natural	120	1	5
29401118	A4	Horizontal	100	1	5
29401119	A4	Horizontal	160	1	5

PIGNA JUNIOR



Libreta decorada 32 hojas

Código	Ref.	Artículo	U/Vta	U/Emb
20901067	321444	Cuadrícula 4	1	10
20901068	321445	Cuadrícula 6	1	10



Libreta decorada rayada 32 hojas

Código	Ref.	U/Vta	U/Emb
20901072	321475	1	10



Libreta F° decorada A4 40 hojas 60g
Cuadrícula de 5x5

Código	Ref.	U/Vta	U/Emb
20901025	107056	1	10



Bloc espiral tapa forrada 80 hojas 70g

Código	Ref.	Modelo	Cuadrovía	U/Vta	U/Emb
79800035	7FTE002A	Fº	2,5 mm azul	5	25
79800037	7FTE002N	Fº	2,5 mm naranja	5	25
79800038	7FTE002R	Fº	2,5 mm rojo	5	25
79800039	7FTE002V	Fº	2,5 mm verde	5	25
79801064	7FTE02AM	Fº	2,5 mm amarillo	5	25
79800040	7FTE003A	Fº	3 mm azul	5	25
79800042	7FTE003N	Fº	3 mm naranja	5	25
79800043	7FTE003R	Fº	3 mm rojo	5	25
79800044	7FTE003V	Fº	3 mm verde	5	25
79801034	7FTE03AM	Fº	3 mm amarillo	5	25
79801033	7FTE003S	Fº	3 mm Surtidos	5	25
79800045	7FTE004A	Fº	4 mm azul	5	25
79800047	7FTE004N	Fº	4 mm naranja	5	25
79800048	7FTE004R	Fº	4 mm rojo	5	25
79800049	7FTE004V	Fº	4 mm verde	5	25
79801035	7FTE04AM	Fº	4 mm amarillo	5	25
79801036	7FTE004S	Fº	4mm Surtidos	5	25
79800050	7CTE002A	4º	2,5 mm azul	5	40
79800051	7CTE002G	4º	2,5 mm gris	5	40
79800052	7CTE002N	4º	2,5 mm naranja	5	40
79800053	7CTE002R	4º	2,5 mm rojo	5	40
79800054	7CTE002V	4º	2,5 mm verde	5	40
79801065	7CTE02AM	4º	2,5 mm amarillo	5	40
79800055	7CTE003A	4º	3 mm azul	5	40
79800057	7CTE003N	4º	3 mm naranja	5	40
79800058	7CTE003R	4º	3 mm rojo	5	40
79800059	7CTE003V	4º	3 mm verde	5	40
79801059	7CTE03AM	4º	3 mm amarillo	5	40
79801060	7CTE003S	4º	3 mm Surtidos	5	40
79800060	7CTE004A	4º	4 mm azul	5	40
79800062	7CTE004N	4º	4 mm naranja	5	40
79800063	7CTE004R	4º	4 mm rojo	5	40
79800064	7CTE004V	4º	4 mm verde	5	40
79801061	7CTE04AM	4º	4 mm amarillo	5	40
79801062	7CTE004S	4º	4 mm Surtidos	5	40
79801028	7CTE005A	4º	5 mm azul	5	40
79801029	7CTE005G	4º	5 mm gris	5	40
79801030	7CTE005N	4º	5 mm naranja	5	40
79801031	7CTE005R	4º	5 mm rojo	5	40
79801032	7CTE005V	4º	5 mm verde	5	40
79801063	7CTE05AM	4º	5 mm amarillo	5	40



Bloc espiral tapa blanda 70g colores surtidos

Código	Ref.	Mod.	Hojas	Cuadrovía	U/Vta	U/Emb
79800031	07F002	Fº	80	2,5 mm	10	30
79800032	07F003	Fº	80	3 mm	10	30
79800033	07F004	Fº	80	4 mm	10	30
79800034	07F005	Fº	80	5 mm	10	30
79800027	07002	4º	40	2,5 mm	10	100
79800028	07003	4º	40	3 mm	10	100
79800029	07004	4º	40	4 mm	10	100
79800030	07005	4º	40	5 mm	10	100



Bloc tapa polipropileno 80 hojas 90g cuadrovía

• Fº

Código	Ref.	Cuadrovía	U/Vta	U/Emb
79801004	7FTP002A	2,5 mm amarillo	5	25
79801005	7FTP002N	2,5 mm naranja	5	25
79801006	7FTP002R	2,5 mm rosa	5	25
79801007	7FTP002V	2,5 mm verde	5	25
79801008	7FTP002B	2,5 mm azul	5	25
79801024	7FTP002S	2,5 mm surtido	5	25
79801009	7FTP003A	3 mm amarillo	5	25
79801010	7FTP003N	3 mm naranja	5	25
79801011	7FTP003R	3 mm rosa	5	25
79801012	7FTP003V	3 mm verde	5	25
79801013	7FTP003B	3 mm azul	5	25
79801025	7FTP003S	3 mm surtido	5	25
79801014	7FTP004A	4 mm amarillo	5	25
79801015	7FTP004N	4 mm naranja	5	25
79801016	7FTP004R	4 mm rosa	5	25
79801017	7FTP004V	4 mm verde	5	25
79801018	7FTP004B	4 mm azul	5	25
79801026	7FTP004S	4 mm surtido	5	25
79801019	7FTP005A	5 mm amarillo	5	25
79801020	7FTP005N	5 mm naranja	5	25
79801021	7FTP005R	5 mm rosa	5	25
79801022	7FTP005V	5 mm verde	5	25
79801023	7FTP005B	5 mm azul	5	25
79801027	7FTP005S	5 mm surtido	5	25

• 4º

Código	Ref.	Cuadrovía	U/Vta	U/Emb
79801037	7CTP002A	2,5 mm amarillo	5	40
79801038	7CTP002B	2,5 mm azul	5	40
79801039	7CTP002N	2,5 mm naranja	5	40
79801040	7CTP002R	2,5 mm rosa	5	40
79801041	7CTP002V	2,5 mm verde	5	40
79801042	7CTP002S	2,5 mm surtido	5	40
79801043	7CTP003A	3 mm amarillo	5	40
79801044	7CTP003B	3 mm azul	5	40
79801045	7CTP003N	3 mm naranja	5	40
79801046	7CTP003R	3 mm rosa	5	40
79801047	7CTP003V	3 mm verde	5	40
79801048	7CTP003S	3 mm surtido	5	40
79801049	7CTP004A	4 mm amarillo	5	40
79801050	7CTP004B	4 mm azul	5	40
79801051	7CTP004N	4 mm naranja	5	40
79801052	7CTP004R	4 mm rosa	5	40
79801053	7CTP004V	4 mm verde	5	40
79801054	7CTP004S	4 mm surtido	5	40
79801089	7CTP005A	5 mm amarillo	5	40
79801092	7CTP005B	5 mm azul	5	40
79801091	7CTP005N	5 mm naranja	5	40
79801093	7CTP005R	5 mm rosa	5	40
79801090	7CTP005V	5 mm verde	5	40
79801094	7CTP005S	5 mm surtido	5	40



Bloc espiral tapa extra dura Fº 100 hojas

Código	Ref.	Cuadrovía	U/Vta	U/Emb
79801075	7FTE103A	3 mm azul	5	20
79801076	7FTE103R	3 mm rojo	5	20
79801077	7FTE103N	3 mm naranja	5	20
79801078	7FTE103V	3 mm verde	5	20
79801079	7FTE103AM	3 mm amarillo	5	20
79801085	7FTE103S	3 mm surtido	5	20
79801080	7FTE104A	4 mm azul	5	20
79801081	7FTE104R	4 mm rojo	5	20
79801082	7FTE104N	4 mm naranja	5	20
79801083	7FTE104V	4 mm verde	5	20
79801084	7FTE104AM	4 mm amarillo	5	20
79801086	7FTE104S	4 mm surtido	5	20

5 colores en banda



Libreta grapada 50 hojas 90g Cuadrovía tapa polipropileno. 5 colores surtidos

Código	Ref.	Cuadrovía	U/Vta	U/Emb
79801071	06A4P02	2,5 mm	5	40
79801072	06A4P03	3 mm	5	40
79801073	06A4P04	4 mm	5	40
79801106	06A4P05	5 mm	5	40



Libreta grapada 50 hojas 70g Cuadrovía

• A4

Código	Ref.	Cuadrovía	U/Vta	U/Emb
79801001	06A4002	2,5 mm	10	50
79801067	06A402S	2,5 mm*	1	10
79801002	06A4003	3 mm	10	50
79801068	06A403S	3 mm*	1	10
79801003	06A4004	4 mm	10	50
79801069	06A404S	4 mm*	1	10
79801097	06A4005	5 mm	10	50

• 4°

Código	Ref.	Cuadrovía	U/Vta	U/Emb
79801055	06C002	2,5 mm	10	80
79801056	06C003	3 mm	10	80
79801057	06C004	4 mm	10	80
79801058	06C005	5 mm	10	80

*Pack de 5 colores surtidos



Cuaderno escritura magenta

Código	Ref.	Descripción	U/Vta	U/Emb
79800067	L31001	Magenta Nº1	10	250
79800068	L31002	Magenta Nº2	10	250
79800069	L31003	Magenta Nº3	10	250
79800070	L31004	Magenta Nº4	10	250
79800071	L31005	Magenta Nº5	10	250
79800072	L31006	Magenta Nº6	10	250
79800073	L31007	Magenta Nº7	10	250
79800074	L31008	Magenta Nº8	10	250
79800075	L31009	Magenta Nº9	10	250
79800076	L31010	Magenta Nº10	10	250
79800077	L31011	Magenta Nº11	10	250
79800078	L31012	Magenta Nº12	10	250
79800079	L31013	Magenta Nº13	10	250
79800080	L31014	Magenta Nº14	10	250
79800081	L31015	Magenta Nº15	10	250
79800082	L31016	Magenta Nº16	10	250
79800083	L31017	Magenta Nº17	10	250
79800084	L31018	Magenta Nº18	10	250
79800085	L31019	Magenta Nº19	10	250
79800086	L31020	Magenta Nº20	10	250
79800087	L31021	Magenta Nº21	10	250
79800088	L31022	Magenta Nº22	10	250



Libreta grapada tapa blanda 70g

Código	Ref.	Mod.	Hojas	Cuadrovía	U/Vta	U/Emb
79800116	05004	4°	16	4 mm	25	150
79800117	05005	4°	16	5 mm	25	150
79800118	05006	4° ap.	16	6 mm	25	150
79800119	05008	4° ap.	16	8 mm	25	150
79800120	06002	4°	30	2,5 mm	15	90
79800121	06003	4°	30	3 mm	15	90
79800122	06004	4°	30	4 mm	15	90
79801066	06AP04	4° ap.	30	4 mm	15	90



Recambio 100 hojas

Código	Ref.	Modelo	Cuadrovía	U/Vta	U/Emb
79800152	09002	F°	2,5 mm (4 an.)	5	25
79800153	09003	F°	3 mm (4 an.)	5	25
79800154	09004	F°	4 mm (4 an.)	5	25
79801074	09005	F°	5 mm (4 an.)	5	25
79800148	08002	4°	2,5 mm (2 y 4 an.)	10	50
79800149	08003	4°	3 mm (2 y 4 an.)	10	50
79800150	08004	4°	4 mm (2 y 4 an.)	10	50
79800151	08005	4°	5 mm (2 y 4 an.)	10	50
79800145	08006	4°	6 mm (2 y 4 an.)	10	50
79800146	08008	4°	8 mm (2 y 4 an.)	10	50



Cuaderno preescritura

Código	Ref.	Descripción	U/Vta	U/Emb
12601019	L35001	Preescritura Nº1	10	250
12601020	L35002	Preescritura Nº2	10	250
12601021	L35003	Preescritura Nº3	10	250
12601022	L35004	Preescritura Nº4	10	250
12601023	L35005	Preescritura Nº5	10	250
12601024	L35006	Preescritura Nº6	10	250



5 colores en banda

Recambio Pro multitareas A4 100h 90g 5 colores surtidos

Código	Ref.	Cuadrovía	U/Vta	U/Emb
79801087	09A403	3 mm	5	20
79801088	09A404	4 mm	5	20



Cuaderno cartilla de lectura

Código	Ref.	Descripción	U/Vta	U/Emb
79800006	L10001	Lectura Nº1	10	50
79800007	L10002	Lectura Nº2	10	50
79800008	L10003	Lectura Nº3	10	50



Bloc Basic tapa blanda, 80 hojas de 60g. 10 colores surtidos

Folio

Código	Ref.	Rayado	U/Vta	U/Emb
10002298	16418	Cuadrícula 4x4	10	30
10002729	16413	Cuadrícula 5x5	10	30
10002315	16100	Cuadrícula 3x3	10	30
10002299	16419	Horizontal	10	30
10002302	16440	Pauta 2,5 mm.	10	30
10002301	16420	Pauta 3,5 mm.	10	30
10002297	16421	Milimetrado	10	30
10001839	16423	Cuadrícula 46	10	30
10002300	16422	Liso	10	30

Cuarto

Código	Ref.	Rayado	U/Vta	U/Emb
10001368	16428	Cuadrícula 4x4	10	60
10001365	16101	Cuadrícula 3x3	10	60
10001358	16429	Horizontal	10	60
10001323	16430	Pauta 2,5 mm.	10	60
10001360	16439	Pauta 3,5 mm.	10	60
10001361	16431	Milimetrado	10	60
10001024	16307	Liso	10	60
10001367	16432	4x4 Apaisado	10	60



Bloc Xtra tapa dura, 80 hojas de 60g. 10 colores surtidos



Código	Ref.	Tamaño	Rayado	U/Vta	U/Emb
10001364	16733	4°	Cuadrícula 4x4	5	60
10001374	16736	4°	Horizontal	5	60
10001373	16737	4°	Pauta 2,5mm	5	60
10002418	16724	4°	Pauta 3,5mm	5	60
10002419	16709	4°	Cuadrícula 3x3	5	60
10002311	16220	F°	Cuadrícula 4x4	5	30
10002245	16221	F°	Horizontal	5	30
10002075	16222	F°	Pauta 2,5mm	5	30
10002416	16224	F°	Pauta 3,5mm	5	30
10002415	16233	F°	Milimetrado	5	30
10002417	16226	F°	Cuadrícula 3x3	5	30
10002320	16223	F°	Liso	5	30

Código	Ref.	Rayado	Tamaño	Color	U/Vta	U/Emb
10002018	16060	Cuadrícula 4x4	Folio	Verde	5	30
10002028	16070	Cuadrícula 4x4	Folio	Azul	5	30
10002010	16050	Cuadrícula 4x4	Folio	Amarillo	5	30
10012108	16066	Cuadrícula 4x4	Folio	Naranja	5	30
10002304	16612	Cuadrícula 4x4	Folio	Negro	5	30
10002303	16729	Cuadrícula 4x4	Folio	Rojo	5	30
10001356	16734	Cuadrícula 4x4	Cuarto	Rojo	5	60
10001359	16722	Pauta 2,5	Cuarto	Rojo	5	60
10002307	16720	Milimetrado	Folio	Rojo	5	30



Bloc Xtra Plus tapa extradura 80h 90g. 10 colores surtidos



Folio

Código	Ref.	Rayado	U/Vta	U/Emb
10002366	16283	Cuadrícula 4x4	5	25
10002367	16284	Horizontal	5	25
10002368	16285	Pauta 2,5mm	5	25
10002369	16286	Pauta 3,5mm	5	25
10002370	16288	Liso	5	25

Cuarto

Código	Ref.	Rayado	U/Vta	U/Emb
10001381	16277	Cuadrícula 4x4	5	50
10001382	16278	Horizontal	5	50
10001383	16279	Pauta 2,5mm	5	50
10001095	16244	Pauta 3,5mm	5	50
10002420	16245	Liso	5	50



Bloc First Class tapa extradura microperforada 120h 100g cuad. 5x5 Expositor de 24

Código	Ref.	U/Vta	U/Emb
10003250	E22/01	1	1



Bloc First Class tapa extradura microperforada 120h 100g cuadrícula 5x5 2 colores surtidos

Código	Ref.	Tamaño	U/Vta	U/Emb
10002912	16029	A4	4	16
10003213	16036	A5	4	24



Bloc Premium microperforado tapa extradura 160h de 70g, cuadrícula 5x5. 8 colores surtidos

Código	Ref.	Tamaño	U/Vta	U/Emb
10013016	16403	A4	4	16
10013026	16292	A5	4	24



Bloc Premium Extra microperforado tapa extradura 120h de 90g, cuadrícula 5x5. 8 colores surtidos

Código	Ref.	Tamaño	U/Vta	U/Emb
10015019	16481	A4	4	16
10001841	16480	A5	4	24





Bloc Plastipac F° tapa PP 80h 90g cuadrícula 4x4

Código	Ref.	Color	U/Vta	U/Emb
10002914	16103	Turquesa	25	25
10002915	16104	Azul oscuro	25	25
10002916	16105	Amarillo	25	25
10002917	16106	Rojo oscuro	25	25
10002918	16107	Verde claro	25	25
10003248	16110	Naranja	25	25

Bloc Plastipac tapa PP 80h 90g. 10 colores surtidos

• Folio

Código	Ref.	Rayado	U/Vta	U/Emb
10002095	16467	Cuadrícula 4x4	5	25
10001632	16468	Cuadrícula 5x5	5	25
10002256	16412	Cuadrícula 3x3	5	25
10001630	16476	C.46	5	25
10002390	16568	Milimetrado	5	25
10002364	16407	Horizontal	5	25
10002365	16408	Pauta 2,5	5	25
10001225	16566	Pauta 3,5	5	25
10002221	16567	Liso	5	25

• Cuarto

Código	Ref.	Rayado	U/Vta	U/Emb
10001298	16409	Cuadrícula 4x4	5	50
10001019	16564	Cuadrícula 5x5	5	50
10001334	16574	Cuadrícula 3x3	5	50
10001631	16565	Cuadrícula 46	5	50
10001301	16575	Milimetrado	5	50
10001300	16569	Horizontal	5	50
10001633	16570	Pauta 2,5	5	50
10001388	16572	Pauta 3,5	5	50
10001385	16573	Liso	5	50



Bloc Plastipac bolsillo tapa PP 80h 90g cuadrícula 5x5. 10 colores surtidos

Código	Ref.	Tamaño	U/Vta	U/Emb
10001313	16410	A6 Natural	5	80
10001314	16411	A7 Natural	5	150
10001703	16404	A6 Apaisado	5	80
10001704	16405	A7 Apaisado	5	150



Bloc Plastipac F° tapa PP 80h 90g cuadrícula 4x4 10 colores surtidos

Código	Ref.	U/Vta	U/Emb
10001612	16561	5	25



Especial zurdos



Bloc Plastipac microperforado tapa PP 100h 90g. 10 colores surtidos

Código	Ref.	Tamaño	Rayado	U/Vta	U/Emb
10001308	16683	A4	Cuadrícula 5x5	4	24
10001309	16684	A4	Horizontal	4	24
10002730	16686	A4	Liso	4	24
10002421	16685	A5	Cuadrícula 5x5	4	32



Bloc Pastel F° tapa PP 80h 90g cuadrícula 4x4 5 colores surtidos

Código	Ref.	U/Vta	U/Emb
10002919	16616	5	25



Bloc Asignaturas tapa PP 90g 80 hojas

Código	Ref.	Modelo	Rayado	Tmñ	U/Vta	U/Emb
10016113	16494	Surtido	Cuadric. 4x4	F°	8	24
10016114	16495	Surtido	Horizontal	F°	8	24
10016115	16496	Surtido	Cuadric. 4x4	4°	8	48
10016116	16522	Matemáticas	Cuadric. 4x4	F°	4	24
10016117	16523	Idiomas	Cuadric. 4x4	F°	4	24
10016118	16524	Ciencias	Cuadric. 4x4	F°	4	24
10016119	16525	Lenguaje	Cuadric. 4x4	F°	4	24
10016120	16526	Historia	Cuadric. 4x4	F°	4	24
10016121	16527	Geografía	Cuadric. 4x4	F°	4	24
10016122	16528	Física	Cuadric. 4x4	F°	4	24
10016123	16529	Química	Cuadric. 4x4	F°	4	24





90 gr.

Bloc Fluorpac tapa PP 80h cuadrícula 4x4 90g 5 colores surtidos

Código	Ref.	Tamaño	U/Vta	U/Emb
10001669	16551	Fº	5	25
10001670	16552	4º	5	50



90 gr.

Libreta Noventagramos 48 hojas 90g 8 colores surtidos

• A4

Código	Ref.	Rayado	U/Vta	U/Emb
20902090	20287	Cuadric. 3x3	6	36
20901137	20080	Cuadric. 4x4	6	36
20901141	20084	Cuadric. 5x5	6	36
20902091	20288	Cuadric. 6x6	6	36
20902092	20289	Cuadric. 8x8	6	36
20901138	20081	Horizontal	6	36
20901139	20082	Pauta 2,5	6	36
20901140	20083	Pauta 3,5	6	36
20902094	20290	Milimetrado	6	36
20902096	20292	Cuadric. 46	6	36
20902095	20291	Seyes	6	36
20902097	20030	Liso	6	36

• A5+

Código	Ref.	Rayado	U/Vta	U/Emb
20902098	20293	Cuadric. 3x3	6	72
20901142	20090	Cuadric. 4x4	6	72
20902099	20294	Cuadric. 5x5	6	72
20902100	20295	Cuadric. 6x6	6	72
20902101	20296	Cuadric. 8x8	6	72
20901143	20091	Horizontal	6	72
20901144	20092	Pauta 2,5	6	72
20901145	20093	Pauta 3,5	6	72
20902103	20297	Milimetrado	6	72
20902105	20299	Cuadric. 46	6	72
20902106	20031	Liso	6	72

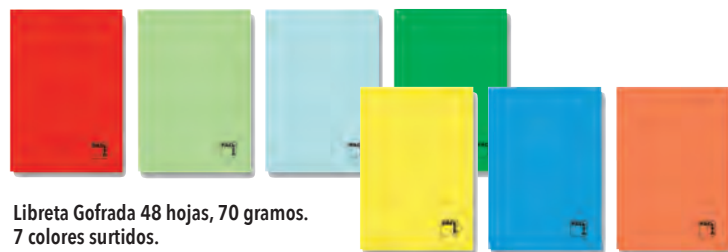

70 gr.

Libreta Gofrada 48 hojas, 70 gramos. 7 colores surtidos.

• A4

Código	Ref.	Rayado	U/Vta	U/Emb
20902107	20330	Cuadric. 3x3	10	40
20902038	20060	Cuadric. 4x4	10	40
20902042	20068	Cuadric. 5x5	10	40
20902108	20331	Cuadric. 6x6	10	40
20902109	20332	Cuadric. 8x8	10	40
20902039	20061	Horizontal	10	40
20902040	20062	Pauta 2,5	10	40
20902041	20063	Pauta 3,5	10	40
20902110	20333	Milimetrado	10	40
20902113	20335	Cuadric. 46	10	40
20902112	20334	Seyes	10	40
20902114	20336	Liso	10	40

• A5+

Código	Ref.	Rayado	U/Vta	U/Emb
20902115	20337	Cuadric. 3x3	10	80
20901016	20070	Cuadric. 4x4	10	80
20902116	20338	Cuadric. 5x5	10	80
20902117	20339	Cuadric. 6x6	10	80
20902118	20340	Cuadric. 8x8	10	80
20902043	20071	Horizontal	10	80
20902044	20072	Pauta 2,5	10	80
20902045	20073	Pauta 3,5	10	80
20902119	20341	Milimetrado	10	80
20902122	20343	Cuadric. 46	10	80
20902123	20344	Liso	10	80



90 gr.

Libreta Noventagramos A4 48 hojas, 90 gramos. Cuadrícula 4x4

Código	Ref.	Color	U/Vta	U/Emb
20902144	20032	Turquesa	6	36
20902145	20033	Rojo	6	36
20902146	20034	Verde	6	36
20902148	20035	Verde oscuro	6	36
20902149	20036	Fucsia	6	36
20902150	20037	Azul	6	36
20902151	20038	Naranja	6	36
20902152	20039	Amarillo	6	36

90 gr.

Libreta A4 gofrada 48 hojas 90 gramos. Cuadrícula 4x4

Código	Ref.	Color	U/Vta	U/Emb
20902153	20345	Verde claro	10	40
20902154	20346	Verde oscuro	10	40
20902155	20347	Azul claro	10	40
20902157	20348	Azul oscuro	10	40
20902158	20349	Amarillo	10	40
20902159	20350	Naranja	10	40
20902160	20351	Rojo	10	40



100 gr.

Bloc Plastipac Lux Fº tapa PP 80h 100g cuadrícula 4x4 10 colores surtidos

Código	Ref.	U/Vta	U/Emb
10002913	16022	5	20



Bloc Plastipac Lux Fº tapa PP 80h 100g cuadrícula 4x4 Expositor de 10

Código	Ref.	U/Vta	U/Emb
10003249	E22/02	1	1



Acabado Soft



Carpebloc Exclusive Soft A4 cartón forrado 4 anillas mixtas recambio 120h, cuadrícula 5x5, 5 separadores (8 col.)

Código	Ref.	Anillas	U/Vta	U/Emb
10403103	25006	25mm	4	12
10403104	25007	35mm	4	12



Recambio XBLOCK A4 80 hojas 90 gramos Cuadrícula 5x5 + Greca

Código	Ref.	Color	U/Vta	U/Emb
25401230	21156	Turquesa	5	25
25401236	21157	Rojo	5	25
25401233	21158	Verde Claro	5	25
25401232	21159	Negro	5	25
25401229	21160	Verde Oscuro	5	25
25401235	21161	Azul Claro	5	25
25401231	21162	Amarillo	5	25
25401234	21163	Naranja	5	25
25401312	21164	Surtido	8	24

90 gr.

Rayado en color azul

Banda del color de la portada



Recambio monocolor A4 100 hojas 90g Cuadrícula 5x5 + Greca

Código	Ref.	Color	U/Vta	U/Emb
25401580	21040	Turquesa	1	20
25401581	21041	Rojo	1	20
25401582	21042	Verde	1	20
25401583	21043	Gris	1	20
25401584	21044	Fucsia	1	20
25401585	21045	Azul	1	20
25401586	21046	Violeta	1	20
25401587	21047	Naranja	1	20
25401588	21048	Surtido	1	24



Recambio A4 90g 4 taladros cuadrícula 5x5, 5 colores de banda

Código	Ref.	Artículo	U/Vta	U/Emb
25401228	21180	120h	1	16
25401676	21190	200h	10	10



Recambio A4 100h 100g 4 taladros cuadrícula 4x4

Código	Ref.	Cantos	U/Vta	U/Emb
25401490	21050	Rectos	1	20
25401634	21051	Romos	20	20



Recambio A4 90g 4 taladros cuadrícula 4x4 con margen

Código	Ref.	Artículo	U/Vta	U/Emb
25401675	21810	120h	1	16
25401674	21283	200h	1	12



Papel A4 80g liso

Código	Ref.	Artículo	U/Vta	U/Emb
12701667	21280	120h	1	16
12701666	21825	200h	1	12



Bloc de dibujo tapa polipropileno F° ProL. Espiral 20h microperforado 2 taladros 140gr

Código	Ref.	Modelo	U/Vta	U/Emb
10003640	18852	Recuadro	10	40
10003641	18853	Liso	10	40

El único bloc de dibujo tapa de PP del mercado



Bloc de dibujo Colours 20 hojas 130g, 230 x 330mm

Código	Ref.	Artículo	U/Vta	U/Emb
10002423	18836	Con recuadro	10	40
10002424	18837	Sin recuadro	10	40



Bloc de dibujo Art F° ProL. Espiral 20h microperforado 2 taladros 140g

Código	Ref.	Modelo	U/Vta	U/Emb
10003580	18848	Recuadro	10	40
10003023	18849	Liso	10	40



Bloc de dibujo Art A3+ Espiral 20h Liso 140g

Código	Ref.	U/Vta	U/Emb
10003642	18843	5	20



Bloc de Música 20h

Código	Ref.	Pentagramas	Modelo	Tamaño	U/Vta	U/Emb
10009005	18804	4	Ancho Apdo.	4º	20	60
10009006	18803	6	Medio Apdo.	4º	20	60
10009007	18801/MU8	8	Estr. Apdo.	4º	20	60
10009008	18805	16	Estr. Apdo.	Fº	10	40



Carpeta de anillas Bee Blue A4 polipropileno

Código	Ref.	Color	Artículo	U/Vta	U/Emb
10404203	54110E	Surtido	2 anillas 15mm	20	20
10404208	51110E	Surtido	4 anillas 15mm	20	20
10404226	54140E	Surtido	2 anillas 30mm	12	12
10404229	51140E	Surtido	4 anillas 30mm	12	12
10404227	54142E	Azul marino	2 anillas 30mm	12	12
10404232	51142E	Azul marino	4 anillas 30mm	12	12



Carpeta de gomas y solapas Bee Blue A4 polipropileno

Código	Ref.	Color	U/Vta	U/Emb
10404234	55110E	Surtido	24	24
10404235	55112E	Azul marino	24	24



Carpeta de proyectos Bee Blue A4 4cm polipropileno cierre con gomas

Código	Ref.	Color	U/Vta	U/Emb
10404236	59140E	Surtido	1	8
10404237	59142E	Azul marino	1	8



Carpeta de fundas Bee Blue A4 polipropileno semi rígido

Código	Ref.	Color	Artículo	U/Vta	U/Emb
15302961	88110E	Surtido	20 fundas	20	20
15302962	88120E	Surtido	30 fundas	12	12
15302964	88130E	Surtido	40 fundas	12	12
15302963	88182E	Azul marino	30 fundas	12	12



Portatodo Bee Blue cuadrado Convertible en portalápices 2 colores surtidos

Código	Ref.	U/Vta	U/Emb
11302111	52790E	6	6



Carpeta de anillas Aquarel A4 cartón forrado anillas mixtas de 25mm

Código	Ref.	Color	Artículo	U/Vta	U/Emb
10403745	54563E	Verde pastel	2 anillas	1	10
10403746	54565E	Malva	2 anillas	1	10
10403747	54566E	Rosa	2 anillas	1	10
10403748	54567E	Coral	2 anillas	1	10
10403749	54568E	Azul pastel	2 anillas	1	10
10403750	54569E	Amarillo limón	2 anillas	1	10
10403544	54560E	5 col. surtidos	2 anillas	1	10
10403751	51563E	Verde pastel	4 anillas	1	10
10403752	51565E	Malva	4 anillas	1	10
10403753	51566E	Rosa	4 anillas	1	10
10403754	51567E	Coral	4 anillas	1	10
10403755	51572E	Azul pastel	4 anillas	1	10
10403756	51569E	Amarillo limón	4 anillas	1	10
10403543	51560E	5 col. surtidos	4 anillas	1	10



Carpeta de fundas Aquarel A4 PP semi rígido 5 colores surtidos

Código	Ref.	Artículo	U/Vta	U/Emb
15302803	88260E	20 fundas	1	20
15302705	88360E	30 fundas	1	12
15302706	88460E	40 fundas	1	12
15302804	88560E	50 fundas	1	12
15302707	88660E	60 fundas	1	8



Carpeta de gomas y solapas Aquarel A4 cartón 400g

Código	Ref.	Color	U/Vta	U/Emb
10403539	55528E	Azul pastel	1	25
10403538	55527E	Coral	1	25
10403541	55535E	Malva	1	25
10403540	55533E	Verde pastel	1	25
10403759	55529E	Amarillo limón	1	25
10403537	55560E	5 col. surtidos	1	50



Portatodo Aquarel PU

Código	Ref.	Artículo	U/Vta	U/Emb
11301949	52570E	Redondo	6	6
11301950	52580E	Cuadrado	6	6
11301924	52560E	Surtido	1	18



Archivador de palanca Aquarel A4 cartón forrado. Lomo redondo 80mm, con ollado y cierre con goma.

Código	Ref.	Color	U/Vta	U/Emb
11602070	53766E	Azul pastel	1	6
11602069	53764E	Coral	1	6
11602072	53768E	Malva	1	6
11602071	53767E	Verde pastel	1	6
11602073	53779E	Amarillo limón	1	6
11601988	53760E	5 col. surtidos	1	1



Bloc Mimesys F° 80h 90g cuadricula 4x4

Código	Ref.	Color	Tapa	U/Vta	U/Emb
10003257	696953C	Vivos	Cartón	20	20
10003258	696983C	Pastel	Cartón	20	20
10003261	596953C	Vivos	Polipropileno	20	20
10003262	596983C	Pastel	Polipropileno	20	20

Bloc Mimesys F° 80h 90g cuadricula 4x4 Pack de 5

Código	Ref.	Color	Tapa	U/Vta	U/Emb
10003259	696053C	Vivos	Cartón	4	4
10003260	696083C	Pastel	Cartón	4	4
10003263	596053C	Vivos	Polipropileno	4	4
10003264	596083C	Pastel	Polipropileno	4	4



Tapa polipropileno



Tapa extradura

Bloc Mimesys A4+ 120h 90g microperforado cuadricula 5x5 Colores surtidos

Código	Ref.	Tapa	U/Vta	U/Emb
10003267	598753C	Polipropileno	15	15
10003268	198753C	Extradura	15	15



Libreta Mimesys A4 48h tapa polipropileno *Con margen

Código	Ref.	Tamaño	U/Vta	U/Emb
20902034	303162C	Cuadrícula 5x5	10	40
20902036	303164C	Cuadrícula 4x4*	10	40
20902035	303165C	Horizontal*	10	40



Bloc Mimesys A4+ 80h 90g microperforado cuadricula 5x5 tapa de cartón Colores vivos

10003266 - Pack de 4

Código	Ref.	U/Vta	U/Emb
10003265	696803C	24	24
10003266	696003C	6	6



Libreta Mimesys 48h cuadricula 5x5 tapa polipropileno

Código	Ref.	Tamaño	U/Vta	U/Emb
20902169	303592C	9x14cm	10	60
20902170	303602C	11x17cm	10	60
20902171	303682C	A5	10	60



Libreta 48h tapa polipropileno Colores pastel surtidos

Código	Ref.	Tamaño	Rayado	U/Vta	U/Emb
20902179	308162C	A4	Cuadrícula 5x5	10	40
20902177	308682C	A5	Cuadrícula 5x5	10	60
20902180	308166C	A4	Horizontal	10	40
20902178	308686C	A5	Horizontal	10	60



Carpeta de fundas (tarifario) F° Studio Style PP con espiral

• 20 fundas

Código	Ref.	Color	U/Vta	U/Emb
15302409	842002	Rosa	1	20
15302410	842003	Azul	1	20
15302411	842004	Verde	1	20
15302412	842009	Naranja	1	20
15302799	842001	Negro	1	20

• 30 fundas

Código	Ref.	Color	U/Vta	U/Emb
15302413	843002	Rosa	1	20
15302414	843003	Azul	1	20
15302415	843004	Verde	1	20
15302416	843009	Naranja	1	20
15302800	843001	Negro	1	20

• 40 fundas

Código	Ref.	Color	U/Vta	U/Emb
15302417	844002	Rosa	1	10
15302418	844003	Azul	1	10
15302419	844004	Verde	1	10
15302420	844009	Naranja	1	10
15302801	844001	Negro	1	10

• 50 fundas

Código	Ref.	Color	U/Vta	U/Emb
15302421	845002	Rosa	1	10
15302422	845003	Azul	1	10
15302423	845004	Verde	1	10
15302424	845009	Naranja	1	10
15302802	845001	Negro	1	10



Clasificador lomo fuele Studio Style PP F° 12 separadores y gomas

Código	Ref.	Color	U/Vta	U/Emb
10301655	888002	Rojo	1	1
10301656	888003	Azul	1	1
10301657	888004	Verde	1	1
10301658	888009	Naranja	1	1
10301659	888018	Expositor de 8	1	1

Carpeta de gomas y solapas PP F°

Código	Ref.	Color	U/Vta	U/Emb
10401652	825500	Transparente	10	96
10401653	825502	Rojo	10	96
10401654	825503	Azul	10	96
10401655	825504	Verde	10	96
10401656	825509	Naranja	10	96
10401657	825518	Exp. de 50	1	1

Carpeta forrada de anillas Studio Style F° 4 anillas

• Anillas de 25mm

Código	Ref.	Color	U/Vta	U/Emb
10401667	921402	Rojo	12	24
10401668	921403	Azul	12	24
10401669	921404	Verde	12	24
10401670	921408	Amarillo	12	24
10401646	921418	Expositor de 12	1	1

• Anillas de 40mm

Código	Ref.	Color	U/Vta	U/Emb
10401663	921802	Rojo	1	16
10401664	921803	Azul	1	16
10401665	921804	Verde	1	16
10401666	921808	Amarillo	1	16
10401647	921818	Expositor de 8	1	1

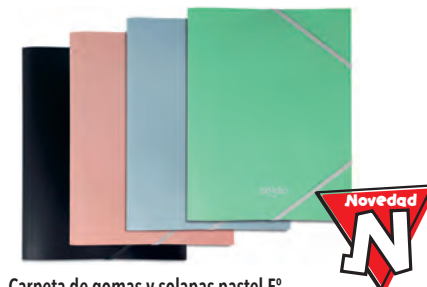

Carpebloc Minimal 320x280mm cartón forrado 4 anillas mixtas de 35mm recambio 100h 90g cuadrícula

Código	Ref.	Color	U/Vta	U/Emb
10404068	823701	Negro	1	8
10404090	823702	Rosa	1	8
10404092	823703	Azul	1	8
10404093	823704	Verde	1	8
10404108	823718	Expositor de 8	1	1

Carpeta de gomas y solapas pastel F° polipropileno opaco

Código	Ref.	Color	U/Vta	U/Emb
10404109	825401	Negro	10	50
10404111	825402	Rosa	10	50
10404116	825403	Azul	10	50
10404130	825404	Verde	10	50
10404139	825418	Expositor de 50	1	1



Carpeta de anillas Pastel Touch F° 4 anillas mixtas

• Anillas de 25mm

Código	Ref.	Color	U/Vta	U/Emb
10404141	921301	Negro	1	24
10404151	921302	Rosa	1	24
10404158	921303	Azul	1	24
10404159	921304	Verde	1	24
10404161	921318	Expositor de 12	1	1

• Anillas de 40mm

Código	Ref.	Color	U/Vta	U/Emb
10404168	921901	Negro	1	16
10404180	921902	Rosa	1	16
10404182	921903	Azul	1	16
10404198	921904	Verde	1	16
10404199	921918	Expositor de 8	1	1



Botella termo Zoo 350ml acero inoxidable Expositor de 12

Código	Ref.	Ud/Vta	Ud/Emb
28101094	75843511	1	1



Cuaderno A5 Competencia lectora

Código	Ref.	Artículo	U/Vta	U/Emb
12602175	CL1	Nº1	5	250
12602176	CL2	Nº2	5	250
12602177	CL3	Nº3	5	250
12602178	CL4	Nº4	5	250
12602179	CL5	Nº5	5	250



Cuaderno A4 Competencia matemática

Código	Ref.	Artículo	U/Vta	U/Emb
12601073	CM1	Nº1	5	250
12601074	CM2	Nº2	5	250
12601075	CM3	Nº3	5	250
12601076	CM4	Nº4	5	250
12601077	CM5	Nº5	5	250
12601078	CM6	Nº6	5	250



Cuaderno A4 in English

Código	Ref.	Artículo	U/Vta	U/Emb
22201015	RE6B	Beginners 6	5	200
22201016	RE6A	Advanced 6	5	200
22201017	RE7B	Beginners 7	5	200
22201018	RE7A	Advanced 7	5	200
22201019	RE8B	Beginners 8	5	200
22201020	RE8A	Advanced 8	5	200
22201033	RE9B	Beginners 9	5	200
22201034	RE9A	Advanced 9	5	200
22201035	RE10B	Beginners 10	5	200
22201036	RE10A	Advanced 10	5	200
22201037	RE11B	Beginners 11	5	200
22201038	RE11A	Advanced 11	5	200



Cuaderno A4 Mi cuaderno de verano

Código	Ref.	Artículo	U/Vta	U/Emb
22201179	VERANO34	3-4 años	5	250
22201180	VERANO45	4-5 años	5	250
22201181	VERANO56	5-6 años	5	250
22201182	VERANO67	6-7 años	5	250
22201183	VERANO78	7-8 años	5	250
22201184	VERANO89	8-9 años	5	250



Cuaderno Vacaciones
100% de devolución

Cuaderno A4 Vacaciones

Código	Ref.	Artículo	U/Vta	U/Emb
22201007	VAC3I	3º Educación Infantil	5	100
22201008	VAC1P	1º Primaria	5	100
22201010	VAC2P	2º Primaria	5	100
22201011	VAC3P	3º Primaria	5	100
22201012	VAC4P	4º Primaria	5	100
22201013	VAC5P	5º Primaria	5	100



Cuaderno A5 Lecturas comprensivas

Código	Ref.	Artículo	U/Vta	U/Emb
22201039	LC4	+ 4 años	5	250
22201040	LC5	+ 5 años	5	250
22201041	LC6	+ 6 años	5	250
22201042	LC7	+ 7 años	5	250



Cuaderno Ortografía

Código	Ref.	Artículo	U/Vta	U/Emb
22201101	ORT1	1	5	50
22201102	ORT2	2	5	50
22201103	ORT3	3	5	50
22201104	ORT4	4	5	50
22201105	ORT5	5	5	50
22201106	ORT6	6	5	50



Cuaderno A5 Educación Infantil

Código	Ref.	Artículo	U/Vta	U/Emb
22201074	EI1	Nº1 Animales del bosque	10	500
22201075	EI2	Nº2 Medios transporte	10	500
22201076	EI3	Nº3 El espacio	10	500
22201077	EI4	Nº4 El mar	10	500
22201078	EI5	Nº5 El circo	10	500
22201079	EI6	Nº6 Los indios	10	500
22201080	EI7	Nº7 Las estaciones	10	500
22201081	EI8	Nº8 El colegio	10	500
22201082	EI9	Nº9 Instrumentos musicales	10	500
22201083	EI10	Nº10 Piratas	10	500



Cuaderno Estimulación Cognitiva Atención

Código	Ref.	Artículo	U/Vta	U/Emb
12602104	ECA1	Atención 1	5	5
12602105	ECA2	Atención 2	5	5
12602106	ECA3	Atención 3	5	5



Cuaderno Estimulación Cognitiva Cálculo

Código	Ref.	Artículo	U/Vta	U/Emb
12602107	ECC1	Cálculo 1	5	5
12602120	ECC2	Cálculo 2	5	5
12602121	ECC3	Cálculo 3	5	5



Cuaderno Estimulación Cognitiva Gnosias

Código	Ref.	Artículo	U/Vta	U/Emb
12602110	ECG1	Gnosias 1	5	5
12602111	ECG2	Gnosias 2	5	5
12602112	ECG3	Gnosias 3	5	5



Cuaderno Estimulación Cognitiva Lectura

Código	Ref.	Artículo	U/Vta	U/Emb
12602116	ECLE1	Lectura 1	5	5
12602117	ECLE2	Lectura 2	5	5
12602118	ECLE3	Lectura 3	5	5



Cuaderno Estimulación Cognitiva Memoria

Código	Ref.	Artículo	U/Vta	U/Emb
12602119	ECM1	Memoria 1	5	5
12602108	ECM2	Memoria 2	5	5
12602109	ECM3	Memoria 3	5	5



Cuaderno Estimulación Cognitiva Lenguaje

Código	Ref.	Artículo	U/Vta	U/Emb
12602113	ECL1	Lenguaje 1	5	5
12602114	ECL2	Lenguaje 2	5	5
12602115	ECL3	Lenguaje 3	5	5



Cuaderno Estimulación Cognitiva Praxias

Código	Ref.	Artículo	U/Vta	U/Emb
12602122	ECP1	Praxias 1	5	5
12602123	ECP2	Praxias 2	5	5
12602124	ECP3	Praxias 3	5	5



Cuaderno A5 Escritura

Código	Ref.	Artículo	U/Vta	U/Emb
12602013	C0	Nº 0	10	10
12602014	C01	Nº 01	10	10
12602015	C02	Nº 02	10	10
12602016	C03	Nº 03	10	10
12602017	C04	Nº 04	10	10
12602018	C05	Nº 05	10	10
12602019	C06	Nº 06	10	10
12602020	C07	Nº 07	10	10
12602021	C08	Nº 08	10	10
12602022	C09	Nº 09	10	10
12602023	C010	Nº 010	10	10

Código	Ref.	Artículo	U/Vta	U/Emb
12602024	C1	Nº 1	10	10
12602025	C2	Nº 2	10	10
12602026	C3	Nº 3	10	10
12602027	C4	Nº 4	10	10
12602028	C5	Nº 5	10	10
12602029	C6	Nº 6	10	10
12602030	C7	Nº 7	10	10
12602031	C8	Nº 8	10	10
12602032	C9	Nº 9	10	10
12602033	C10	Nº 10	10	10
12602034	C11	Nº 11	10	10
12602035	C12	Nº 12	10	10
12602036	C13	Nº 13	10	10

Cuaderno A5 Operaciones y Problemas

Código	Ref.	Artículo	U/Vta	U/Emb
12602043	P1	Nº 1	10	10
12602044	P2	Nº 2	10	10
12602045	P3	Nº 3	10	10
12602046	P4	Nº 4	10	10
12602047	P5	Nº 5	10	10
12602048	P6	Nº 6	10	10
12602049	P7	Nº 7	10	10
12602050	P8	Nº 8	10	10
12602051	P9	Nº 9	10	10
12602052	P10	Nº 10	10	10
12602053	P11	Nº 11	10	10
12602054	P12	Nº 12	10	10
12602055	P13	Nº 13	10	10
12602056	P14	Nº 14	10	10
12602057	P15	Nº 15	10	10
12602058	P16	Nº 16	10	10
12602059	P17	Nº 17	10	10
12602060	P18	Nº 18	10	10
12602061	P19	Nº 19	10	10
12602037	P1A	Nº 1/A	10	10
12602038	P2A	Nº 2/A	10	10
12602039	P3A	Nº 3/A	10	10
12602040	P4A	Nº 4/A	10	10
12602041	P5A	Nº 5/A	10	10
12602042	P6A	Nº 6/A	10	10





Cuaderno Habilidades matemáticas

Código	Ref.	Artículo	U/Vta	U/Emb
22201204	HM3	+ 3 años	1	50
22201205	HM4	+ 4 años	1	50
22201206	HM5	+ 5 años	1	50

Cuaderno A4 Mayúsculas

Código	Ref.	Artículo	U/Vta	U/Emb
12602143	MY1	1	10	10
22201098	MAY2A	2A	10	200
22201099	MAY2B	2B	10	200
22201100	MAY_3	3	10	200

Cuaderno A4

Código	Ref.	Artículo	U/Vta	U/Emb
22201147	Mc_escibir	Escribir y leer mejor	5	50
22201148	Mc_comprender	Comprender mejor lo que lees	5	50
22201149	Mc_memoria	Concentrarte y memorizar mejor	5	50
22201150	Mc_logica	Razonar con lógica y calcular mejor	5	50
22201151	Mc_emociones	Comprender mejor tus emociones	5	50



420 x Escritura
500 x Op. y problemas
200 x Educación Infantil
25 x Competencia Lectora
10 x Iniciación a la lectura
10 x Lecturas Comprensivas
30 x Ortografía
30 x Competencia Matemática
25 x Rubio English
20 x Mayúsculas
15 x Habilidades Matemáticas

420 x Escritura
500 x Op. y problemas
200 x Educación Infantil
25 x Competencia Lectora
10 x Iniciación a la lectura
5 x Lecturas Comprensivas
30 x Ortografía
30 x Competencia Matemática
30 x Rubio English
10 x Mayúsculas

Cuadernos surtidos Expositor Giratorio de 1260

Código	U/Vta	U/Emb
18901024	1	1



Cuadernos surtidos Expositor de pared de 1285

Código	U/Vta	U/Emb
18901197	1	1



30x Educación Infantil 1, 5, 8
20x Iniciación a la lectura 4,5
10x Lecturas comprensivas 6
50x Competencia Lectora 1,2,3,4,5
50x Escritura 02, 06, 3, 6, 10
110x Operaciones y Problemas (1A, 2A, 3A, 4A, 5A, 8, 10, 12, 14, 16, 18)
10x Mayúsculas 2A, 2B
60x Ortografía 1,2,3,4,5,6
60x Competencia Matemática 1,2,3,4,5,6

Cuadernos surtidos Expositor surtido de 400

Código	Ref.	U/Vta	U/Emb
22201199	EXP_FRONTAL PEQ	1	1



12x Ortografía
12x Comp. matemática
12x Inglés
8x Mayúsculas
4x Colorear
5x Mejora tus competencias

Cuaderno A4 Expositor surtido de 53

Código	Ref.	U/Vta	U/Emb
12602144	138575	1	1



5x Iniciación a la Lectura +4
5x Iniciación a la lectura + 5
5x Lecturas comprensivas +6
5x Lecturas comprensivas +7
5x Competencia Lectora 1
5x Competencia Lectora 2
5x Competencia Lectora 3
5x Competencia Lectora 4
5x Competencia Lectora 5

Cuaderno A5 Mini colecciones lecturas Expositor surtido de 45

Código	Ref.	U/Vta	U/Emb
22201198	EXPA5 - MINI	1	1

GAMA SUNSET

SUNSET SERIES



Goma Nata 320 Sunset
Caja surtida de 20

Código	Ref.	U/Vta	U/Emb
11101328	CPM320SN	1	25



Afilaborra Capsule Sunset
Expositor surtido de 16

Código	Ref.	U/Vta	U/Emb
13701198	4721116	1	8



Afilalápiz Compact Sunset
Expositor surtido de 24

Código	Ref.	U/Vta	U/Emb
13701215	20166224SN	1	12



Bolígrafo retráctil Compact Sunset (tinta azul)
Expositor de 20 (4 colores surtidos)

Código	Ref.	U/Vta	U/Emb
10101355	176568920SN	1	18



Portaminas Compact Sunset 2B 0,7mm
Expositor 20 surtido (4 colores surtidos)

Código	Ref.	U/Vta	U/Emb
10101356	18502920SN	1	18



Lápiz de grafito HB Sunset con goma
Caja de 24 surtidos

Código	Ref.	U/Vta	U/Emb
12802412	071622724	1	6



Lápiz de colores Sunset mina gruesa
Estuche de 6

Código	Ref.	U/Vta	U/Emb
12802258	071522206	1	6



Lápices de colores Maxi multicolor Sunset
Estuche de 12

Código	Ref.	U/Vta	U/Emb
12802548	0717251512SN	1	6



Barra de pegamento Sunset 8g
Expositor de 24

Código	Ref.	U/Vta	U/Emb
23101375	4410924SN	1	16



Tijeras escolares Sunset 13cm
en blíster

Código	Ref.	Color	U/Vta	U/Emb
27601213	BWM10444Y	Amarillo	6	12
27601214	BWM10444T	Turquesa	6	12



Calculadora de bolsillo Sunset, 8 dígitos

Código	Ref.	Descripción	U/Vta	U/Emb
15401597	159512SN	Expositor surtido de 12	1	4
15401593	151008SNPRL	Blíster 1 - Lila/Rosa	1	15
15401594	151008SNYBL	Blíster 1 -Turquesa/Amarillo	1	15



Calculadora sobremesa Sunset 12 dígitos

Código	Ref.	Descripción	U/Vta	U/Emb
15401616	159706SN	Expositor surtido de 6	1	4
15401617	151812SNPBL	Blíster 1 - Amarillo/rosa	1	5
15401618	151812SNPRL	Blíster 1 -Lila/turquesa	1	5



Calculadora científica Sunset
10+2 dígitos M240

Código	Ref.	Color	U/Vta	U/Emb
15401583	159110SNPBL	Rosa	1	10
15401584	159110SNGRBL	Verde	1	10



Portaminas Capsule Fluo 1,3 mm 2B
Expositor surtido de 20

Código	Ref.	U/Vta	U/Emb
24302413	18504920	1	18



Regla triangular Acid 15cms
Expositor surtido de 60

Código	Ref.	U/Vta	U/Emb
25501093	351260C	1	21

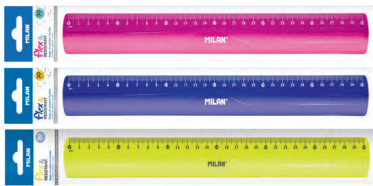

Regla 30 cms Flex&Resistant (semiflexible)

Código	Ref.	Color	U/Vta	U/Emb
25501065	353801	Azul	1	24
25501077	353801P	Rosa	1	24
25501094	353801Y	Amarillo	1	24



Portagomas automático triangular Tri Jet
Expositor de 21 (3 colores surtidos)

Código	Ref.	U/Vta	U/Emb
11101289	3026521	1	6

- Recambio goma triangular automático Tri Jet
Bolsa de 5

Código	Ref.	U/Vta	U/Emb
11101290	30260505	15	225



Equipo dibujo Flex&Resistant (semiflexible)

Código	Ref.	Color	U/Vta	U/Emb
18401022	359801	Azul	1	24
18401027	359801P	Rosa	1	24
18401029	359801Y	Amarillo	1	24

Regla 30cm
Escuadra 90°/45°/45°
Cartabón 90°/60°/30°
Transportador 180° 10cm



Corrector cinta Acid con pulsador 5mm x 6m
Expositor surtido de 12

Código	Ref.	U/Vta	U/Emb
15101092	1304912	1	25



Corrector Pocket cinta 4,2mm x 5m
Expositor surtido de 12

Código	Ref.	U/Vta	U/Emb
15101106	1302912	1	12



Notas adhesivas translúcidas 50h
76x76mm

Código	Ref.	Color	U/Vta	U/Emb
26901382	411260850	Rosa	18	216
26901381	411261050	Amarillo	18	216
26901454	411260050	Transparente	18	216



Afilaborra Tri
Expositor surtido de 16

Código	Ref.	U/Vta	U/Emb
11101209	4700116	1	10



Afilalápiz Double 1 uso con depósito
Expositor surtido de 18

Código	Ref.	U/Vta	U/Emb
13702008	20152918	1	10



Roller pegamento adhesivo
8,4mm x 12m
Expositor surtido de 12

Código	Ref.	U/Vta	U/Emb
23108001	44GT12	1	12



Cutter Capsule Acid cerámica

Código	Ref.	Color	U/Vta	U/Emb
17201103	BWM10337B	Azul	1	12
17201104	BWM10337Y	Amarillo	1	12

- Recambio cutter Capsule

Código	Ref.	U/Vta	U/Emb
25401437	BWM10338	12	96



Tijeras Acid 17cm

Código	Ref.	Artículo	U/Vta	U/Emb
27601180	BWM10425Y	Amarillo	6	12
27601182	BWM10425P	Rosa	6	12
27601181	BWM10425B	Azul	6	12



Sacapuntas eléctrico Power Sharp
Con depósito

Código	Ref.	Color	U/Vta	U/Emb
13701193	BWM10375	Amarillo	1	12
13701194	BWM10149	Azul	1	12

Incluye 4 pilas AA

**GAMA
NEW LOOK**

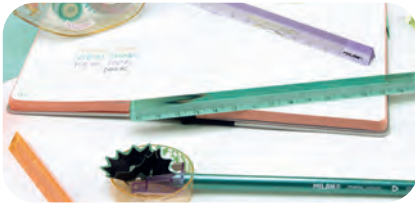

Regla triangular New Look 15cms
Expositor surtido de 60

Código	Ref.	U/Vta	U/Emb
25501130	351260LK2	1	21



Regla New Look verde

Código	Ref.	Artículo	U/Vta	U/Emb
25501140	357801NL	20cm	1	24
25501141	353801NL	30cm	1	24



Equipo dibujo New Look 30cm
trazado transparente

Código	Ref.	U/Vta	U/Emb
18401064	359801NL	1	24



Afilapiz Spin 1 uso con depósito
Expositor surtido de 24

Código	Ref.	U/Vta	U/Emb
13702007	20157924LK2	1	9



Afilaborra Capsule New Look
Expositor surtido de 16

Código	Ref.	U/Vta	U/Emb
13701290	4701116LK2	1	10



**GAMA
1918**

**1918
SERIES**



Sacapuntas Serie 1918 1 uso
Expositor surtido de 32

Código	Ref.	U/Vta	U/Emb
13701801	20140932	1	5



Afilaborra Compact 1918
Expositor surtido de 16

Código	Ref.	U/Vta	U/Emb
13701291	4703116SNC	1	10



Cutter Stick 1918 cerámica

Código	Ref.	Color	U/Vta	U/Emb
17201101	BWM10348B	Azul	1	12
17201102	BWM10348P	Rosa	1	12



Corrector cinta mini
5 mm x 6 m
Colores surtidos

Código	Ref.	U/Vta	U/Emb
15103280	1301940SNC	40	240

**Apto para
zurdos**



**Incluye
4 pilas AA**

Sacapuntas eléctrico Power Sharp
Doble con depósito y tapa de seguridad.

Código	Ref.	U/Vta	U/Emb
13701033	BWM10278	1	12



Goma miga de pan 403 Gigante

Código	Ref.	U/Vta	U/Emb
11101036	CMM403	3	75



Goma miga de pan 420 colores surtidos

Código	Ref.	U/Vta	U/Emb
11101039	CMM420	20	500



Goma miga de pan 430 cuadrada colores surtidos

Código	Ref.	U/Vta	U/Emb
11101040	CMM430	30	750



Goma 445 miga de pan flexible escolar, colores surtidos

Código	Ref.	U/Vta	U/Emb
11101041	CMM445	45	1125



Goma miga de pan 428 triangular Caja de 28

Código	Ref.	U/Vta	U/Emb
11101180	CMM428	1	8



Goma miga de pan 1012 ovalada (lengua de gato) Recambio para afilaborra Capsule.

Código	Ref.	U/Vta	U/Emb
11101235	CMM1012	12	300



Goma miga de pan 412 Professional Soft

Código	Ref.	U/Vta	U/Emb
11101343	CMM412CF	12	25



Goma 1420 Master Gum Especial Bellas Artes Caja de 5

Código	Ref.	U/Vta	U/Emb
11101006	CMM1420-05	1	25



Goma nata de plástico suave 612 biselada

Código	Ref.	U/Vta	U/Emb
11101045	CPM612	12	300



Goma nata de plástico suave 624 con celofán protector

Código	Ref.	U/Vta	U/Emb
11101046	CPM624	24	600



Goma 8020 suave (caucho sintético) con dos intensidades de borrado: Suave (lado rosa), abrasivo (lado azul)

Código	Ref.	U/Vta	U/Emb
11101049	CCM8020	20	500



Corrector líquido bolígrafo 7ml Expositor de 24

Código	Ref.	U/Vta	U/Emb
15101107	1307924	1	9



Barra de pegamento

Código	Ref.	Artículo	U/Vta	U/Emb
23101168	4410924	8g	1	24
23101169	4415912	21g	1	12
23101170	4420912	40g	1	12



Barra de pegamento color 21g

Código	Ref.	Artículo	U/Vta	U/Emb
23101365	4415912YT	Azul	1	12
23101366	4415912PCK	Violeta	12	12



Apto para zurdos

Corrector cinta punta giratoria 5mm x 8m Expositor de 12

Código	Ref.	U/Vta	U/Emb
15103274	80185	1	20



Sacapuntas Collection School doble con depósito Expositor surtido 12

Código	Ref.	U/Vta	U/Emb
13701786	20161912	1	5



Sacapuntas Sphere doble con depósito Expositor surtido de 24

Código	Ref.	U/Vta	U/Emb
13701255	20156824FL	1	6

Borrador pizarra magnético + 4 rotuladores

Código	Ref.	U/Vta	U/Emb
11101025	165894	1	12





Bolígrafo retráctil P1 Touch 1mm

Código	Ref.	Color	U/Vta	U/Emb
10102975	176510925	Azul	25	1200
10103102	176511925	Negro	25	1200
10103101	176512925	Rojo	25	1200
10102990	176513925	Verde	25	1200



Bolígrafo retráctil P1 Camaleon Expositor surtido de 20

Código	Ref.	U/Vta	U/Emb
10101275	1765729120	1	18



Portaminas PL1 HB 0,7mm Expositor surtido de 20

Código	Ref.	U/Vta	U/Emb
24302416	185011920	1	18



Roller Dry-Gel retráctil 0,7 mm

Código	Ref.	Color	U/Vta	U/Emb
10101670	176540125	Azul	25	1200
10101671	176541125	Negro	25	1200
10101672	176542125	Rojo	25	1200



Portaminas PL1 Touch 0,9mm Expositor surtido de 20

Código	Ref.	U/Vta	U/Emb
24302432	185012920	1	18



Portaminas PL1 HB 0,5mm Expositor surtido de 20

Código	Ref.	U/Vta	U/Emb
24302412	185010920	1	18



Portaminas 5,2mm Caja de 6

Código	Ref.	U/Vta	U/Emb
12501008	535206	1	50

• Minus 5,2mm Caja de 6

Código	Ref.	U/Vta	U/Emb
21901172	3802062	1	36



Afilaborra Compact Extension Swims Expositor surtido de 16

Código	Ref.	U/Vta	U/Emb
13701256	4725116SM	1	10



Afilaborra Compact Extension Ninjutsu Expositor surtido de 16

Código	Ref.	U/Vta	U/Emb
13701275	4725116NJ	1	10



Afilaborra Capsule Expositor surtido de 16

Código	Ref.	U/Vta	U/Emb
11101195	4701116	1	10



Afilaborra Capsule Silver Expositor surtido de 12

Código	Ref.	U/Vta	U/Emb
13701020	4714112	1	12



Afilaborra Capsule Copper Expositor surtido de 12

Código	Ref.	U/Vta	U/Emb
13701168	4717112	1	12



Afilaborra Compact Mix Expositor surtido de 24

Código	Ref.	U/Vta	U/Emb
13701240	4710624	1	6



Afilaborra Compact Touch Caja surtido de 16

Código	Ref.	U/Vta	U/Emb
11101221	4706116	1	8



Afilaborra Capsule Fairy Tale Expositor surtido de 16

Código	Ref.	U/Vta	U/Emb
13701274	4701116FR	1	10



Afilaborra Compact Touch The Yeti Expositor surtido de 16

Código	Ref.	U/Vta	U/Emb
13701289	4703116YT	1	10

MILAN®



Calculadora de bolsillo Pocket, 8 dígitos
Expositor de 12 (colores surtidos)

Código	Ref.	U/Vta	U/Emb
15402020	159912	1	4



Calculadora de sobremesa extra grande
12 dígitos (teclas grandes)

Código	Ref.	U/Vta	U/Emb
15401422	150912KBL	1	10



Calculadora sobremesa Duo 10 dígitos
Expositor de 6 (colores surtidos)

Código	Ref.	U/Vta	U/Emb
15401421	159906	1	4



Calculadora sobremesa Silver, 10 dígitos
Expositor de 6 (colores surtidos)

Código	Ref.	U/Vta	U/Emb
15401389	159906SL	1	4



Efecto antibacteriano
Calculadora sobremesa turquesa 12 dígitos
Blíster de 1

Código	Ref.	U/Vta	U/Emb
15401609	151812IBGGRBL	1	5



Efecto antibacteriano
Calculadora científica Antibacteriana
10+2 dígitos 2 líneas

Código	Ref.	Color	U/Vta	U/Emb
15401599	159110IBGGRBL	Turquesa	1	10
15401600	159110IBGPBL	Rosa	1	10



Calculadora científica 10+2 dígitos 240 funciones.
Pantalla de 2 líneas

Código	Ref.	Color	U/Vta	U/Emb
15401534	159110WBL	Blanco	1	10
15404003	159110KBL	Negro	1	10
15404002	159110RBL	Negro/rojo	1	10
15404004	159110GRBL	Verde	1	10
15401535	159110SLBL	Silver	1	10
15401536	159110CPBL	Cooper	1	10



Moldeadores 2 mangos + 8 puntas
Bolsa de 10

Código	Ref.	U/Vta	U/Emb
24101440	9194110	12	72



Pasta de modelar Soft Dough
Ingredientes origen vegetal,
suave y fácil de moldear.

Código	Ref.	Color	Caja	U/Vta	U/Emb
25201672	913510B	Básicos	10uds x 85g	2	6
25201670	913505N	Neón	5uds x 142g	2	6
25201671	913505G	Glitter	5uds x 142g	2	6



Pasta modelar
Maletín de Soft Dough con herramientas

Código	Ref.	Maletín	Artículo	U/Vta	U/Emb
25201757	913304HF	4 uds - 116g	Caras divertidas	2	6
25201808	913304HB	4 uds - 116g	Hamburguesas	2	6
25201759	913306ICW	6 uds - 59g	Helados y gofres	2	6
25201758	913308CT	8 uds - 59g	Hora de cocinar	2	6
25201807	913308LL	8 uds - 59g	Muchas letras	2	6



Marcador textil
Estuche de 6

Código	Ref.	U/Vta	U/Emb
10207130	06P6T	6	12

MILAN®



Lápices de colores triangulares Ergo Grip mina de 2,9mm

Código	Ref.	Estuche	U/Vta	U/Emb
12801498	0722312	12 uds	1	96
12801944	0722318	18 uds	1	96
12801499	0722324	24 uds	1	96



Lápices de colores Maxi triangular mina de 5mm Estuche de 12

Código	Ref.	U/Vta	U/Emb
12802044	0722612	1	12



Rotulador 631 punta cónica Tinta base de agua

Código	Ref.	Estuche	U/Vta	U/Emb
10201969	0612312	12 uds	1	144
10203431	80092	18 uds	6	72
10203527	0612324	24 uds	6	49
10201835	0615350	50 uds	12	12



Rotulador 641 punta MAXI. Tinta base agua Estuche de 12 colores

Código	Ref.	U/Vta	U/Emb
10201561	80020	1	72



Rotuladores punta pincel

Código	Ref.	Estuche	U/Vta	U/Emb
10204978	0612610	10 uds	1	96
10203933	0612624	24 uds	1	48



Rotuladores punta pincel Estuche de 6

Código	Ref.	Color	U/Vta	U/Emb
10204448	0612606MET	Metal	1	12
10204447	0612606FL	Flúor	1	12



Lápices de colores acquarelables Estuche de metal

Código	Ref.	Estuche	U/Vta	U/Emb
12802551	07468112C	12 uds	1	96
12802552	07468124C	24 uds	1	96

MILAN® ART



Difumino

Código	Ref.	Artículo	U/Vta	U/Emb
17601000	2800412	46 mm	12	3000
17601001	2810412	69 mm	12	2400
17601002	2820412	105 mm	12	960
17601004	2830412	125 mm	12	720



Carboncillo redondo

Código	Ref.	Artículo	Caja	U/Vta	U/Emb
15601001	7800	3-5 mm	5 uds	1	100
15601002	4403	6-8 mm	3 uds	1	180
15601010	7804	9-11 mm	5 uds	1	300

Carboncillo rectangular 15x4mm Caja de 6

Código	Ref.	U/Vta	U/Emb
15601017	2716106	1	300



Goma de borrar maleable 1220 para borrar carboncillo

Código	Ref.	U/Vta	U/Emb
11101087	CCM1220-12	1	400



Lápices de dibujo blancos Caja de 3

Código	Ref.	U/Vta	U/Emb
12802549	07B222103	1	12



Pincel de agua con depósito recargable Caja de 3

Código	Ref.	U/Vta	U/Emb
12301420	04C403	1	



Lápices de grafito acquarelables Estuche de metal de 3 (HB, 4B y 8B)

Código	Ref.	U/Vta	U/Emb
12802550	07168103C	1	



Bolígrafo Terra 1,0mm

Código	Ref.	Color	U/Vta	U/Emb
10101875	41101008	Azul	1	50
10101874	41101007	Negro	1	50
10101876	41101009	Rojo	1	50



Bolígrafo Pen 1,0mm

Código	Ref.	Color	U/Vta	U/Emb
10101878	41101005	Azul	1	12
10101877	41101004	Negro	1	12
10101879	41101006	Rojo	1	12



RECARGABLE

Bolígrafo Rocker antibacteriano Expositor de 18

Código	Ref.	U/Vta	U/Emb
30301942	42101016	1	18



RECARGABLE

40% BIO

Bolígrafo Rocker Bio Expositor de 18

Código	Ref.	U/Vta	U/Emb
30301941	42101014	1	18



Portaminas Graphite 0,7mm HB

Código	Ref.	U/Vta	U/Emb
12501166	41301001	1	12



Minas HB Tubo de 24

Código	Ref.	Artículo	U/Vta	U/Emb
21901010	41501009	0,5 mm	1	24
21901090	41501008	0,7 mm	1	24



Recambio punta normal

Código	Ref.	Color	U/Vta	U/Emb
25402009	41502003	Azul	1	25
25402010	41502004	Negro	1	25



Tinta estilográfica Caja de 6 cartuchos

Código	Ref.	Color	U/Vta	U/Emb
10601000	41505001	Azul	1	12
10601001	41505002	Negro	1	12



Tinta estilográfica 30ml

Código	Ref.	Color	U/Vta	U/Emb
10601238	15901002	Azul	1	1
10601237	15901001	Negro	1	1
10601294	15901003	Azul claro	1	1
10601295	15901004	Rojo vino	1	1
10601296	15901005	Verde bosque	1	1
10601297	15901006	Madera oscura	1	1
10601298	15901007	Violeta	1	1



SIN DISOLVENTES
SEM SOLVENTES



Barra de Pegamento

Código	Ref.	Tamaño	U/Vta	U/Emb
23102001	1584622	Pequeña 11g	15	150
23102002	1584625	Mediana 22g	15	150
23102003	1584626	Grande 43g	15	150



Barra Pegamento Mediana 22g
Expositor de 40 unidades

Código	Ref.	U/Vta	U/Emb
23102073	2763929	1	1

Pritt contribuye a la reducción del plástico en plastificadas al año con su nuevo blister sin plástico



Barra Pegamento Grande 43g
Expositor de 30 unidades

Código	Ref.	U/Vta	U/Emb
23102074	1661879	1	1

90% INGREDIENTES NATURALES*



Cola Blanca

Código	Ref.	Tamaño	U/Vta	U/Emb
23101109	2769976	100 gr	6	24
23101243	1869963	250 gr	1	24
23101110	1869962	1 kg	1	12



Aplicación ancha



Aplicación precisa



Cola Universal, de 100g

Código	Ref.	U/Vta	U/Emb
23103081	2802666	1	15



Masilla adhesiva MULTITAC
65 unidades

Código	Ref.	U/Vta	U/Emb
23104058	2679461	24	24



Corrector Casete Mini
4,2 mm x 7 m

Código	Ref.	U/Vta	U/Emb
15103024	2683082	10	40



Corrector cinta Micro Rolli
5 mm x 6 m

Código	Ref.	U/Vta	U/Emb
15103212	2683083	15	60



Corrector cinta Compact Flex
4,2 mm x 10 m

Código	Ref.	U/Vta	U/Emb
15101055	2683113	24	96



Corrector cinta Eco Flex
4,2 mm x 10 m

Código	Ref.	U/Vta	U/Emb
15101039	2683109	10	40



Roller Compact - Pegamento

Código	Ref.	Tamñ	U/Vta	U/Emb
23101039	2111694	Permanente	8	32
23101045	2111972	No Permanente	8	32

LOCTITE



Pegamento instantáneo Super Glue-3
3 gr

Código	Ref.	U/Vta	U/Emb
23103008	2640968	30	40



Pegamento instantáneo Super Glue-3
5 gr Precisión

Código	Ref.	U/Vta	U/Emb
23103009	2640076	12	12



Pegamento instantáneo Super Glue-3
5 gr con píncel

Código	Ref.	U/Vta	U/Emb
23103019	2640969	15	21



Pegamento instantáneo Super Glue-3
Monodosis 3 x 1 gr

Código	Ref.	U/Vta	U/Emb
23103084	2640065	12	12



Pegamento instantáneo Super Glue-3
Creative 3 gr

Código	Ref.	U/Vta	U/Emb
23101043	2646189	1	12



Pegamento instantáneo Super Glue-3
XXL 20g

Código	Ref.	U/Vta	U/Emb
23103010	2646770	12	1



Pegamento universal 60 segundos
20g

Código	Ref.	U/Vta	U/Emb
23101020	2066112	1	12

INSTANT



Corrector líquido
*Punta de metal

Código	Ref.	Artículo	U/Vta	U/Emb
15103232	51301	Bote 20ml	10	240
15103231	90811	Bolígrafo 9ml*	12	576



Barra de pegamento Classic

Código	Ref.	Artículo	U/Vta	U/Emb
23102075	10001	5g	16	160
23102051	11311	10g	24	576
23102052	12311	20g	24	432
23102053	13001	40g	12	192



Barra de pegamento Educa Color

Código	Ref.	Artículo	U/Vta	U/Emb
23102055	12361	20g	24	432
23102056	13301	40g	12	192



Barra de pegamento Pastel 20g

Código	Ref.	U/Vta	U/Emb
23101253	16601	12	120



Barra de pegamento Gluxtreme 20gr

Código	Ref.	U/Vta	U/Emb
23101279	15971	12	144



Cola líquida Gluxtreme 147gr

Código	Ref.	U/Vta	U/Emb
23101280	15981	6	72



Cola transparente líquida Superclear

Código	Ref.	Artículo	U/Vta	U/Emb
23101152	11091	147ml	12	72
23101153	11141	266ml	6	48



Cola blanca ECO

Código	Ref.	Artículo	U/Vta	U/Emb
23101103	20701	40g	12	144
23101101	20711	100g	12	144
23101102	20721	250g	6	48



Cola transparente Eco 1000g

Código	Ref.	U/Vta	U/Emb
23101151	20611	1	12



Cola líquida transparente 35ml
Doble punta

Código	Ref.	U/Vta	U/Emb
23101113	10761	24	288



Cola líquida blanca 35ml
Doble punta

Código	Ref.	U/Vta	U/Emb
23101114	10771	24	288



Masilla adhesiva blanca 50grs

Código	Ref.	U/Vta	U/Emb
23104064	10791	15	300

INSTANT



Témpera Playcolor Metallic sólida
Estuche de 6

Código	Ref.	Artículo	U/Vta	U/Emb
27401378	10351	Estuche Pocket 5gr	1	24
27401375	10321	Estuche One 10gr	1	24



Témpera Playcolor Basic Pocket sólida 5g
Colores surtidos

Código	Ref.	Artículo	U/Vta	U/Emb
27401371	10521	Estuche 12uds	1	24
27401370	10511	Estuche 6uds	1	24



Témpera Playcolor Basic One sólida 10g
Colores surtidos

Código	Ref.	Artículo	U/Vta	U/Emb
27401313	10731	Estuche 12uds	1	24
27401314	10711	Estuche 6uds	1	24
27401397	10901	Classbox 144uds	1	1



Témpera Playcolor Fluo Playcolor sólida
Estuche de 6

Código	Ref.	Artículo	U/Vta	U/Emb
27401394	10421	Estuche Pocket 5gr	1	24
27401393	10431	Estuche One 10gr	1	24



Témpera Playcolor Textil One sólida

Código	Ref.	Artículo	U/Vta	U/Emb
27401390	10501	Estuche Pocket 6uds 5gr	1	24
27401391	10561	Estuche Pocket 12uds 5gr	1	24
27401387	10401	Estuche One 6uds 10gr	1	24
27401388	10461	Estuche One 12uds 10gr	1	24



Témpera sólida One Playcolor Window 10gr.

Código	Ref.	Artículo	U/Vta	U/Emb
27401004	02001	6 colores	1	24
27401144	02011	12 colores	1	24



Témpera sólida Playcolor Pastel 10gr
Estuche de 6

Código	Ref.	U/Vta	U/Emb
27401667	18401	1	24



Pintura de dedos Playcolor Basic 40ml
Estuche de 6

Código	Ref.	U/Vta	U/Emb
23501518	17591	1	12



Témpera líquida Playcolor Pastel 40ml
Estuche de 6

Código	Ref.	U/Vta	U/Emb
27401661	16801	6	12



Témpera líquida Playcolor bote 40ml
Estuche de 6

Código	Ref.	Color	U/Vta	U/Emb
27401670	20221	Glitter	1	12
27401671	20111	Fluo	1	12



Témpera líquida Playcolor bote 40ml
Estuche surtido

Código	Ref.	Artículo	U/Vta	U/Emb
27401626	19931	6 colores	1	12
27401627	19941	12 colores	1	6

INSTANT



Témpera Líquid Playcolor líquida
Botella de 1000ml

Código	Ref.	Color	U/Vta	U/Emb
27401605	19481	Bianco	6	6
27401606	19491	Amarillo	6	6
27401607	19501	Naranja	6	6
27401608	19511	Rojo	6	6
27401609	19521	Carne	6	6
27401610	19531	Magenta	6	6
27401611	19541	Verde claro	6	6
27401612	19551	Verde oscuro	6	6
27401613	19561	Azul claro	6	6
27401614	19571	Azul oscuro	6	6
27401615	19581	Violeta	6	6
27401616	19591	Marrón	6	6
27401617	19601	Negro	6	6

R
Regalo

POR LA COMPRA
de 18 BOTELLAS
SURTIDAS DE 1000ML
EXPOSITOR VACÍO
DE REGALO



Témpera Líquid Playcolor líquida 1000ml
Expositor VACÍO

Código	Ref.	U/Vta	U/Emb
27401662	12641	1	1



Cola 180ml
Expositor de 6 surtido

Código	Ref.	Artículo	U/Vta	U/Emb
23101174	14691	Superclear	1	8
23101173	14391	Color	1	8
23101175	14871	Metal	1	8



Cola 180ml
6 colores surtidos

Código	Ref.	Artículo	U/Vta	U/Emb
23101157	11271	Glitter	6	48
23101254	16401	Pastel	1	48
23101255	14581	Galaxi	1	48
23101256	14481	Neón	1	48



Cola Glow luminiscente 147ml
3 colores surtidos

Código	Ref.	U/Vta	U/Emb
23101156	15271	6	48



Pintura acrílica Playcolor 40ml
Caja de 6

Código	Ref.	Color	U/Vta	U/Emb
27401672	20311	Metálico	1	12
27401673	20521	Pastel	1	12



Pintura acrílica Basic Playcolor
Caja de 6 colores surtidos
(blanco, amarillo, rojo, verde, azul y negro)

Código	Ref.	Artículo	U/Vta	U/Emb
27401622	18191	Bote 40ml	1	12
27401623	18161	Basket - 250ml	1	1



Maquillaje Playcolor Pocket 5gr
Caja de 6

Código	Ref.	Artículo	U/Vta	U/Emb
30001098	01001	Colores básicos	1	12
30001099	01011	Colores metálicos	6	12



Roller adhesivo casete especial goma EVA

Código	Ref.	U/Vta	U/Emb
23104072	25351	12	144



plico



Masilla adhesiva Blu-Tack

Código	Ref.	Artículo	U/Vta	U/Emb
23104001	1689	Azul - Original	12	216
23104044	1739	Blanco - Cuarteado	12	216



Masilla adhesiva Blu-Tack Azul Formato escolar

Código	Ref.	U/Vta	U/Emb
23101147	1690	1	12



Punto adhesivos Punto Tack 64 uds

Código	Ref.	U/Vta	U/Emb
23104067	1693	12	72



Pegamento Universal Bostik Contact 55ml

Código	Ref.	U/Vta	U/Emb
23101123	1631	12	12



Pegamento universal doble punta transparente 30ml

Código	Ref.	U/Vta	U/Emb
23101196	13360	12	12



Silicona líquida

Código	Ref.	Artículo	U/Vta	U/Emb
23101069	13354	100ml	1	12
23101195	13357	500ml	1	12
23101281	13355	1000ml	12	12



Discos de cierre adhesivos 20ø Macho/hembra

• 400 conjuntos

Código	Ref.	Color	U/Vta	U/Emb
11901442	13334	Blanco	1	12
11901453	13335	Negro	1	12
11901454	13336	Rojo	1	12
11901455	13337	Verde	1	12

• 200 conjuntos

Código	Ref.	Color	U/Vta	U/Emb
11901452	13338	Blanco	1	12
11901456	13339	Negro	1	12
11901457	13340	Rojo	1	12
11901458	13341	Verde	1	12



Mini cierre textil adhesivo Quita y Pon 24 uds.

Código	Ref.	U/Vta	U/Emb
25208752	13302	12	72



Cierre textil adhesivo blanco

Código	Ref.	Medida	U/Vta	U/Emb
11901321	13330	10m x 20mm	1	6
11901320	13318	25m x 20mm	1	6



Cinta adhesiva doble cara
rollo 20m x 5mm Ultra estrecha

Código	Ref.	U/Vta	U/Emb
11901356	13310	1	20



Cinta adhesiva doble cara
rollo 20m x 50mm Máxima anchura

Código	Ref.	U/Vta	U/Emb
11901357	13321	1	10



Cinta adhesiva doble cara
rollo 2m x 15mm espuma efecto 3D

Código	Ref.	U/Vta	U/Emb
11902075	13313	1	20



Cinta adhesiva doble cara en rollo
Ultrafina

Código	Ref.	Medida	U/Vta	U/Emb
11902073	13311	20m x 9mm	1	20
11902074	13312	20m x 15mm	1	20
11902079	13320	20m x 30mm	1	10
11901459	13319	50m x 15mm	8	20
11901460	13322	50m x 30mm	1	20



Cinta adhesiva doble cara
rollo 3m x 20mm Ultra Tack

Código	Ref.	U/Vta	U/Emb
11901354	13308	1	10



Piezas adhesivas doble cara
Ultra Tack 30x34mm

Código	Ref.	U/Vta	U/Emb
11901385	13307	12	12



Cinta adhesiva doble cara
rollo 50m x 12/18mm Fácil uso

Código	Ref.	U/Vta	U/Emb
11901355	13309	1	10



Cinta de pintor Baja Adhesión
24mm x 50m

Código	Ref.	U/Vta	U/Emb
11901498	13305	1	10



Cinta de pintor Especial Curvas
24mm x 25m

Código	Ref.	U/Vta	U/Emb
11901499	13306	1	10



Cinta de pintor

Código	Ref.	Medida	U/Vta	U/Emb
11901411	13325	30m x 30mm	1	10
11901461	13329	95m x 30mm	1	8



Imán Tack. cinta adhesiva imantada
1m x 20mm

Código	Ref.	U/Vta	U/Emb
11901319	13314	1	20



Cinta adhesiva magnética Iman Tack
Materiales ligeros. 3m x 19mm

Código	Ref.	U/Vta	U/Emb
11901417	13327	12	12



Cinta adhesiva magnética Iman-Tack 24 piezas
Máxima resistencia. 20 x 20mm

Código	Ref.	U/Vta	U/Emb
11901418	13328	8	8



Pistola de cola Termofusible Mini 25W

Código	Ref.	U/Vta	U/Emb
23101121	1640	1	6



Cola termofusible, barritas mini

Código	Ref.	Artículo	Blíster	U/Vta	U/Emb
23101122	1641	25W	22 uds	1	10
23101194	1647	Extra larga	25 uds	1	10



Cola termofusible barritas mini Blíster de 22

Código	Ref.	Artículo	U/Vta	U/Emb
23101026	1638	Purpurina	1	10
23101029	1639	Flúor	1	10



Pistola de cola Termofusible Mini 25W Baja temperatura

Código	Ref.	U/Vta	U/Emb
23101148	1650	1	6



Cola termofusible mini Baja temperatura Blíster de 22

Código	Ref.	U/Vta	U/Emb
23101149	1651	1	10



Pistola de cola termofusible MAX 60w

Código	Ref.	U/Vta	U/Emb
23101027	1642	1	4



Cola termofusible barritas Max

Código	Ref.	Blíster	U/Vta	U/Emb
23101028	1643	12 uds	1	10
23101068	1644	25 uds	1	5



Cola termofusible barra Max-XL Blíster de 12

Código	Ref.	U/Vta	U/Emb
23101282	1645	1	10



Pistola de cola termofusible MAX PRO 100w

Código	Ref.	U/Vta	U/Emb
23101458	1652	1	1



Cola termofusible barra Max-XL Alta resistencia (Ø11,5mm x 200mm)

Código	Ref.	Blíster	U/Vta	U/Emb
23101456	1653	12 uds	10	10
23101457	1654	24 uds	5	5



98% fórmula natural

Barra de pegamento

Código	Ref.	Producto	U/Vta	U/Emb
23102038	7000568	Grande 40gr	12	192
23102037	7000569	Mediana 21gr	12	12
23102036	7000570	Pequeña 8gr	24	24



Pegamento universal ReNATURE 35ml Gira y pega

Código	Ref.	U/Vta	U/Emb
23101445	7001491	12	12

Barra de pegamento ReNATURE 21g

Código	Ref.	U/Vta	U/Emb
23101443	7001478	12	12



Pegamento universal Banda Azul tubo 35ml

Código	Ref.	U/Vta	U/Emb
23103052	63732	24	144

SIN DISOLVENTES



Pegamento universal ReNATURE Banda Azul tubo 35ml

Código	Ref.	U/Vta	U/Emb
23101364	7001494	24	144



Cola blanca escolar

Código	Ref.	Artículo	U/Vta	U/Emb
23101441	7001593	40g	12	12
23101442	7001592	125g	12	12



Masilla adhesiva blanca Patafix removible 80 uds

Código	Ref.	U/Vta	U/Emb
23101446	7001466	12	12



Masilla adhesiva transparente Patafix removible 56 uds

Código	Ref.	U/Vta	U/Emb
23101447	7001471	12	12





Pegamento instantáneo Súper rápido

Código	Ref.	Artículo	U/Vta	U/Emb
23101451	7001485	Mini 3x1g	10	10
23101450	7001484	3g	10	10
23101452	7001486	Pincel 5g	6	6



Corrector líquido bolígrafo 8ml

Código	Ref.	U/Vta	U/Emb
15101127	7001467	12	12



Corrector cinta 5mm x 10m

Código	Ref.	U/Vta	U/Emb
15101128	7001468	12	12



Cola glitter glue lápiz de 10ml

Código	Ref.	Artículo	U/Vta	U/Emb
23101448	7001469	Original - 6 colores	10	10
23101449	7001470	Glitter - 5 colores	10	10



Pegamento en spray 3 en 1

Código	Ref.	Tamaño	U/Vta	U/Emb
23103034	63272	200 ml	1	144
23103050	63274	500 ml	1	48



Pegamento universal súper Strong&Safe 7gr

Código	Ref.	U/Vta	U/Emb
23103066	34997	12	144

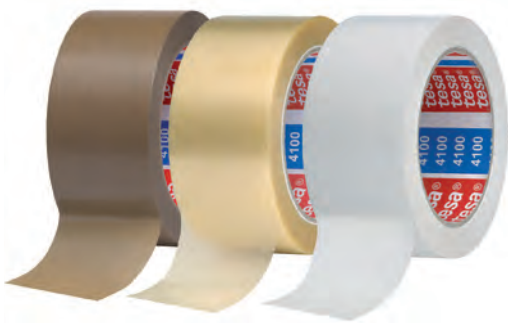

Cinta de embalaje PVC
Rollo 66m x 50mm

Código	Ref.	Artículo	U/Vta	U/Emb
11901021	04100-00034-00	Blanco	6	36
11901019	57145-00000-00	Marrón	6	36
11901018	57144-00000-00	Transparente	6	36



Rollo embalaje Tesapack®
Rollo 50m x 50mm

Código	Ref.	U/Vta	U/Emb
11901998	57180-00000-02	6	36



Cinta de embalaje transparente
Pet Eco & Ultra Strong
Rollo 66m x 50mm

Código	Ref.	U/Vta	U/Emb
11901501	58297-00000-00	36	36



Cinta de embalaje Basic PP
Rollo 66m x 50mm

Código	Ref.	Color	U/Vta	U/Emb
11903013	58570-00000-00	Transparente	6	36
11903014	58571-00000-00	Marrón	6	36

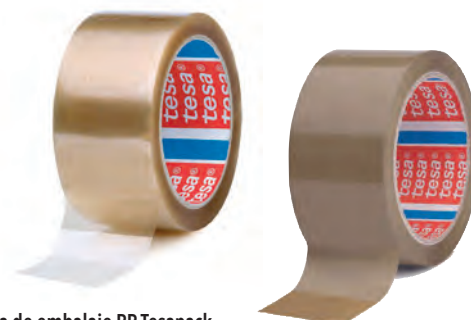

Cinta de embalaje PP Tesapack

Código	Ref.	Color	Medida	U/Vta	U/Emb
11901051	04089-00001-06	Transparente	65m x 50mm	36	36
11901039	04089-00006-06	Marrón	65m x 50mm	36	36
11901380	04089-00042-06	Transparente	132m x 50mm	36	36
11901381	04089-00106-06	Marrón	132m x 50mm	36	36

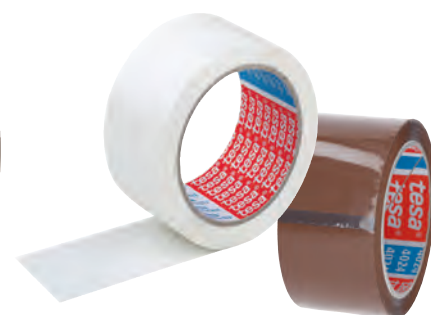

Cinta de embalaje Poliolefina
Rollo 66m x 50mm

Código	Ref.	Color	U/Vta	U/Emb
11901324	04024-00209-02	Blanco	36	36
11901999	04024-00234-04	Transparente	6	36
11901382	04024-00235-04	Marrón	36	36



Cinta de embalaje PP NOPI
Rollo 66m x 48mm

Código	Ref.	Artículo	U/Vta	U/Emb
11901003	64264-00001-00	Marrón	6	36
11901017	64264-00000-00	Transparente	6	36



CON
DISPENSADOR

Cinta de embalaje standard transparente
66mx50mm
Pack de 2

Código	Ref.	U/Vta	U/Emb
11901095	57195-00000-01	1	10



Cinta de pintor Krepp 60°C

Código	Ref.	Artículo	U/Vta	U/Emb
11901261	04323-00006-00	50mx19mm	16	96
11901141	04323-00008-00	50mx25mm	12	72
11901274	04323-00009-00	50mx30mm	10	60



Máquina de cerrar bolsas y cintas de colores surtidos

Código	Ref.	Artículo	U/Vta	U/Emb
21702066	06256-00000-02	Máquina de cerrar bolsas	1	25
11901187	62204-00014-00	Cinta 66 x 12 Amarillo	12	144
11901058	62204-00008-00	Cinta 66 x 12 Azul	12	144
11901234	62204-00086-00/04204	Cinta 66 x 12 Blanco	12	144
11901185	62204-00001-00	Cinta 66 x 12 Rojo	12	144
11901186	62204-00011-00	Cinta 66 x 12 Verde	12	144
11901136	62204-00007-00	Cinta 66 x 9 Azul	16	192
11901188	62204-00000-00	Cinta 66 x 9 Rojo	16	192
11901189	62204-00010-00	Cinta 66 x 9 Verde	16	192



Pegamento en spray 500ml

Código	Ref.	Color	U/Vta	U/Emb
23103067	60021-00000-02	Permanente	1	12
23103068	60022-00000-02	Extra fuerte	1	12



Cinta adhesiva doble cara rollo 1,5m x 19mm
Powerbond montaje ultra fuerte

Código	Ref.	U/Vta	U/Emb
11901291	55791-00002-01	12	72



Cinta adhesiva doble cara powerbond rollo 1,5m x 19mm universal

Código	Ref.	U/Vta	U/Emb
11901044	58565-00001-00	12	72



Clavo adhesivo ajustable 1kg
Para paredes pintadas y yeso

Código	Ref.	U/Vta	U/Emb
31701023	77774-00001-00	1	128



Clavo adhesivo ajustable 3kg
Para azulejo y metal

Código	Ref.	U/Vta	U/Emb
31701024	77764-00001-00	1	128



Cable Velcro Manager negro 5m x 10mm

Código	Ref.	U/Vta	U/Emb
11901258	55239-00000-01	1	96



Cable Velcro Manager Small
5 colores surtidos

Código	Ref.	U/Vta	U/Emb
11901257	55236-00000-01	12	54



Cinta adhesiva doble cara para moquetas
extra fuerte, rollo de 5m x 50mm

Código	Ref.	U/Vta	U/Emb
11901132	05670-00000-11	1	72



Cinta doble cara rollo 2,75m x 38mm

Código	Ref.	U/Vta	U/Emb
11901236	56665-00001-01	6	72



Portarrollos Easy Cut Smart 33m + 4 rollos Tesafilm transparente

Código	Ref.	Color	U/Vta	U/Emb
16601024	53908-00000-00	Azul	1	6
16601025	53909-00000-00	Rosa	1	6



Portarrollos Curve 33m + 1 rollo Tesafilm transparente 10mx19mm

Código	Ref.	U/Vta	U/Emb
16601026	53917-00000-00	1	9



Rollo corte sin tijeras 25m x 19mm

Código	Ref.	Artículo	U/Vta	U/Emb
11901107	57521-00000-01	Bolsa de 1	24	192
11901233	57520-00001-03	Blistér	12	72



Rollo Standard

Código	Ref.	Artículo	U/Vta	U/Emb
11901015	57383-00000-04	10mx15mm mini	100	100
11901022	57381-00001-01	33m x 15mm	30	240
11901030	57225-00001-01	33m x 19mm	24	192
11901032	57382-00001-01	66m x 15mm	10	120
11901052	57226-00001-01	66m x 19mm	8	96



Cinta Adhesiva Basic Transparent

Código	Ref.	Artículo	U/Vta	U/Emb
11901311	58542-00000-00	33mx15mm	30	240
11901312	58544-00000-00	33mx19mm	24	192
11901313	58545-00000-00	66mx19mm	8	64
11901315	58568-00000-00	33mx15mm*	1	48

*Torre de 10



Rollo Transparente

Código	Ref.	Artículo	U/Vta	U/Emb
11901012	57352-00004-01	33m x 15mm	12	144
11901054	57378-00003-00	33m x 19mm	10	120
11901016	57342-00008-00	66m x 15mm	10	60
11901053	57369-00005-01	66m x 19mm	8	48



Rollo Invisible 33m x 19mm

Código	Ref.	U/Vta	U/Emb
11901080	57312-00008-02	10	120



Cinta adhesiva doble cara transparente 7,5m x 12mm con mini portarrollos

Código	Ref.	U/Vta	U/Emb
11901227	57912-00000-02	10	80



Cinta adhesiva transparente doble cara 10 m x 15 mm

Código	Ref.	U/Vta	U/Emb
11901226	64623-00000-00	12	72



Cinta adhesiva Tesafilm Neón rollo 10m x 19mm
2 colores surtidos (amarillo o rosa)

Código	Ref.	U/Vta	U/Emb
11901383	53930-00000-00	1	20
11901384	53931-00000-00*	1	14

*Incluye Mini Portarrollos



Barra de pegamento Basic

Código	Ref.	Artículo	U/Vta	U/Emb
23101024	58559-00000-02	21g	24	288
23101022	58561-00000-02	36g	12	144



Pegamento Supergen en tubo

- TRANSPARENTE

Código	Ref.	Artículo	U/Vta	U/Emb
23103005	62602-00000-01	20 ml	24	240

- CONTACTO

Código	Ref.	Artículo	U/Vta	U/Emb
23103006	62600-00000-03	20 ml	24	240
23103007	62600-00000-04	40 ml	24	240
23103037	62600-00000-05	75 ml	24	96
23103063	62601-00000-03	Incoloro 20 ml	24	240
23101051	62601-00000-04	Incoloro 40 ml	24	240
23103098	62601-00000-05	Incoloro 75 ml	24	96



Corrector Basic 5mm x 8m

Código	Ref.	U/Vta	U/Emb
15103263	58563-00000-00	24	576



Corrector Casete Basic Mini 4mm x 6m

Código	Ref.	U/Vta	U/Emb
15103276	58564-00000-00	24	576



Corrector Casete Ambidiestro, 4,2 mm x 10 m

Código	Ref.	U/Vta	U/Emb
15103222	59812-00000-01	10	200



Roller corrector mini desechable
6m x 5mm
Colores surtidos

Código	Ref.	U/Vta	U/Emb
15103266	59816-00000-00	32	192



Roller adhesivo permanente mini ecológico
6m x 5mm
Expositor de 16

Código	Ref.	U/Vta	U/Emb
23101036	59819-00000-00	1	1



Roller adhesivo permanente ecológico
8,4m x 8,5mm

Código	Ref.	U/Vta	U/Emb
23104012	59090-00005-03	10	180



Sello adhesivo permanente

Código	Ref.	U/Vta	U/Emb
23101052	59099-00000-00	8	64

HASTA 1100
ESTAMPACIONES



Barra de pegamento
Blister de 3

Código	Ref.	Artículo	U/Vta	U/Emb
23101463	2510	21g	12	144
23101465	2512	40g	12	72



Barra de pegamento

Código	Ref.	Artículo	U/Vta	U/Emb
23101462	2509	21g + 15g	12	144
23101464	2511	40g + 9g	12	144



Barra de pegamento 9g
Blister de 2

Código	Ref.	U/Vta	U/Emb
23101332	2474	12	144

Barra de pegamento

Código	Ref.	Artículo	U/Vta	U/Emb
23101335	2417	21g - Bandeja de 24	1	12
23101336	2418	36g - Bandeja de 12	1	24
23101394	2501	21g - Expositor de 24	1	24
23101395	2502	36g - Expositor de 12	1	12



Pegamento universal 20ml

Código	Ref.	U/Vta	U/Emb
23101267	2429	1	8



Pegamento instantáneo

Código	Ref.	Artículo	U/Vta	U/Emb
23101258	2400	3g	1	24
23101308	2408	3g gel	12	288
23101259	2403	3 x 1g	1	12
23101260	2416	7g con pincel	1	12



Cola de contacto 20ml

Código	Ref.	U/Vta	U/Emb
23101266	2420	1	8



Cola blanca para madera

Código	Ref.	Artículo	U/Vta	U/Emb
23101263	2437	125g	1	72
23101264	2438	250g	1	72
23101262	2425	500g	1	12
23101265	2439	750g	1	12
23101392	2478	1000g	6	6



Cola blanca escolar

Código	Ref.	Artículo	U/Vta	U/Emb
23101261	2423	60g	1	144
23101316	2427	120g	12	144
23101317	2426	250g	6	72
23101393	2797	500g	6	24
23101318	2718	1000g	12	12



Pegamento para tejidos 20ml

Código	Ref.	U/Vta	U/Emb
23101311	2414	12	72



ESPECIAL GOMA EVA

Silicona líquida

Código	Ref.	Artículo	U/Vta	U/Emb
23101313	2470	60 ml	12	12
23101314	2493	100 ml	12	12
23101315	2708	250 ml	6	6

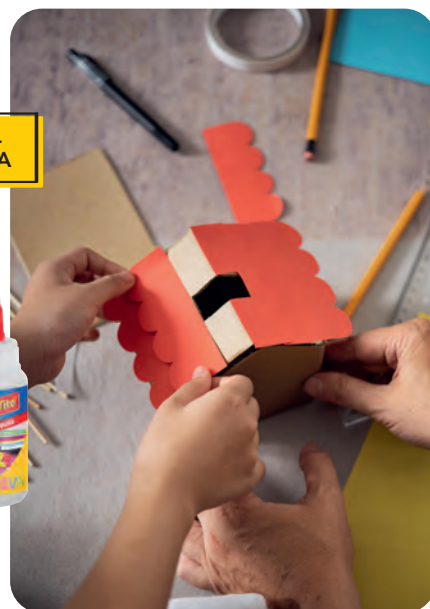

Juego slime Starter pack Kit completo

Código	Ref.	U/Vta	U/Emb
23101330	2759	12	72



Juego Slime activador bote 260ml

Código	Ref.	U/Vta	U/Emb
23101401	2792	6	72



Cola purpurina glue en bote Expositor surtido de 12

Código	Ref.	Artículo	Color	U/Vta	U/Emb
23101325	2714	100 ml	Neón	1	72
23101323	2729	100 ml	Vivos	1	72
23101324	2713	100 ml	Metálicos	1	72



Cola brillo oscuridad bote 100ml Expositor de 12 (6 colores surtidos)

Código	Ref.	U/Vta	U/Emb
23101402	2730	1	72



Juego Slime bote 120g

Código	Ref.	Artículo	U/Vta	U/Emb
23101399	2737	Purpurina	4	64
23101400	2799	Transparente	4	64



Regla cuadradillo 15cm

Código	Ref.	U/Vta	U/Emb
25501010	461015	16	16

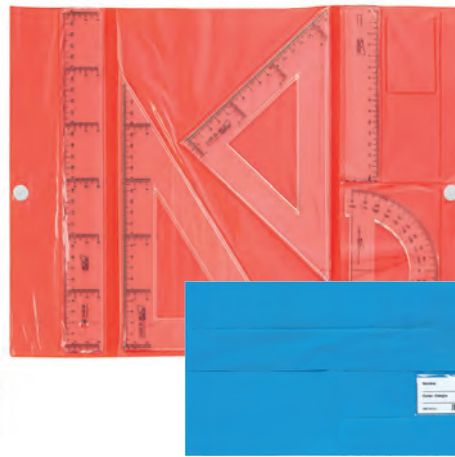

Equipo de dibujo cierre con velcro

Código	Ref.	U/Vta	U/Emb
18402005	940001	10	60

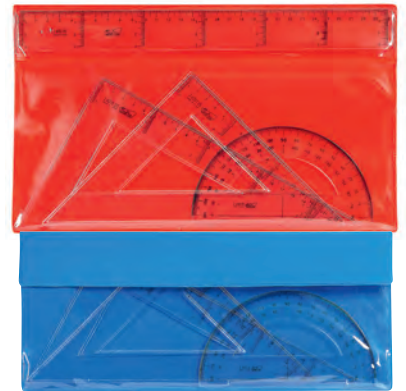

Equipo de dibujo 25cm

Código	Ref.	U/Vta	U/Emb
18402004	942001	10	60



Equipo de dibujo 25cm cierre con broche

Código	Ref.	U/Vta	U/Emb
18401059	941001	10	60



Estuche de dibujo reglas flexibles 3 colores surtidos

Código	Ref.	U/Vta	U/Emb
18401060	943901	12	96



Escuadra Verde

Código	Ref.	Tamaño	U/Vta	U/Emb
18401003	8201025	25cm	20	20
18401017	8201030	30cm	20	10



Cartabón Verdes

Código	Ref.	Tamaño	U/Vta	U/Emb
18403003	8202025	25cm	20	20
18403017	8202030	30cm	20	10



Reglas Verdes

Código	Ref.	Tamaño	U/Vta	U/Emb
25501004	800030	30cm	20	30
25501021	800040	40cm	20	20



Escuadra cristal

Código	Ref.	Tamaño	U/Vta	U/Emb
18401031	4201920	20 cm	20	30
18401033	4201925	25 cm	20	20
18401034	4201930	30 cm	20	10

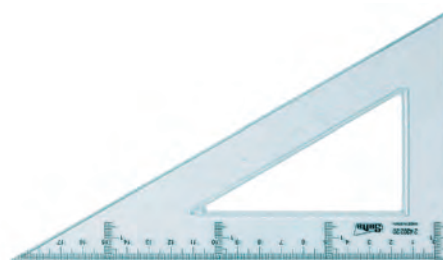

Cartabón cristal

Código	Ref.	Tamaño	U/Vta	U/Emb
18403031	4202920	20 cm	20	30
18403033	4202925	25 cm	20	20
18403034	4202930	30 cm	20	10

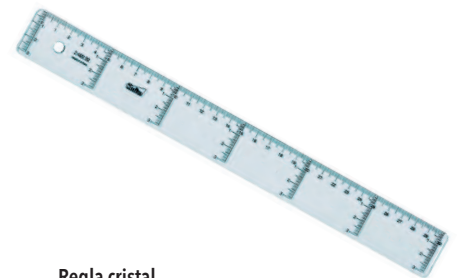

Regla cristal

Código	Ref.	Tamaño	U/Vta	U/Emb
25501040	400920	20 cm	20	35
25501041	400930	30 cm	20	30
25501042	400940	40 cm	20	20
25501043	400950	50 cm	20	15
25501044	400960	60 cm	20	10



Semicírculo cristal

Código	Ref.	Tamaño	U/Vta	U/Emb
26101000	430915	15 cm	20	25
26101005	430009	9 cm	20	60

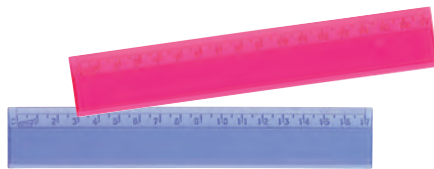

Regla cristal 17cm surtida

Código	Ref.	U/Vta	U/Emb
25501394	400917	20	25



Regla aluminio Expositor de 12

Código	Ref.	Tamaño	U/Vta	U/Emb
25501135	3422051059	20 cm	1	12
25501136	3422051060	30 cm	1	12



Pizarra blanca A4 surtido

Código	Ref.	U/Vta	U/Emb
23801848	3422051067	1	20



Set papelería 6 piezas Expositor de 20

Código	Ref.	U/Vta	U/Emb
12802483	3422051070	1	12



Adaptador para lápiz Expositor de 48

Código	Ref.	U/Vta	U/Emb
13601023	3422051073	1	48



Corrector cinta retráctil + pegamento Expositor de 12

Código	Ref.	U/Vta	U/Emb
15101131	3422051079	1	8



Corrector cinta retráctil Expositor de 12

Código	Ref.	U/Vta	U/Emb
15101130	3422051068	1	8



Goma de borrar pvc tricolor Expositor de 20

Código	Ref.	U/Vta	U/Emb
11101383	3422051078	1	10



Goma de borrar pvc Expositor de 20

Código	Ref.	U/Vta	U/Emb
11101381	3422051056	1	10



Goma de borrar extraíble forma de cutter Expositor de 36

Código	Ref.	U/Vta	U/Emb
11101382	3422051057	1	4



Grapadora mini
Expositor de 12

Código	Ref.	U/Vta	U/Emb
12901581	3422051069	1	8



Afilalápiz metálico

Código	Ref.	Tamaño	U/Vta	U/Emb
13701268	3422051050	Individual	36	360
13701269	3422051051	Doble	24	240



Afilalápiz surtido
Expositor de 48

Código	Ref.	U/Vta	U/Emb
13701267	3422051048	1	16



Afilalápiz doble con depósito
Expositor de 12

Código	Ref.	U/Vta	U/Emb
13701270	3422051054	1	12



Afilaborra surtido
Expositor de 36

Código	Ref.	U/Vta	U/Emb
13701272	3422051080	1	6



Afilaborra surtido
Expositor de 36

Código	Ref.	U/Vta	U/Emb
13701271	3422051055	1	6



Compás escolar con lápiz
Expositor de 10

Código	Ref.	U/Vta	U/Emb
16301085	3422051061	1	18



Compás escolar precisión
con adaptador universal
Expositor de 12

Código	Ref.	U/Vta	U/Emb
16301087	3422051063	1	4



Compás escolar
Expositor de 10

Código	Ref.	U/Vta	U/Emb
16301086	3422051062	1	18



Tijeras escolar 13cm
Expositor de 20

Código	Ref.	U/Vta	U/Emb
27601282	3422051065	1	12



Tijeras escolar plástico
Expositor de 20

Código	Ref.	U/Vta	U/Emb
27601281	3422051064	1	12



Portatodo de silicona purpura

Código	Ref.	Artículo	Descripción	U/Vta	U/Emb
62101862	312189974	Estrecho	Set de 12	1	1
62101863	312189975	Plano	Set de 12	1	1
62101864	312189976	Cuadrado	Set de 8	1	1
62101865	312189977	Redondo	Set de 8	1	1
62101861	312189973	Surtido	Set de 16	1	1



Portatodo de silicona, colores pastel

Código	Ref.	Artículo	Descripción	U/Vta	U/Emb
62003363	312089974	Estrecho	Set de 12	1	1
62003364	312089975	Plano	Set de 12	1	1
62003365	312089976	Cuadrado	Set de 8	1	1
62003366	312089977	Redondo	Set de 8	1	1
62003362	312089973	Surtido	Set de 16	1	1



16 MESES
Sept. 2023
Dic. 2024
Semana vista



Agenda Student 16 meses S/V decorada espiral
Tapa PP 12x17cm con goma
Expositor surtido de 24

Código	Ref.	U/Vta	U/Emb
82401135	10072231SD	1	1



16 MESES
Sept. 2023
Dic. 2024
Semana vista



Agenda Student 16 meses S/V lisa espiral
Tapa PP 12x17cm con goma
Expositor surtido de 18

Código	Ref.	U/Vta	U/Emb
82401137	180722310SD	1	1



Agenda escolar Student D/P lisa espiral
Tapa PP 12x17cm con goma
Expositor surtido de 18

Código	Ref.	U/Vta	U/Emb
82303620	180712310SD	1	1



Agenda escolar Student Prisma D/P espiral
Tapa PP 12x17cm con goma
Expositor surtido de 18

Código	Ref.	U/Vta	U/Emb
82303619	18071230SD	1	1

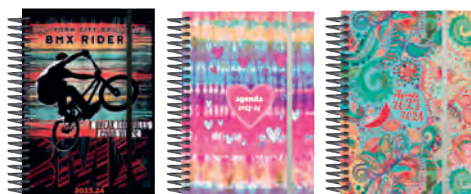

Agenda escolar Junior S/V espiral
Tapa PP 15,5x21cm con goma
Expositor surtido de 12

Código	Ref.	U/Vta	U/Emb
82303622	10073230SD	1	1



Agenda escolar Student D/P espiral
Tapa PP 12x17cm con goma
Expositor surtido de 48

Código	Ref.	U/Vta	U/Emb
82303618	10071230SD	1	1

SENFORT

RINGBOOKS

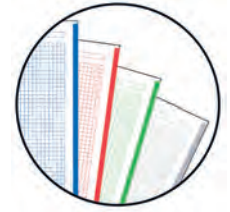

Ringbook Prisma A4 4 anillas mixtas 35mm con separadores y recambio de 120 hojas

Código	Ref.	Color	U/Vta	U/Emb
62302111	1808411	Azul	4	4
62302117	1808418	Turquesa	4	4
62302113	1808413	Verde	4	4
62302118	1808419	Rosa	4	4
62302114	1808417	Morado	4	4
62302116	1808415	Naranja	4	4
62302112	1808412	Rojo	4	4
62302115	1808414	Lima	4	4



POR LA COMPRA DE UN RINGBOOK PRISMA DE REGALO UNA AGENDA ESCOLAR*



12 MESES
Sept. 2023
Sept. 2024
1 Día/Pág.



* Agenda escolar Student D/P 17x12cm tapa polipropileno



Agenda escolar Premium A5 S/V
Expositor de 32

Código	Ref.	U/Vta	U/Emb
82303202	10839-23	1	2



Agenda escolar Premium A6 D/P
Expositor de 20

Código	Ref.	U/Vta	U/Emb
82303203	10835-23	1	2



18x Premium A5 S/V
10x Premium A6 D/P

Agenda escolar Premium Mixto
Expositor surtido de 28

Código	Ref.	U/Vta	U/Emb
82303201	10830-23	1	2



18x Sigma A5 S/V
12x Sigma A6 D/P

Agenda escolar Sigma mixto
Expositor de 30

Código	Ref.	U/Vta	U/Emb
82303204	50814-23	1	2



18x Nexus A5 S/V
12x Nexus A6 D/P

Agenda escolar Nexus mixto
Expositor de 30

Código	Ref.	U/Vta	U/Emb
82303205	50815-23	1	2



10x Sigma A5 S/V
8x Nexus A5 S/V
6x Sigma A6 D/P
6x Nexus A6 D/P

Agenda escolar Sigma/Nexus espiral
Expositor surtido de 30

Código	Ref.	U/Vta	U/Emb
82303206	50816-23	1	2

S/V: Semana vista.
D/P: Día página.



Agenda infantil perpetua A5
tapa extradura espiral

Código	Ref.	U/Vta	U/Emb
82303160	10945-23	1	2



Agenda escolar Sigma A5 S/V espiral
tapa extradura

Código	Ref.	Artículo	U/Vta	U/Emb
82303184	51143-23	Gris	1	40
82303182	51141-23	Rosa	1	40
82303181	51140-23	Turquesa	1	40
82303183	51142-23	Verde	1	40
82303185	10883-23	Surtido	1	40

Agenda escolar Sigma A6 D/P espiral
tapa extradura

Código	Ref.	Artículo	U/Vta	U/Emb
82303189	51148-23	Gris	1	40
82303187	51146-23	Rosa	1	40
82303186	51145-23	Turquesa	1	40
82303188	51147-23	Verde	1	40
82303190	10882-23	Surtido	1	40



Agenda escolar Nexus A5 S/V espiral
tapa polipropileno

Código	Ref.	Artículo	U/Vta	U/Emb
82303193	51527-23	Aloha	1	40
82303192	51526-23	Be Cool	1	40
82303191	51525-23	Bloom	1	40
82303194	51528-23	NYC	1	40
82303195	41182-23	Surtido	1	40

Agenda escolar Nexus A6 D/P espiral
tapa polipropileno

Código	Ref.	Artículo	U/Vta	U/Emb
82303198	51532-23	Aloha	1	40
82303197	51531-23	Be Cool	1	40
82303196	51530-23	Bloom	1	40
82303199	51533-23	NYC	1	40
82303200	41183-23	Surtido	1	40



Agenda escolar Premium Pink Panther A5 S/V wire-o
tapa extradura con goma

Código	Ref.	Artículo	U/Vta	U/Emb
82303162	51379-23	Team	1	20
82303161	51399-23	Stripes	1	20



Agenda escolar Premium Pink Panther A6+ D/P wire-o
tapa extradura con goma

Código	Ref.	Artículo	U/Vta	U/Emb
82303164	51380-23	Team	1	20
82303163	51400-23	Stripes	1	20



4 HOJAS DE PEGATINAS



4 HOJAS DE PEGATINAS

Agenda escolar Premium Nasa A5 S/V wire-o tapa extradura con goma

Código	Ref.	Artículo	U/Vta	U/Emb
82303166	51450-23	Flag	1	20
82303165	51419-23	Logo	1	20

Agenda escolar Premium Nasa A6+ D/P wire-o tapa extradura con goma

Código	Ref.	Artículo	U/Vta	U/Emb
82303168	51451-23	Flag	1	20
82303167	51420-23	Logo	1	20

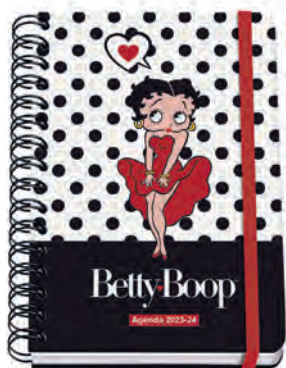

4 HOJAS DE PEGATINAS



Agenda escolar Premium Betty Boop wire-o tapa extradura con goma

Código	Ref.	Artículo	U/Vta	U/Emb
82303169	51359-23	A5 - S/V	1	20
82303175	51360-23	A6 - D/P	1	20



4 HOJAS DE PEGATINAS



Agenda escolar Premium WWF Save our Oceans wire-o tapa extradura con goma

Código	Ref.	Artículo	U/Vta	U/Emb
82303170	51434-23	A5 - S/V	1	20
82303176	51435-23	A6 - D/P	1	20



4 HOJAS DE PEGATINAS



Agenda escolar Premium Duo wire-o tapa extradura con goma

• Azul

Código	Ref.	Artículo	U/Vta	U/Emb
82303171	51504-23	A5 - S/V	1	20
82303177	51508-23	A6 - D/P	1	20

• Verde

Código	Ref.	Artículo	U/Vta	U/Emb
82303173	51506-23	A5 - S/V	1	20
82303179	51510-23	A6 - D/P	1	20

• Morado

Código	Ref.	Artículo	U/Vta	U/Emb
82303174	51507-23	A5 - S/V	1	20
82303180	51511-23	A6 - D/P	1	20

• Rosa

Código	Ref.	Artículo	U/Vta	U/Emb
82303172	51505-23	A5 - S/V	1	20
82303178	51509-23	A6 - D/P	1	20





N
Novedad

Mochila infantil Dragón

Código	Ref.	Color	U/Vta	U/Emb
62304717	51461	Azul	1	100
62304718	51462	Rosa	1	100



N
Novedad

Mochila infantil neopreno animales

Código	Ref.	Color	U/Vta	U/Emb
62304719	51459	Monkey	1	100
62304720	51460	Rabbit	1	100



**Portatodo flúor PVC
Expositor surtido de 20**

Código	Ref.	Artículo	U/Vta	U/Emb
62102222	51084	Plano	1	6
62102223	51082	Redondo	1	6



**Portatodo silicona purpura
Expositor surtido de 12**

Código	Ref.	U/Vta	U/Emb
62202739	51209	1	48



**Portatodo surtido
Expositor de 12**

Código	Ref.	Artículo	U/Vta	U/Emb
62003154	50996	Plano (poliester)	1	10
62003155	50997	Cuadrado (silicona)	1	10



**Bolígrafo Forest Elves retráctil
Expositor surtido de 36**

Código	Ref.	U/Vta	U/Emb
62202765	51212	1	36



N
Novedad

**Bolígrafo borrable Rain or Shine
Expositor surtido de 36**

Código	Ref.	U/Vta	U/Emb
62304723	51482	1	36



**Corrector cinta mini
Bote de 36**

Código	Ref.	U/Vta	U/Emb
15101089	30263	1	12



**Pasta de modelar Cute
7,5gr x 4 colores**

Código	Ref.	Artículo	U/Vta	U/Emb
24101432	19000	Plátano	1	12
24101433	19001	Sandía	1	12
24101434	19002	Uvas	1	12
24101435	19003	Fresas	1	12
24101436	19004	Cerdo	1	12
24101437	19005	León	1	12
24101438	19006	Abeja	1	12
24101439	19007	Oveja	1	12



**Taco de notas mini con formas neón
Bote de 30 (5 colores surtidos)**

Código	Ref.	U/Vta	U/Emb
26901371	75023	1	12



**Taco de notas mini con formas
Bote de 75**

Código	Ref.	U/Vta	U/Emb
26901372	75025	1	12



**Banderitas adhesivas
Expositor surtido de 21**

Código	Ref.	Artículo	U/Vta	U/Emb
26901374	75030	Frutas y animales	1	16
26901375	75034	Motivos en oro	1	16



**Taco de notas
Expositor surtido de 20**

Código	Ref.	U/Vta	U/Emb
26901376	75037	1	12



Agenda escolar Oxford&Me A5 Wire-O tapa extradura con goma
4 modelos surtidos

Código	Ref.	Formato	Ud/Vta	Ud/Emb
82303146	400173132	D/P	1	24
82303147	400173133	S/V	1	24



Agenda escolar Ice Explorer 8° D/P
espiral tapa extradura con goma
2 colores surtidos

Código	Ref.	Ud/Vta	Ud/Emb
82303140	400172789	1	8



Agenda escolar Never Give Up espiral tapa extradura
con goma, 2 colores surtidos

Código	Ref.	Formato	Ud/Vta	Ud/Emb
82303131	400172774	8° D/P	1	8
82303141	400172775	4° S/V	1	8



Agenda escolar So Chic 8° D/P espiral
tapa extradura con goma, 4 modelos surtidos

Código	Ref.	Ud/Vta	Ud/Emb
82303134	400172781	1	8



Agenda escolar Animal Print 8° espiral
tapa extradura con goma
3 modelos surtidos

Código	Ref.	Formato	Ud/Vta	Ud/Emb
82303132	400172777	D/P	1	8
82303133	400172778	S/V	1	8



Agenda escolar Daisy 8° D/P
espiral tapa extradura con goma
2 colores surtidos

Código	Ref.	Ud/Vta	Ud/Emb
82303139	400172787	1	8



Agenda escolar Japandi espiral tapa extradura con goma
4 colores surtidos

Código	Ref.	Formato	Idioma	U/Vta	U/Emb
82303135	400172783	8° D/P	CAST	1	8
82303137	400172785	8° S/V	CAST	1	8
82303138	400172786	4° S/V	CAST	1	10
82303136	400174244	8° D/P	CAT	1	8



Agenda escolar Live&Go 8° espiral
tapa plástico con goma
3 colores surtidos

Código	Ref.	Formato	Ud/Vta	Ud/Emb
82303142	400172771	D/P	1	8
82303143	400172772	S/V	1	8



Agenda escolar School espiral tapa extradura
5 colores surtidos

Código	Ref.	Formato	Idioma	U/Vta	U/Emb
82303116	400172744	8° D/P	CAST	1	8
82303117	400172745	8° S/V	CAST	1	8
82303118	400172746	4° S/V	CAST	1	10
82303119	400172747	8° D/P	CAT	1	8
82303120	400172748	4° S/V	CAT	1	10
82303121	400172749	8° D/P	EUSK	1	8



Agenda escolar Touch Pastel espiral tapa extradura con goma
4 modelos surtidos

Código	Ref.	Formato	Ud/Vta	Ud/Emb
82303128	400172766	8° D/P	1	8
82303129	400172767	8° S/V	1	8
82303130	400172768	4° S/V	1	10



Agenda escolar School espiral tapa polipropileno
4 colores surtidos

Código	Ref.	Formato	Idioma	U/Vta	U/Emb
82303122	400172760	8° D/P	CAST	1	8
82303123	400172761	8° S/V	CAST	1	8
82303124	400172762	4° S/V	CAST	1	10
82303125	400172763	8° D/P	CAT	1	8
82303126	400172764	4° S/V	CAT	1	10
82303127	400172765	8° D/P	EUSK	1	8



Agenda escolar Oxford&You 8° espiral tapa extradura con goma
4 modelos surtidos

Código	Ref.	Formato	Ud/Vta	Ud/Emb
82303144	400172769	D/P	1	8
82303145	400172770	S/V	1	8



- 5x 400172744 SCHOOL t.EXTRA 8° D/P
- 2x 400172745 SCHOOL t.EXTRA 8° S/V
- 4x 400172746 SCHOOL t.EXTRA 4° S/V
- 5x 400172760 SCHOOL t.PP 8° D/P
- 3x 400172761 SCHOOL t.PP 8° S/V
- 3x 400172762 SCHOOL t.PP 4° S/V
- 6x 400172766 TOUCH t.EXTRA 8° D/P
- 3x 400172767 TOUCH t.EXTRA 8° S/V
- 3x 400172768 TOUCH t.EXTRA 4° S/V
- 2x 400172771 LIVE&GO t.PP 8° D/P
- 2x 400172772 LIVE&GO t.PP 8° S/V

**Agenda escolar Básico
Expositor surtido de 38**

Código	Ref.	Ud/Vta	Ud/Emb
82303156	400174109	1	1



- 12x 400172747 SCHOOL t.EXTRA 8° D/P
- 7x 400172748 SCHOOL t.EXTRA 4° S/V
- 10x 400172763 SCHOOL t.PP 8° D/P
- 7x 400172764 SCHOOL t.PP 4° S/V

**Agenda escolar catalán
Expositor surtido de 36**

Código	Ref.	Ud/Vta	Ud/Emb
82303158	400174111	1	1



- 3x 400172774 NEVER GIVE UP 8° D/P
- 3x 400172775 NEVER GIVE UP 4° S/V
- 3x 400172777 ANIMAL PRINT t.EXTRA 8° D/P
- 3x 400172778 ANIMAL PRINT t.EXTRA 8° S/V
- 3x 400172781 SO CHIC t.EXTRA 8° D/P
- 3x 400172783 JAPANDI t.EXTRA 8° D/P
- 3x 400172785 JAPANDI t.EXTRA 8° S/V
- 3x 400172786 JAPANDI t.EXTRA 4° S/V
- 3x 400172787 DAISY t.EXTRA 8° D/P
- 3x 400172789 ICE EXPLORER t.EXTRA 8° D/P
- 3x 400172769 OXF&YOU t.EXTRA 8° D/P
- 3x 400172770 OXF&YOU t.EXTRA 8° S/V

**Agenda escolar Diseño
Expositor surtido de 36**

Código	Ref.	Ud/Vta	Ud/Emb
82303157	400174110	1	1



**Agenda escolar Identity espiral tapa extraduro
4 colores surtidos**

Código	Ref.	Formato	Idioma	Ud/Vta	Ud/Emb
82303148	400172800	8° D/P	CAST	1	20
82303149	400172802	4° S/V	CAST	1	32
82303151	400172804	4° D/P	CAST	1	16
82303150	400172803	4° S/V	CAT	1	32



**Agenda escolar Teens espiral tapa polipropileno
4 colores surtidos**

Código	Ref.	Formato	Idioma	Ud/Vta	Ud/Emb
82303152	400172805	8° D/P	CAST	1	20
82303153	400172806	4° S/V	CAST	1	32
82303155	400172808	4° D/P	CAST	1	16
82303154	400172807	4° S/V	CAT	1	32



Cuaderno de profesor Notas Evaluación surtido

Código	Ref.	Artículo	U/Vta	U/Emb
10001223	P102	A5	1	40
10003403	P112	A4	1	40



Cuaderno de profesor Tutoría A4 Asistencia y fichas de los alumnos surtido

Código	Ref.	U/Vta	U/Emb
10001900	P132	1	40



Cuaderno de profesor Duplex A4 Evaluación y tutoría surtido

Código	Ref.	U/Vta	U/Emb
10001901	P142	1	40



Cuaderno de profesor Memo-Notas A4 Evaluación y planificación semanal surtido

Código	Ref.	U/Vta	U/Emb
10001902	P152	1	40



Cuaderno de profesor Programación semanal A4 surtido

Código	Ref.	U/Vta	U/Emb
13805632	P202	1	24



Agenda de profesor G 16 meses M/V 195x285mm

Código	Ref.	U/Vta	U/Emb
82003620	P182	1	40



Cuaderno de profesor Registro de asistencia 195x285mm surtido

Código	Ref.	U/Vta	U/Emb
10001903	P162	1	40



Cuaderno de profesor Diario del aula Organización de centros, programación diaria 225x305mm surtido

Código	Ref.	U/Vta	U/Emb
10001224	C112	1	12



Cuaderno de profesor Triplex
Evaluación, planificación semanal y tutoría
225x310mm surtido

Código	Ref.	U/Vta	U/Emb
10001905	P192	1	24

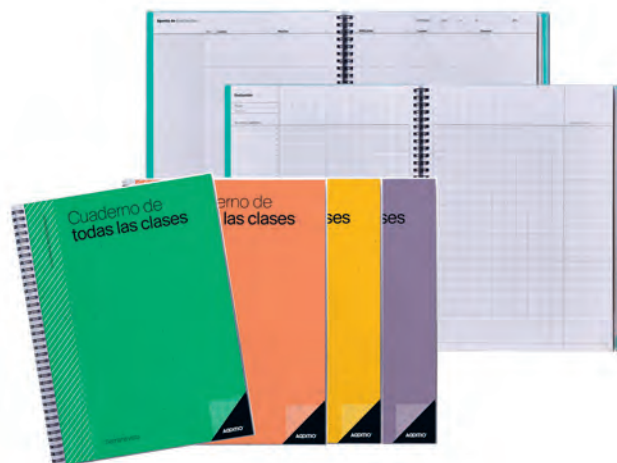

Cuaderno de profesor Todas las clases S/V
Evaluación, programación semanal
225x310mm surtido

Código	Ref.	U/Vta	U/Emb
10001907	P222	1	24



Cuaderno de profesor Todas las clases D/P
Evaluación, programación diaria
170x 240mm surtido

Código	Ref.	U/Vta	U/Emb
10002567	P232	1	24



Agenda del profesor S/V 165x215mm
Evaluación y hojas para anotaciones
en 5 pestañas surtido

Código	Ref.	U/Vta	U/Emb
10001906	P212	1	24



Cuaderno de profesor Carpeta global
Evaluación, programación, tutoría, planificación, agenda,
reuniones y notas
240x320mm surtido

Código	Ref.	U/Vta	U/Emb
10001904	P172	1	24





Bloc de música Basic 240x170mm apaisado

Código	Ref.	Artículo	U/Vta	U/Emb
10007006	M03	3 pentagramas	1	25
10007007	M04	4 pentagramas	1	25
10007008	M05	5 pentagramas	1	25



Bloc de música Basic 6 pentagramas A5 apaisado

Código	Ref.	U/Vta	U/Emb
10001913	M06	1	25

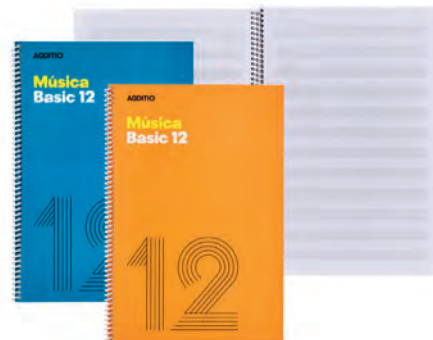

Bloc de música Basic 12 pentagramas F° con espiral

Código	Ref.	U/Vta	U/Emb
10001917	M14	1	15



Bloc de música Combi 240x170mm apaisado alterna hoja pentagramas con hoja para anotaciones y dibujar

Código	Ref.	Artículo	U/Vta	U/Emb
10001911	M45	4 pentagramas	1	25
10001912	M55	5 pentagramas	1	25



Bloc de música Ukelele 240x168mm 4 pentagramas y vademecum de acordes

Código	Ref.	U/Vta	U/Emb
10002699	M24	25	200



Bloc de música Duo 8 pentagramas A4 con cuadrícula inferior para anotaciones

Código	Ref.	U/Vta	U/Emb
10001914	M08	1	15



Bloc de música Mezzo 12 pentagramas A4 con espiral, microperforado, con separador portapartituras páginas finales para anotaciones

Código	Ref.	U/Vta	U/Emb
10001915	M10	1	10



Bloc de música Appunto 12 pentagramas A4 con espiral. Páginas alternas cuadrículadas

Código	Ref.	U/Vta	U/Emb
10001916	M12	1	15



Bloc de música Tab 4 pentagramas A4 con tablatura para guitarra y diagramas de acordes

Código	Ref.	U/Vta	U/Emb
10001919	M22	1	15



Bloc de música Concert 12 pentagramas 20 fundas transparentes portapartituras y páginas para anotaciones, 220x315mm con espiral

Código	Ref.	U/Vta	U/Emb
10001918	M20	1	24



Agenda escolar A5 Planificador musical

Código	Ref.	Idioma	U/Vta	U/Emb
13802203	MP02	Español	1	60
13802204	MP01	Catalán	1	60



Agenda escolar infantil Micro no fechada
Tapa PP con espiral, 160x135mm (0-3 años)

Código	Ref.	U/Vta	U/Emb
13802192	A102	1	48



Agenda escolar infantil Cosmos no fechada
Tapa PP con espiral A5 (3-8 años)

Código	Ref.	U/Vta	U/Emb
13802193	A112-E	1	60



Agenda escolar primaria Planet S/V A5
Tapa PP con espiral (6-12 años)

Código	Ref.	U/Vta	U/Emb
82303663	A122-23	1	60



Agenda escolar secundaria Meridian S/V A5
Tapa PP con espiral (12-16 años)

Código	Ref.	U/Vta	U/Emb
82303664	A132-23	1	60



Agenda escolar Universal tapa PVC espiral, con goma

Código	Ref.	Artículo	U/Vta	U/Emb
82303665	A142-DP-23	D/P (125x170mm)	1	48
82303666	A142-SV-23	S/V (165x215mm)	1	24
82303667	A142-SV-MINI-23	S/V (125x170mm)	1	24



Libreta de Dictados para Primaria A4

Código	Ref.	U/Vta	U/Emb
22201131	D102	1	40



Libreta de Dictados para Secundaria 170x240mm

Código	Ref.	U/Vta	U/Emb
22201132	D122	1	40



Libreta de Redacciones para primaria por ciclos

Código	Ref.	Artículo	U/Vta	U/Emb
22201133	R002	1º ciclo (195x285mm)	1	40
22201134	R102	2º ciclo (170x240mm)	1	40
22201135	R112	3º ciclo (170x240mm)	1	40



Libreta de redacciones para secundaria 285x195mm

Código	Ref.	Artículo	U/Vta	U/Emb
22201136	R122	1º	1	40
22201137	R132	2º	1	40



Agenda escolar Espir Label Color espiral tapa polipropileno con goma Expositor modelos surtidos

Código	Ref	Modelos	Expositor	U/Vta	U/Emb
82303391	632780624	E3 (7,9x12,7cm) S/V apaisado	10 uds	1	1
82303392	633620124	E8 (12x17,1cm) S/V apaisado	10 uds	1	1
82303393	633380124	E8 (12x17,1cm) D/P	8 uds	1	1
82303394	632700824	E9 (9,4x17,1cm) S/V apaisado	10 uds	1	1
82303395	632720024	E10 (15,5x21,2cm) S/V apaisado	10 uds	1	1
82303396	632760424	E10 (15,5x21,2cm) D/P	8 uds	1	1



Agenda escolar Espir Expositor surtido de 26

Código	Ref.	U/Vta	U/Emb
82303397	630900124	1	1

Agenda escolar Secundaria espiral tapa polipropileno Expositores de 10 unidades

Código	Ref.	Formato	U/Vta	U/Emb
82303255	632840124	8° S/V Apais. - 12x16,4cm	1	1
82303274	633640124	8° D/P - 12x16,4cm	1	1
82303293	632800924	4° S/V Apais. - 15,5x21,2cm	1	1
82303307	632870124	4° D/P - 15,5x21,2cm	1	1



Agenda escolar Mini Institut 8° Wire-o 12x16,9cm tapa polipropileno Expositor de 8

Código	Ref.	Formato	U/Vta	U/Emb
82303319	532840224	S/V apaisado	1	1
82303329	532880624	D/P	1	1



Agenda escolar Institut 4° S/V Wire-o tapa polipropileno con goma Expositor de 5

Código	Ref	U/Vta	U/Emb
82303407	532820024	1	1



Agenda escolar Básica espiral 4° S/V apaisado tapa polipropileno 15,5x21,2cm Expositor de 9

Código	Ref.	U/Vta	U/Emb
82303413	532800824	1	1



Agenda escolar C2900
Expositor surtido de 90

Agenda escolar Natural
Expositor surtido

Código	Ref.	U/Vta	U/Emb
82303445	533100124	1	1

Código	Ref.	Expositor	U/Vta	U/Emb
82303433	532780524	10 uds	1	1
82303434	533800124	16 uds	1	1



Agenda escolar C2400 8°
Expositor surtido de 40

Agenda escolar C2450
Expositor surtido de 45

Código	Ref.	U/Vta	U/Emb
82303439	533820124	1	1

Código	Ref.	U/Vta	U/Emb
82303441	532950424	1	1



Agenda escolar C2260 8°
Expositor surtido de 26

Agenda 18 meses
Expositor surtido

Código	Ref.	U/Vta	U/Emb
82303437	533920124	1	1

Código	Ref.	Expositor	U/Vta	U/Emb
82401025	640020124	16 uds	1	1
82401026	636540124	32 uds	1	1



**Agenda escolar Talkual
Expositor surtido de 14**

Código	Ref.	U/Vta	U/Emb
82303455	640040124	1	1



**Agenda escolar Talkual
Expositor surtido de 22**

Código	Ref.	U/Vta	U/Emb
82303456	638840124	1	1



**Agenda escolar Cool espiral tapa extradura
Expositores surtidos**

Código	Ref	Modelos	Expositor	U/Vta	U/Emb
82303211	645760124	8° S/V Apais. - 12x16,2cm	8 uds	1	1
82303221	645780124	8° D/P - 12x16,4cm	8 uds	1	1
82303231	645720124	4° S/V Apais. - 15,5x21,2cm	8 uds	1	1
82303241	645740124	4° D/P - 15,5x21,2cm	8 uds	1	1
82303247	645700124	Surtido	20 uds	1	1



**Agenda Vitae + Tempus + Ikon
Expositor surtido de 14**

Código	Ref.	U/Vta	U/Emb
82401049	540980124	1	1



**Agenda Vitae + Tempus + Ikon
16 meses
Expositor surtido de 17**

Código	Ref.	U/Vta	U/Emb
82401062	540990124	1	1



**Agenda Vitae + Tempus 16 meses
Expositores surtidos**

Código	Ref.	Expositor	U/Vta	U/Emb
82401037	540920124	6 uds	1	1
82401038	540900124	12 uds	1	1



Agenda Infantil no fechada

Código	Ref.	U/Vta	U/Emb
13805424	6316501	1	1



Agenda escolar Magistral 4° S/V apaisado
15,5x21,6cm
Wire-o tapa polipropileno personalizable con goma
Surtido de 6

Código	Ref.	U/Vta	U/Emb
82303461	532730124	1	1



Docente no fechado
Surtido de 5

Código	Ref.	U/Vta	U/Emb
13802218	5345201	1	1



Set de pegatinas + Set notas engomadas Talkual
Surtido de 14

Código	Ref.	U/Vta	U/Emb
82103097	786270121	1	1



Planificadores + Bloc de notas + Set de pegatinas Talkual
Surtido de 20

Código	Ref.	U/Vta	U/Emb
13802172	786230120	1	1



Calendario 16 meses
Surtido de 9

Código	Ref.	U/Vta	U/Emb
82401079	540940124	1	1



Calendario 16 meses
Expositor surtido de pie de 22

Código	Ref.	U/Vta	U/Emb
82401081	541030124	1	1



Carpeta de anillas cartón forrado plastificado F° surtido

Código	Ref.	Descripción	U/Vta	U/Emb
10402816	284FP	4 anillas 25 mm	8	32
10402814	282FP	2 anillas 25 mm	8	32
10402817	384FP	4 anillas 40 mm	8	24
10402815	382FP	2 anillas 40 mm	8	24



Carpeta de anillas F° cartón forrado plastificado mate 4 anillas. Colores pastel.

Código	Ref.	Anillas	Artículo	U/Vta	U/Emb
10402936	283FPEX	25mm	Expositor de 16	1	25
10402937	383FPEX	40mm	Expositor de 12	1	30



Carpebloc A4 4 anillas mixtas 25mm sin recambio 8 colores surtidos

Código	Ref.	U/Vta	U/Emb
10401950	1303SU	1	32



Carpeta cartón forrado plastificado fuele-acordeón con cierre goma 12 bolsas Expositor de 8

Código	Ref.	U/Vta	U/Emb
10301606	0919SU	1	2



Carpeta Clasificadora Forrada F° 12 separadores gomas y solapa. Expositor de 8 unidades

Código	Ref.	U/Vta	U/Emb
10301602	1311	1	2



Carpeta F° de gomas y solapas Mérida, cartón forrado Expositor de 8 unidades

Código	Ref.	U/Vta	U/Emb
10401436	4786SU	1	4

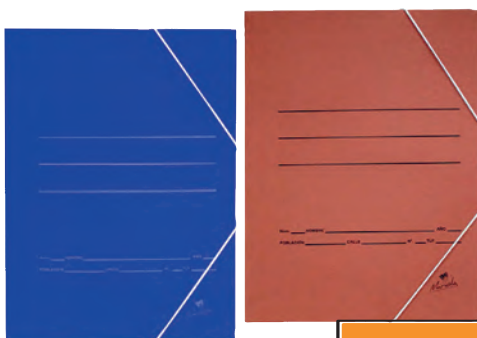

Carpeta de gomas y solapas cartón F°

Las de toda la vida

Código	Ref.	Colores	U/Vta	U/Emb
10404078	1085	Azul	20	120
10417275	1185	Cuero	20	120



Carpeta de gomas y solapas cartón F°

Código	Ref.	Colores	U/Vta	U/Emb
10403522	1085AM	Amarillo	20	120
10403523	1085FU	Fucsia	20	120
10403521	1085RO	Rojo	20	120
10403520	1085VE	Verde	20	120
10401541	1085AZ	Azul	20	120
10403519	1085SU	Surtido	20	120



Carpeta de gomas y solapas F° cartón 5 colores surtidos

Código	Ref.	U/Vta	U/Emb
10403585	1524SU	20	100



Carpeta de gomas y solapas cartón plastificado F°

Código	Ref.	Color	U/Vta	U/Emb
10403513	1523AZ	Azul	20	100
10403512	1523AM	Amarillo	20	100
10403514	1523RO	Rojo	20	100
10403518	1523NE	Negro	20	100
10403515	1523VE	Verde	20	100
10401542	1523SU	Surtido	20	100



Carpeta de dibujo cartón nº12 gofrado A3 con gomas

Código	Ref.	Modelo	Color	U/Vta	U/Emb
10411031	5230AZ	sin solapas	Azul	10	30
10411006	5230CU	sin solapas	Cuero	10	30
10411048	5230NE	sin solapas	Negro	10	30
10411049	5230RO	sin solapas	Rioja/Rojo	10	30
10411050	5230VE	sin solapas	Verde	10	30
10411052	5235AZ	con solapas	Azul	5	20
10411053	5235CU	con solapas	Cuero	5	20
10411054	5235NE	con solapas	Negro	5	20
10411055	5235RO	con solapas	Rioja/Rojo	5	20
10411056	5235VE	con solapas	Verde	5	20



Carpeta de gomas y solapas polipropileno F° 6 colores surtidos

Código	Ref.	U/Vta	U/Emb
10401112	1085PSU	12	120



Carpeta Transferencias forrada Geltex Verde

Código	Ref.	Tamaño	U/Vta	U/Emb
10408026	1675OLVE	A4	1	20
10408000	1685OLVE	F°	1	20



Carpeta de proyectos armada Canarias cartón forrado geltex cierre con gomas

• Lomo 3cm

Código	Ref.	Color	U/Vta	U/Emb
10402166	203FAZ	Azul	1	14
10402167	203FAM	Amarillo	1	14
10402168	203FRO	Rojo	1	14
10402169	203FNE	Negro	1	14
10401042	203FVE	Verde	1	14

• Lomo 5cm

Código	Ref.	Color	U/Vta	U/Emb
10402170	205FAZ	Azul	1	22
10402171	205FAM	Amarillo	1	22
10402172	205FRO	Rojo	1	22
10402173	205FNE	Negro	1	22
10401043	205FVE	Verde	1	22

• Lomo 7cm

Código	Ref.	Color	U/Vta	U/Emb
10402174	207FAZ	Azul	1	16
10402175	207FAM	Amarillo	1	16
10402176	207FRO	Rojo	1	16
10402177	207FNE	Negro	1	16
10401044	207FVE	Verde	1	16

• Lomo 9cm

Código	Ref.	Color	U/Vta	U/Emb
10402178	209FAZ	Azul	1	12
10402179	209FAM	Amarillo	1	12
10402180	209FRO	Rojo	1	12
10402181	209FNE	Negro	1	12
10401045	209FVE	Verde	1	12



Clasificador acordeón Geltex 20 Dptos (1-20) (A-Z)

Código	Ref.	Color	Tamaño	U/Vta	U/Emb
10303060	0918NE	Negro	F°	1	25
10303067	0918RO	Rojo	F°	1	25
10303007	0914RO	Rojo	4°	1	30



Carpeta F° de 4 anillas mixtas 25mm cartón forrado simil cuero

Código	Ref.	U/Vta	U/Emb
10417059	584NF6	1	40



Carpeta de gomas y solapas pastel con frases cartón F° Serie cole N°1 Expositor de 24

Código	Ref.	U/Vta	U/Emb
10403588	4790FR-EX	1	1



Carpeta anillas Cartón gofrado anillas redondas Cuero

Código	Ref.	Anillas	Tamaño	U/Vta	U/Emb
10404034	5182A	2 an. 25mm	F° Apdo	1	45
10404031	0182A	2 an. 40mm	F° Apdo	1	50
10404033	5182N	2 an. 25mm	F°	1	50
10404032	0182N	2 an. 40mm	F°	1	32
10404047	5184N	4 an. 25mm	F°	1	50
10404049	0184N	4 an. 40mm	F°	1	32
10402001	5142A	2 an. 25mm	4° Apdo	1	100
10402004	0142A	2 an. 40mm	4° Apdo	1	80
10402002	5142N	2 an. 25mm	4°	1	80
10402003	0142N	2 an. 40mm	4°	1	40
10402006	5144N	4 an. 25mm	4°	1	80



Carpeta de gomas y solapas F° cartón
Serie Cole N°3
Expositor de 24 surtidos

Código	Ref.	U/Vta	U/Emb
10405036	4793FI-EX	1	1



DEPORTES

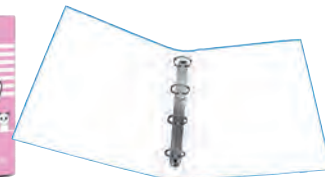

Carpeta de anillas F° Serie Cole
cartón kraft impreso 4 anillas de 25mm
Expositor de 16

Código	Ref.	Modelo	U/Vta	U/Emb
10405050	284FD-EX	Deportes	1	1
10405051	284FI-EX	Friends	1	1

FRIENDS

FRASES



LONDON



Carpebloc Uni A4 4 anillas de 40mm
con recambio 100h 90 cuadrícula 4x4
Expositor de 10

Código	Ref.	Modelo	U/Vta	U/Emb
10405055	2397FP-EX	Frases	1	12
10405057	2397FI-EX	London	1	12
10405061	2397CO-EX	Love	1	12

Carpebloc Uni A4 4 anillas de 40mm
SIN RECAMBIO
Expositor de 12

Código	Ref.	Modelo	U/Vta	U/Emb
10405053	2396FP-EX	Frases	1	32
10405056	2396FI-EX	London	1	32
10405060	2396CO-EX	Love	1	32



LOVE



FLORES

CAMUFLAJE



Carpebloc Cole A4 4 anillas de 40mm
con recambio 100h 90 cuadrícula 4x4
Expositor de 10

Código	Ref.	Modelo	U/Vta	U/Emb
10405053	2397FW-EX	Flores	1	12
10405063	2397CA-EX	Camuflaje	1	12

Carpebloc Cole A4 4 anillas de 40mm
SIN RECAMBIO
Expositor de 12

Código	Ref.	Modelo	U/Vta	U/Emb
10405052	2396FW-EX	Flores	1	32
10405062	2396CA-EX	Camuflaje	1	32



Notas Adhesivas Post-It® 100H

Código	Ref.	Medida	U/Vta	U/Emb
26901000	653	51x38mm	12	288
26901004	654	76x76mm	12	144
26901005	655	127x76mm	12	144
26901001	656	76x51mm	12	192
26901054	657	102x76mm	12	96



Taco notas Post-It® 450H 76x76x45mm

Código	Ref.	Color	U/Vta	U/Emb
26901219	2028-B	Azul pastel	1	12
26901215	2028-G	Verde	1	12
26901217	2028-NB	Azul/Verde neón	1	12
26901216	2028-NP	Rosa neón	1	12
26901214	2028-P	Rosa pastel	1	12



Taco de notas 63,5x76mm 90 hojas
Pack Autobús 8 tacos de colores surtidos

Código	Ref.	U/Vta	U/Emb
26901390	7100254025	1	6



Notas adhesivas Post-It® 100H
Z Notes 76x76mm

Código	Ref.	U/Vta	U/Emb
26901003	R-330	12	144



Banderitas adhesivas Post-It® (1")

Código	Ref.	Color	U/Vta	U/Emb
26901012	680-1	Rojo	12	36
26901019	680-2	Azul	12	36
26901022	680-21	Rosa	12	36
26901011	680-3	Verde	12	36
26901018	680-4	Naranja	12	36
26901009	680-5	Amarillo	12	36
26901013	680-8	Violeta	12	36



Banderitas adhesivas Post-It® (1/2")
Pack de 4 (Azul-Amarillo-Rojo-Verde)

Código	Ref.	U/Vta	U/Emb
26901260	683-4	6	24



Corrector cinta papel 18x25 mm

Código	Ref.	U/Vta	U/Emb
15103001	658-HD	1	48



Rollos cinta Scotch® Crystal 33m x 19mm

Código	Ref.	U/Vta	U/Emb
11901064	600/1933	12	24



Rollos cinta Scotch® 33m x 19mm

Código	Ref.	U/Vta	U/Emb
11901286	508/1933 AE	8	160



Rollos cinta Scotch® transparente
33m x 19mm

Código	Ref.	U/Vta	U/Emb
11901029	550/1933 EIC	8	8



Cinta Scotch® dos caras con mini portarrollos

Código	Ref.	Artículo	U/Vta	U/Emb
11901076	136DB36	12mm x 6,3m	12	36
11901009	4496G-1915-P	19mm x 1,5m	6	24



Pegamento Spray Mount 400 ml

Código	Ref.	U/Vta	U/Emb
23104046	3M Display Mount	1	12
23104003	3M Photo Mount	1	12
23104004	3M Spray Mount	1	12
23101050	3M ReMount	1	12



BORRA CON AGUA
ROTULADOR PERMANENTE

Pizarra blanca adhesiva en rollo
para escribir con rotulador

Código	Ref.	Artículo	U/Vta	U/Emb
23801665	7100197625	60,9x91,4 cm	6	12
23801724	7100197624	91,4x121,9 cm	6	12
23801804	7100198315	121,9x182,9 cm	6	12
23801805	7100198316	121,9x243,8 cm	6	12



Bloc Notebook 4 microperforado tapa dura grafito 160 hojas

Código	Ref.	Artículo	Tamaño	U/Vta	U/Emb
10013017	MR2107	Cuadric. 5x5	A4	5	5
10013018	MR2108	Liso	A4	5	5
10013037	MR2135	Horizontal	A4	5	5
10013002	MR2120	Cuadric. 5x5	A5	5	5
10013173	MR2121	Liso	A5	5	5
10013682	MR2140	Horizontal	A5	5	5

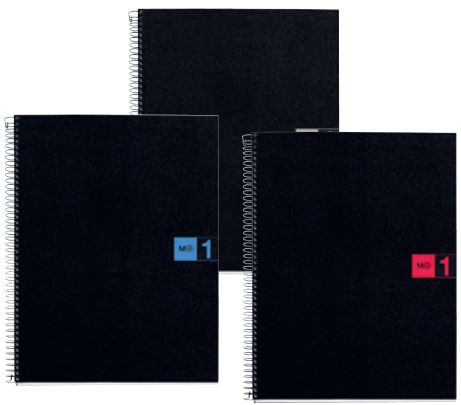

Bloc Notebook 1 microperforado tapa PP A4 80 hojas, cuadrícula 5x5

Código	Ref.	Color	U/Vta	U/Emb
10013607	MR2471	Azul	5	5
10013608	MR2472	Rojo	5	5
10013606	MR2473	Gris	5	5
10013609	MR2474	Verde	5	5
10013610	MR2475	Fucsia	5	5
10013611	MR2476	Turquesa	5	5
10013563	MR2477	Violeta	5	5
10013661	MR2478	Naranja	5	5



Bloc Basic negro microperforado tapa PP cuadrícula 5x5

• Notebook 4 - 140h

Código	Ref.	Artículo	U/Vta	U/Emb
10013742	MR47138	A4	5	5
10013726	MR47142	A5	5	5

• Notebook 10 - 200h

Código	Ref.	Artículo	U/Vta	U/Emb
10001998	MR47009	A4	5	5
10001999	MR47044	A5	5	5



Bloc Notebook 8 microperforado tapa PP 200 hojas 70g, cuadrícula 5x5

Código	Ref.	Color	Tamaño	U/Vta	U/Emb
10018038	MR42002	Rojo	A4	5	5
10018039	MR42004	Azul	A4	5	5
10013564	MR42006	Negro	A4	5	5
10003243	MR42238	Gris	A4	5	5
10003244	MR42239	Verde	A4	5	5
10013754	MR42003	Rojo	A5	5	5
10013755	MR42005	Azul	A5	5	5
10013565	MR42007	Negro	A5	5	5



Bloc Notebook 6 microperforado tapa PP 150 hojas, cuadrícula 5x5

Código	Ref.	Color	Tamaño	U/Vta	U/Emb
10013014	MR2824	Negro	A4	5	5
10013685	MR2825	Rojo	A4	5	5
10013684	MR2826	Azul	A4	5	5
10013001	MR2827	Negro	A5	5	5
70419175	MR2828	Rojo	A5	5	5
70419176	MR2829	Azul	A5	5	5



Bloc Notebook 4 Reporter microperforado tapa dura 120 hojas 70g, cuadrícula 5x5

Código	Ref.	Artículo	U/Vta	U/Emb
10003241	MR44388	A4	5	5
10003240	MR44387	A5	5	5
10003242	MR44751	A6	5	5



Recambio A4 100 hojas de 70g, 4 taladros, cuadrícula 5x5

Código	Ref.	Color	U/Vta	U/Emb
25401009	MR7421	Azul	1	40
25401099	MR7422	Rojo	1	40
25401100	MR7423	Gris	1	40
25401101	MR7424	Verde	1	40
25401102	MR7425	Fucsia	1	40
25401119	MR7426	Turquesa	1	40
25401121	MR7427	Violeta	1	40
25401120	MR7428	Naranja	1	40



Recambio Notebook A4, cuadrícula 5x5

Código	Ref.	Artículo	U/Vta	U/Emb
15002031	MR7429	4 col. - 100h	1	40
10018040	MR7439	6 col. - 120h	1	40
10018041	MR7440	8 col. - 200h	1	40



Carpebloc Emotions A4 cartón forrado 4 anillas mixtas de 35mm recambio de 100h 90g

Código	Ref.	Color	U/Vta	U/Emb
10402544	MR14682	Marino	1	3
10402545	MR14683	Cielo	1	3
10402547	MR14685	Rojo	1	3
10402548	MR14686	Turquesa	1	3
10402549	MR14687	Rosa	1	3
10403791	MR15020	Menta	1	3
10403792	MR15021	Coral	1	3
10403793	MR15022	Púrpura	1	3
10403794	MR15023	Lavanda	1	3
10403795	MR15024	Gris	1	3



Bloc Emotions Notebook 1 A4 microperforado tapa dura, 80hojas 90g, cuadrícula 5x5

Código	Ref.	Color	U/Vta	U/Emb
10001765	MR46047	Azul cielo	5	5
10001773	MR46055	Lavanda	5	5
10001764	MR46046	Marino	5	5
10001768	MR46050	Menta	5	5
10001763	MR46045	Negro	5	5
10001771	MR46053	Rojo	5	5
10001774	MR46056	Rosa	5	5
10001766	MR46048	Turquesa	5	5
10001767	MR46049	Verde	5	5
10001972	MR46075	Formentera	5	5
10001973	MR46076	Lima	5	5
10002934	MR46624	Púrpura	5	5
10002935	MR46625	Coral	5	5
10002936	MR46626	Gris	5	5



Bloc Emotions Notebook 1 A4 tapa PP, microperforado 80hojas de 90g Cuadrícula 5x5

Código	Ref.	Color	U/Vta	U/Emb
10001776	46058	Azul cielo	5	5
10001775	46057	Marino	5	5
10001778	46060	Rojo	5	5
10001780	46062	Rosa	5	5
10001779	46061	Turquesa	5	5



Bloc Emotions Notebook 5 tapa dura cartón, microperforado 120 hojas de 90g Cuadrícula 5x5

Código	Ref.	Tamaño	Color	U/Vta	U/Emb
10001782	46064	A4	Azul cielo	5	5
10001781	46063	A4	Marino	5	5
10001784	46066	A4	Rojo	5	5
10001786	46068	A4	Rosa	5	5
10001785	46067	A4	Turquesa	5	5
10001975	46078	A4	Lima	5	5
10001974	46077	A4	Lavanda	5	5
10001982	46089	A5	Marino	5	5
10001983	46090	A5	Rojo	5	5
10001987	46094	A5	Lima	5	5
10001984	46091	A5	Azul cielo	5	5
10001986	46093	A5	Rosa	5	5
10001985	46092	A5	Lavanda	5	5



Bloc Emotions Notebook 5 A4 tapa PP, microperforado 120 hojas de 90g Cuadrícula 5x5

Código	Ref.	Tamaño	Color	U/Vta	U/Emb
10001672	46070	A4	Azul cielo	5	5
10001671	46069	A4	Marino	5	5
10001674	46072	A4	Rojo	5	5
10001676	46074	A4	Rosa	5	5
10001675	46073	A4	Turquesa	5	5
10001673	46071	A4	Verde	5	5
10001977	46080	A4	Lima	5	5
10001976	46079	A4	Lavanda	5	5
10001988	46101	A5	Marino	5	5
10001989	46102	A5	Rojo	5	5
10001993	46106	A5	Lima	5	5
10001990	46103	A5	Azul cielo	5	5
10001992	46105	A5	Rosa	5	5
10001991	46104	A5	Lavanda	5	5



Bloc Emotions Notebook 8 tapa PP, microperforado 160hojas de 90g Cuadrícula 5x5

Código	Ref.	Tamaño	Color	U/Vta	U/Emb
10001979	46082	A4	Lima	5	5
10001980	46083	A4	Azul cielo	5	5
10001981	46084	A4	Rosa	5	5
10001995	46108	A5	Lima	5	5
10001996	46109	A5	Azul cielo	5	5
10001997	46110	A5	Rosa	5	5



Bloc Emotions Notebook 1 A5 microperforado tapa dura, 80hojas 90g, cuadrícula 5x5

Código	Ref.	Color	U/Vta	U/Emb
10002939	MR46675	Lavanda	5	5
10002942	MR46678	Marino	5	5
10002938	MR46674	Menta	5	5
10002945	MR46681	Rojo	5	5
10002940	MR46676	Rosa	5	5
10002943	MR46679	Turquesa	5	5
10002947	MR46683	Formentera	5	5
10002948	MR46684	Lima	5	5
10002944	MR46680	Púrpura	5	5
10002946	MR46682	Coral	5	5
10002941	MR46677	Gris	5	5
10002937	MR46673	Azul cielo	5	5



Carpebloc Tie Dye A4 cartón forrado 4 anillas mixtas de 35mm recambio 100h 90g

Código	Ref.	Color	U/Vta	U/Emb
10403583	MR14865	Azul	1	1
10403584	MR14864	Rosa	1	1



Bloc Notebook 1 80h 90g Tapa dura microperforado

• Cuadrícula 5x5

Código	Ref.	Tamaño	Color	U/Vta	U/Emb
10002709	MR46581	A4	Azul oceano	5	5
10002711	MR46578	A4	Rosa arena	5	5
10002713	MR46579	A4	Verde aqua	5	5
10002715	MR46580	A4	Gris grafito	5	5
10002717	MR46589	A5	Azul oceano	5	5
10002719	MR46588	A5	Rosa arena	5	5

• Horizontal 7mm

Código	Ref.	Tamaño	Color	U/Vta	U/Emb
10002710	MR49975	A4	Azul oceano	5	5
10002712	MR49966	A4	Rosa arena	5	5
10002714	MR49967	A4	Verde aqua	5	5
10002716	MR49974	A4	Gris grafito	5	5
10002718	MR49993	A5	Azul oceano	5	5
10002720	MR49992	A5	Rosa arena	5	5



Bloc Emotions Notebook 1ECO A4 80h 80gr microperforado, cuadrícula 5x5

Código	Ref.	Color	U/Vta	U/Emb
10002516	MR6090	Ecolavanda	5	5
10002517	MR6091	Ecoverde	5	5
10002518	MR6092	Ecoazul	5	5
10002519	MR6093	Ecorosa	5	5



Bloc Notebook 1 tapa dura cartón reciclado 80h 80g



• Cuadrícula 5x5

Código	Ref.	Tamaño	Modelo	U/Vta	U/Emb
10002604	MR6105	A4	Ecobutterfly	5	5
10002603	MR6104	A4	Ecomaps	5	5
10002949	MR6128	A4	Ecoflowers	5	5
10002950	MR6129	A4	Ecomystic	5	5
10003245	MR6154	A4	Ecoconfetti	5	5
10002706	MR6107	A5	Ecobutterfly	5	5
10002707	MR6106	A5	Ecomaps	5	5
10002951	MR6130	A5	Ecoflowers	5	5
10002952	MR6131	A5	Ecomystic	5	5
10003246	MR6156	A5	Ecoconfetti	5	5

• Horizontal 7mm

Código	Ref.	Tamaño	Modelo	U/Vta	U/Emb
10002704	MR6109	A4	Ecobutterfly	5	5
10002705	MR6108	A4	Ecomaps	5	5
62102838	MR6111	A5	Ecobutterfly	5	5
10002708	MR6110	A5	Ecomaps	5	5



Cinta adhesiva doble cara Duo

Código	Ref.	Artículo	U/Vta	U/Emb
11901358	75600000	10x15	10	60
11901359	75600100	10x30	10	60
11901360	75600200	15x15	8	48
11901361	75600400	15x30	8	48
11901362	75600500	20x15	6	36
11901363	75600900	20x30	6	36



Forro ajustable fijo PVC transparente 130µ

Código	Ref.	Medida	U/Vta	U/Emb
11801208	01009100	280x530	100	100
11801209	01009200	290x530	100	100
11801210	01009300	300x530	100	100



Forro ajustable fijo transparente 130µ Pack de 5

Código	Ref.	Artículo	U/Vta	U/Emb
11801142	01009600	PVC 29 x 53 cm	40	40
11801143	01009700	PVC 30 x 53 cm	40	40
11801029	01014500	PP 30 x 52 cm	50	50



Cinta de embalaje Fixo Polipropileno Hotmelt 66m x 48mm

Código	Ref.	Artículo	U/Vta	U/Emb
11901265	48066200	Transparente	6	36
11901266	48066240	Marrón	6	36

Cinta de embalaje Fixo Extra fuerte polipropileno caucho 132m x 48mm

Código	Ref.	Color	U/Vta	U/Emb
11901482	50132200	Transparente	36	36
11901483	50132240	Marrón	36	36



Rollos Fijo

Código	Ref.	Artículo	U/Vta	U/Emb
11901004	75005100	66m x 12mm	12	144
11901014	75005300	66m x 19mm	8	96
11901035	75003000	33m x 12mm	24	288
11901036	75003300	33m x 19mm	20	240



Rollo Fijo color 33m x 19mm

Código	Ref.	Artículo	U/Vta	U/Emb
11901268	75088120	Verde	16	256
11901269	75088230	Azul	16	256
11901270	75088351	Rojos	16	256
11901271	75088460	Amarillo	16	256
11901272	75088510	Negro	16	256
11901273	75088570	Blanco	16	256



Cinta de embalaje Fixo papel Kraft caucho marrón 50m x 50mm

Código	Ref.	U/Vta	U/Emb
11901449	50066449	6	36



Barra de pegamento mágico morado

Código	Ref.	Artículo	U/Vta	U/Emb
23102077	20535	20g	24	96
23101352	20635	40g	12	48



Compás micrométrico con minas

Código	Ref.	Color	U/Vta	U/Emb
16301201	00008310	Negro	1	100
16301202	00008320	Verde	1	100
16301203	00008351	Rojos	1	100



Compás Micrométrico ajuste rápido

Código	Ref.	Artículo	U/Vta	U/Emb
16301200	00008530	Ajuste rápido	1	100
16301204	00008430	Con adaptador y minas	1	100
16301205	00008230	Articulado, pata ancha	1	100



Carpeta Fundas Tarifario - PP rígido Poliuro Fº Negro

Código	Ref.	Artículo	U/Vta	U/Emb
15301052	39708010	80 F.	1	8
15301053	39706010	60 F.	1	12
15301085	39704010	40 F.	1	20
15301086	39702010	20 F.	1	32



Carpeta fundas espiral PP rígido maxiplas gloss Expositor de 16

Código	Ref.	U/Vta	U/Emb
15301969	00398000	1	1



Carpeta Fundas Tarifario - PP Flexible Poliplus Opaco Fº Negro

Código	Ref.	Artículo	U/Vta	U/Emb
15301050	01430010	10 F.	1	48
15301051	01470010	30 F.	1	32
15301075	01450010	20 F.	1	32
15301076	01440010	40 F.	1	20
15301078	01460010	50 F.	1	20



Goma EVA en hojas
Paquete de 10

• 40 x 60cm

Código	Ref.	Color	U/Vta	U/Emb
25208030	00036110	Negro	1	24
25208048	00036121	Verde Claro	1	24
25208046	00036122	Verde	1	24
25208044	00036130	Azul	1	24
25208052	00036132	Azul Oscuro	1	24
25208853	00036133	Azul Cielo	1	24
25208055	00036135	Malva	1	24
25208051	00036140	Marrón	1	24
25208056	00036143	Carne	1	24
25208045	00036151	Rojo	1	24
25208050	00036152	Naranja	1	24
25208049	00036153	Rosa	1	24
25208852	00036154	Fucsia	1	24
25208047	00036160	Amarillo	1	24
25208058	00036170	Blanco	1	24
25208043	00036171	Gris	1	24

• 20 x 30cm

Código	Ref.	Color	U/Vta	U/Emb
25208854	00036410	Negro	1	96
25208855	00036421	Verde claro	1	96
25208856	00036422	Verde oscuro	1	96
25208857	00036430	Azul	1	96
25208858	00036435	Violeta	1	96
25208859	00036443	Beige	1	96
25208860	00036451	Rojo	1	96
25208861	00036454	Fucsia	1	96
25208862	00036460	Amarillo	1	96
25208863	00036470	Blanco	1	96
25208864	00036471	Gris	1	96



Goma EVA en hojas 40 x 60cm
Paquete de 5

• Adhesiva

Código	Ref.	Color	U/Vta	U/Emb
25208185	00037510	Negro	1	20
25208180	00037521	Verde	1	20
25208183	00037530	Azul	1	20
25208181	00037543	Beige	1	20
25208182	00037551	Rojo	1	20
25208178	00037560	Amarillo	1	20
25208177	00037570	Blanco	1	20
25208866	00037699	Bolsa de 7 surtido	1	20

• Toalla

Código	Ref.	Color	U/Vta	U/Emb
25208323	00036510	Negro	1	20
25208320	00036521	Verde Claro	1	20
25208315	00036522	Verde Oscuro	1	20
25208319	00036530	Azul	1	20
25208322	00036540	Marrón	1	20
25208317	00036551	Rojo	1	20
25208314	00036552	Naranja	1	20
25208316	00036553	Rosa	1	20
25208313	00036560	Amarillo	1	20
25208312	00036570	Blanco	1	20
25208865	00036699	Bolsa 10 surtido	1	10



Bolsa disfraz 65 x 90cm

Código	Ref.	Color	U/Vta	U/Emb
11401221	00072060	Amarilla	25	250
11401228	00072031	Azul claro	25	250
11401219	00072032	Azul oscuro	25	250
11401217	00072070	Blanca	25	250
11401229	00072040	Marrón	25	250
11401227	00072052	Naranja	25	250
11401230	00072010	Negro	25	250
11401223	00072065	Oro	25	250
11401224	00072075	Plata	25	250
11401218	00072051	Roja	25	250
11401222	00072053	Rosa	25	250
11401225	00072021	Verde claro	25	250
11401220	00072022	Verde oscuro	25	250
11401226	00072035	Violeta	25	250
12401212	00072071	Gris	25	250

Bolsa disfraz 56 x 70cm

Código	Ref.	Color	U/Vta	U/Emb
12401116	00072210	Negro	25	250
12401122	00072221	Verde claro	25	250
12401123	00072222	Verde oscuro	25	250
12401125	00072231	Azul claro	25	250
12401136	00072232	Azul oscuro	25	250
12401156	00072240	Marrón	25	250
12401157	00072251	Rojo	25	250
12401158	00072252	Naranja	25	250
12401159	00072253	Rosa	25	250
12401165	00072260	Amarillo	25	250
12401184	00072270	Blanco	25	250



Bolsa disfraz impresa 56x70 cm

Código	Ref.	Color	U/Vta	U/Emb
12401199	00072301	Amarillo/Negro	25	400
12401205	00072302	Blanco/Negro	25	400
12401206	00072303	Topos Rojo	25	400
12401207	00072304	Blanco/Rojo	25	400
12401208	00072305	Topos Negros	25	400
12401209	00072306	Naranja/Negro	25	400
12401210	00072307	Amarillo/Marrón	25	400
12401211	00072309	Ondas Verde	25	400

Bolsa disfraz impresa 65x90 cm

Código	Ref.	Color	U/Vta	U/Emb
12401054	00072101	Amarillo/Negro	5	35
12401056	00072102	Blanco/Negro	5	35
12401067	00072103	Topos Rojo	5	35
12401077	00072104	Blanco/Rojo	5	35
12401096	00072105	Topos Negros	5	35
12401100	00072106	Naranja/Negro	5	35
12401103	00072107	Amarillo/Marrón	5	35
12401111	00072109	Ondas Verde	5	35



Carpeta Escolar - F° PVC 4 anillas 25mm.
7 colores

Código	Ref.	Artículo	U/Vta	U/Emb
10417340	00016325	Exp. 12	1	1
10417357	08132599	Surtido	1	14



Carpeta Escolar 4° PVC 4 anillas 20mm.
6 colores

Código	Ref.	Artículo	U/Vta	U/Emb
10402378	00016225	Exp. 10	1	1
10402380	08032599	Surtido	1	24



Bloc Centauro tapa normal 80h 90g
Colores surtidos

Código	Ref.	Tamaño	Artículo	U/Vta	U/Emb
10002485	88450299	4°	Cuadric. 4x4	10	30
10002484	88450298	4°	Horizontal	10	30
10002481	88450295	4°	Liso	10	30
10002482	88450296	4°	Pauta 2,5	10	30
10002483	88450297	4°	Pauta 3,5	10	30
10002448	88440299	F°	Cuadric. 4x4	10	30
10002447	88440298	F°	Horizontal	10	30
10002444	88440295	F°	Liso	10	30
10002443	88440294	F°	Milimetrado	10	30
10002445	88440296	F°	Pauta 2,5	10	30
10002446	88440297	F°	Pauta 3,5	10	30



Carpebloc Centauro A4 cartón forrado 4 anillas mixtas
recambio 120h cuadrícula 4x4

Código	Ref.	U/Vta	U/Emb
10403254	88102399	1	1



Bloc de dibujo Guerrero F° prolongado 20h 120g
2 taladros

Código	Ref.	Artículo	U/Vta	U/Emb
10002510	37002299	Liso	18	40
10002514	37002499	Recuadro	10	40



Bloc de dibujo Papyrus F° prolongado 20h 160g
2 taladros

Código	Ref.	Artículo	U/Vta	U/Emb
10002509	37002298	Liso	10	40
10002513	37002498	Recuadro	15	40



Bloc de dibujo Senator 20h 150g

Código	Ref.	Tamaño	Artículo	U/Vta	U/Emb
10002515	37012110	A3	Liso	10	40
10002507	37002110	F° prol.	Liso	16	40
10002508	37002210	F° prol.	Liso, 2 taladros	10	40
10002511	37002310	F° prol.	Recuadro	10	40
10002512	37002410	F° prol.	Recuadro, 2 taladros	16	40



Recambio Papyrus Unicolor 5 A4 100h 90g
4 taladros cuadrícula 5x5

Código	Ref.	Artículo	U/Vta	U/Emb
25401553	53392398	Colores pastel	24	24
25401554	53392399	Colores vivos	24	24



Recambio Papyrus Unicolor 1 A4 100h 90g
4 taladros, cuadrícula 5x5

Código	Ref.	Color	U/Vta	U/Emb
25401547	53392221	Lima	24	24
25401548	53392226	Mint	24	24
25401551	53392252	Naranja	24	24
25401550	53392251	Rojo	24	24
25401552	53392253	Rosa claro	24	24
25401549	53392236	Turquesa	24	24
25401556	53392699	Surtido	24	24



Recambio Papyrus Unicolor 10 A4 160h 90g
4 taladros cuadrícula 5x5

Código	Ref.	U/Vta	U/Emb
25401555	53392499	15	15



Recambio Papyrus Uniclassic 100h 90g 4 taladros con margen

Código	Ref.	Tamaño	Artículo	U/Vta	U/Emb
25401545	53391800	A4	Cuadric. 3x3	24	24
25401539	53391000	A4	Cuadric. 4x4	24	24
25401541	53391400	A4	Horizontal	24	24
25401540	53391300	A4	Liso	24	24
25401544	53391700	A4	Milimetrado	24	24
25401543	53391600	A4	Pausa 2,5	24	24
25401542	53391500	A4	Pausa 3,5	24	24
25401546	53391900	A5	Cuadric. 4x4	48	48



Bloc Papyrus tapa extradura contracolada 80h 90g
Colores surtidos

Código	Ref.	Tamaño	Artículo	U/Vta	U/Emb
10002490	88451099	4°	Cuadric. 4x4	5	25
10002489	88451098	4°	Horizontal	5	25
10002486	88451095	4°	Liso	5	25
10002487	88451096	4°	Pauta 2,5	5	25
10002488	88451097	4°	Pauta 3,5	5	25
10002454	88441099	F°	Cuadric. 4x4	5	25
10002453	88441098	F°	Horizontal	5	25
10002450	88441095	F°	Liso	5	25
10002449	88441094	F°	Milimetrado	5	25
10002451	88441096	F°	Pauta 2,5	5	25
10002452	88441097	F°	Pauta 3,5	5	25



Bloc Papyrus tapa normal 80h 90g
Colores surtidos

Código	Ref.	Tamaño	Artículo	U/Vta	U/Emb
10002475	88450099	4°	Cuadric. 4x4	10	30
10002474	88450098	4°	Horizontal	10	30
10002471	88450095	4°	Liso	10	30
10002472	88450096	4°	Pauta 2,5	10	30
10002473	88450097	4°	Pauta 3,5	10	30
10002436	88440099	F°	Cuadric. 4x4	10	30
10002435	88440098	F°	Horizontal	10	30
10002432	88440095	F°	Liso	10	30
10002431	88440094	F°	Milimetrado	10	30
10002433	88440096	F°	Pauta 2,5	10	30
10002434	88440097	F°	Pauta 3,5	10	30



Bloc Papyrus Uniclas tapa polipropileno 80h 90g
Colores surtidos

Código	Ref.	Tamaño	Artículo	U/Vta	U/Emb
10002495	88452099	4°	Cuadric. 4x4	5	25
10002494	88452098	4°	Horizontal	5	25
10002491	88452095	4°	Liso	5	25
10002492	88452096	4°	Pauta 2,5	5	25
10002493	88452097	4°	Pauta 3,5	5	25
10002461	88442099	F°	Cuadric. 4x4	5	25
10002455	88442093	F°	Cuadric. 5x5	5	25
10002460	88442098	F°	Horizontal	5	25
10002457	88442095	F°	Liso	5	25
10002456	88442094	F°	Milimetrado	5	25
10002458	88442096	F°	Pauta 2,5	5	25
10002459	88442097	F°	Pauta 3,5	5	25



Bloc Papyrus Uniclas tapa extradura 80h 90g
Colores surtidos

Código	Ref.	Tamaño	Artículo	U/Vta	U/Emb
10002502	88453099	4°	Cuadric. 4x4	5	25
10002501	88453098	4°	Horizontal	5	25
10002499	88453095	4°	Liso	5	25
10002500	88453097	4°	Pauta 3,5	5	25
10002470	88443099	F°	Cuadric. 4x4	5	25
10002465	88443093	F°	Cuadric. 5x5	5	25
10002469	88443098	F°	Horizontal	5	25
10002467	88443095	F°	Liso	5	25
10002466	88443094	F°	Milimetrado	5	25
10002468	88443097	F°	Pauta 3,5	5	25



Bloc Papyrus Uniclas tapa extradura A4+ 90g
cuadrícula 5x5. Colores surtidos

Código	Ref.	Artículo	U/Vta	U/Emb
10002506	88463199	120 hojas	5	25
10002505	88463099	80 hojas	5	25



Bloc Papyrus Uniclas 1 tapa polipropileno A4+ 90g
cuadrícula 5x5. Colores surtidos

Código	Ref.	Artículo	U/Vta	U/Emb
10002504	88462193	120 hojas	5	25
10002503	88462093	80 hojas	5	25



Libreta Papyrus tapa blanda 48h 90g cuadrícula 4x4
Colores surtidos

Código	Ref.	Tamaño	U/Vta	U/Emb
20902057	88421099	A4	10	10
20902058	88431099	A5+	10	10



Libreta Papyrus tapa polipropileno 48h 90g
Colores surtidos

Código	Ref.	Tamaño	Artículo	U/Vta	U/Emb
20902084	88421799	A4	Cuadric. 4x4	10	10
20902093	88421899	A4	Cuadric. 5x5	10	10
20902102	88421999	A4	Horizontal	10	10
20902075	88421699	A4	Liso	10	10
20902120	88422199	A4	Pauta 2,5	10	10
20902111	88422099	A4	Pauta 3,5	10	10
20902138	88431799	A5+	Cuadric. 4x4	10	10
20902147	88431999	A5+	Horizontal	10	10
20902129	88431699	A5+	Liso	10	10
20902165	88432199	A5+	Pauta 2,5	10	10
20902156	88432099	A5+	Pauta 3,5	10	10



Libreta Papyrus tapa gofrada 48h 90g
Colores surtidos

Código	Ref.	Tamaño	Artículo	U/Vta	U/Emb
20902047	88420599	A4	Cuadric. 4x4	10	10
20902048	88420699	A4	Horizontal	10	10
20902046	88420499	A4	Liso	10	10
20902051	88420999	A4	Milimetrado	10	10
20902050	88420899	A4	Pauta 2,5	10	10
20902049	88420799	A4	Pauta 3,5	10	10
20902052	88430599	A5+	Cuadric. 4x4	10	10
20902053	88430699	A5+	Horizontal	10	10
20902056	88430999	A5+	Milimetrado	10	10
20902055	88430899	A5+	Pauta 2,5	10	10
20902054	88430799	A5+	Pauta 3,5	10	10



Bloc Guerrero tapa normal 80h 90g
Colores surtidos

Código	Ref.	Tamaño	Artículo	U/Vta	U/Emb
10002480	88450199	4º	Cuadric. 4x4	10	30
10002479	88450198	4º	Horizontal	10	30
10002476	88450195	4º	Liso	10	30
10002477	88450196	4º	Pauta 2,5	10	30
10002478	88450197	4º	Pauta 3,5	10	30
10002442	88440199	Fº	Cuadric. 4x4	10	30
10002441	88440198	Fº	Horizontal	10	30
10002438	88440195	Fº	Liso	10	30
10002437	88440194	Fº	Milimetrado	10	30
10002439	88440196	Fº	Pauta 2,5	10	30
10002440	88440197	Fº	Pauta 3,5	10	30



Libreta Guerrero tapa blanda 48h 90g. Colores surtidos

Código	Ref.	Tamaño	Artículo	U/Vta	U/Emb
20902060	88421299	A4	Cuadric. 4x4	10	10
20902061	88421399	A4	Horizontal	10	10
20902059	88421199	A4	Liso	10	10
20902063	88421599	A4	Pauta 2,5	10	10
20902062	88421499	A4	Pauta 3,5	10	10
20902064	88431299	A5+	Cuadric. 4x4	10	10
20902065	88431399	A5+	Horizontal	10	10
20902132	88431599	A5+	Pauta 2,5	10	10
20902066	88431499	A5+	Pauta 3,5	10	10



Libreta Guerrero tapa polipropileno 48h 90g.
Colores surtidos

Código	Ref.	Tamaño	Artículo	U/Vta	U/Emb
20902125	88422299	A4	Cuadric. 4x4	10	40
20902126	88422399	A4	Cuadric. 5x5	10	40
20902128	88422599	A4	Horizontal	10	40
20902127	88422499	A4	Liso	10	40
20902131	88422799	A4	Pauta 2,5	10	40
20902130	88422699	A4	Pauta 3,5	10	40
20902133	88432299	A5+	Cuadric. 4x4	10	40
20902135	88432599	A5+	Horizontal	10	40
20902134	88432499	A5+	Liso	10	40
20902137	88432799	A5+	Pauta 2,5	10	40
20902136	88432699	A5+	Pauta 3,5	10	40

Gama UNICLASE



Carpebloc Uniclase A4 cartón forrado
4 anillas mixtas 35mm con recambio de 100 hojas

Código	Ref.	Color	U/Vta	U/Emb
10403684	88102721	Verde claro	2	2
10403685	88102735	Violeta	2	2
10403686	88102752	Naranja	2	2
10403687	88102753	Rosa	2	2
10403914	88102899	Surtido	8	8

Carpeta clasificadora Uniclase Fº
cartón forrado con gomas y solapas,
12 separadores. Colores surtidos

Código	Ref.	U/Vta	U/Emb
10301774	82213399	8	8

Carpeta gomas y solapas Uniclase Fº cartón forrado
Colores surtidos

Código	Ref.	U/Vta	U/Emb
10402657	01222899	8	8



Carpeta de anillas Uniclase A4
cartón forrado 4 anillas mixtas
Colores surtidos

Código	Ref.	Anillas	U/Vta	U/Emb
10403682	07321899	25mm	8	8
10403683	07322099	40mm	8	8



Agenda escolar Centauro espiral
tapa extradura con goma
Pack de 5 surtido

Código	Ref.	Tamaño	U/Vta	U/Emb
82303583	75140899	A5 S/V	1	1
82303584	75171599	A6 D/P	1	1



Gama
I LIKE



Bloc Like 2 A4 tapa polipropileno 80h 90g
Colores surtidos

Código	Ref.	Artículo	U/Vta	U/Emb
10003125	88500299	Cuadr. 4x4	12	12
10003124	88500298	Horizontal	12	12



Clasificador acordeón Like 2 Fº PP semirrígido opaco
13 dptos. Bolsillo y goma

Código	Ref.	Color	U/Vta	U/Emb
10301814	2963410	Negro	2	2
10301815	2963421	Verde	2	2
10301816	2963426	Mint	2	2
10301817	2963430	Azul	2	2
10301818	2963433	Azul claro	2	2
10301819	2963435	Morado	2	2
10301820	2963436	Turquesa	2	2
10301821	2963453	Rosa claro	2	2
10301822	2963454	Fucsia	2	2
10301823	2963455	Mandarina	2	2
10301824	2963469	Lavanda	2	2
10301825	2963484	Coral	2	2



Carpeta de gomas y solapas Like 2 Fº Maxi polipropileno

Código	Ref.	Color	U/Vta	U/Emb
10403847	4800810	Negro	2	2
10403848	4800821	Verde	2	2
10403849	4800826	Mint	2	2
10403850	4800830	Azul	2	2
10403851	4800833	Azul claro	2	2
10403852	4800835	Morado	2	2
10403853	4800836	Turquesa	2	2
10403854	4800853	Rosa claro	2	2
10403855	4800854	Fucsia	2	2
10403856	4800855	Mandarina	2	2
10403857	4800869	Lavanda	2	2
10403858	4800884	Coral	2	2



Carpeta de gomas y solapas Like 2 A4 Maxi polipropileno

Código	Ref.	Color	U/Vta	U/Emb
10403833	4800210	Negro	2	14
10403834	4800221	Verde	2	14
10403835	4800226	Mint	2	14
10403836	4800230	Azul	2	14
10403837	4800233	Azul claro	2	14
10403838	4800235	Morado	2	14
10403839	4800236	Turquesa	2	14
10403840	4800253	Rosa claro	2	14
10403841	4800254	Fucsia	2	14
10403842	4800255	Mandarina	2	14
10403843	4800269	Lavanda	2	14
10403844	4800284	Coral	2	14



Carpeta de anillas Like 2 A4+ polipropileno
4 anillas mixtas de 25mm

Código	Ref.	Color	U/Vta	U/Emb
10403875	30121610	Negro	2	14
10403876	30121621	Verde	2	14
10403877	30121626	Mint	2	14
10403878	30121630	Azul	2	14
10403879	30121633	Azul claro	2	14
10403880	30121635	Morado	2	14
10403881	30121636	Turquesa	2	14
10403882	30121653	Rosa claro	2	14
10403883	30121654	Fucsia	2	14
10403884	30121655	Mandarina	2	14
10403885	30121669	Lavanda	2	14
10403886	30121684	Coral	2	14



Carpeta de anillas Like 2 A4+ polipropileno
4 anillas mixtas de 25mm

Código	Ref.	Color	U/Vta	U/Emb
10403860	4800910	Negro	2	14
10403861	4800921	Verde	2	14
10403862	4800926	Mint	2	14
10403863	4800930	Azul	2	14
10403864	4800933	Azul claro	2	14
10403865	4800935	Morado	2	14
10403866	4800936	Turquesa	2	14
10403867	4800953	Rosa claro	2	14
10403868	4800954	Fucsia	2	14
10403869	4800955	Mandarina	2	14
10403870	4800969	Lavanda	2	14
10403871	4800984	Coral	2	14
10403872	4800999	Surtido	14	14



CIERRE CON
CREMALLERA



Carpebloc Like 2 A4 cartón forrado
4 anillas mixtas de 35mm
con recambio de 100 hojas

Código	Ref.	Color	U/Vta	U/Emb
10403888	88101310	Negro	2	2
10403889	88101321	Verde	2	2
10403890	88101326	Mint	2	2
10403891	88101330	Azul	2	2
10403892	88101333	Azul claro	2	2
10403893	88101335	Morado	2	2
10403894	88101336	Turquesa	2	2
10403895	88101353	Rosa claro	2	2
10403896	88101354	Fucsia	2	2
10403897	88101355	Mandarina	2	2
10403898	88101369	Lavanda	2	2
10403899	88101384	Coral	2	2
10403900	88101599	Surtido	12	12



Carpebloc Like 2 A4 polipropileno semirrígido opaco
4 anillas mixtas de 35mm, con recambio de 100 hojas

Código	Ref.	Color	U/Vta	U/Emb
10403901	88101810	Negro	2	2
10403902	88101821	Verde	2	2
10403903	88101826	Mint	2	2
10403904	88101830	Azul	2	2
10403905	88101833	Azul claro	2	2
10403906	88101835	Morado	2	2
10403907	88101836	Turquesa	2	2
10403908	88101853	Rosa claro	2	2
10403909	88101854	Fucsia	2	2
10403910	88101855	Mandarina	2	2
10403911	88101869	Lavanda	2	2
10403912	88101884	Coral	2	2
10403913	88101899	Surtido	12	12



Carpeta de fundas Like 2 F° Poliplus
polipropileno opaco semirrígido

• 10 fundas

Código	Ref.	Color	U/Vta	U/Emb
15302821	1430810	Negro	12	12
15302822	1430821	Verde	12	12
15302823	1430826	Mint	12	12
15302824	1430830	Azul	12	12
15302825	1430833	Azul claro	12	12
15302826	1430835	Morado	12	12
15302827	1430836	Turquesa	12	12
15302828	1430853	Rosa claro	12	12
15302829	1430854	Fucsia	12	12
15302830	1430855	Mandarina	12	12
15302831	1430869	Lavanda	12	12
15302832	1430884	Coral	12	12

• 20 fundas

Código	Ref.	Color	U/Vta	U/Emb
15302845	1450810	Negro	5	5
15302846	1450821	Verde	5	5
15302847	1450826	Mint	5	5
15302848	1450830	Azul	5	5
15302849	1450833	Azul claro	5	5
15302850	1450835	Morado	5	5
15302851	1450836	Turquesa	5	5
15302852	1450853	Rosa claro	5	5
15302853	1450854	Fucsia	5	5
15302854	1450855	Mandarina	5	5
15302855	1450869	Lavanda	5	5
15302856	1450884	Coral	5	5

• 30 fundas

Código	Ref.	Color	U/Vta	U/Emb
15302869	1470810	Negro	5	5
15302870	1470821	Verde	5	5
15302871	1470826	Mint	5	5
15302872	1470830	Azul	5	5
15302873	1470833	Azul claro	5	5
15302874	1470835	Morado	5	5
15302875	1470836	Turquesa	5	5
15302876	1470853	Rosa claro	5	5
15302877	1470854	Fucsia	5	5
15302878	1470855	Mandarina	5	5
15302879	1470869	Lavanda	5	5
15302880	1470884	Coral	5	5

• 40 fundas

Código	Ref.	Color	U/Vta	U/Emb
15302833	1440810	Negro	5	5
15302834	1440821	Verde	5	5
15302835	1440826	Mint	5	5
15302836	1440830	Azul	5	5
15302837	1440833	Azul claro	5	5
15302838	1440835	Morado	5	5
15302839	1440836	Turquesa	5	5
15302840	1440853	Rosa claro	5	5
15302841	1440854	Fucsia	5	5
15302842	1440855	Mandarina	5	5
15302843	1440869	Lavanda	5	5
15302844	1440884	Coral	5	5

• 50 fundas

Código	Ref.	Color	U/Vta	U/Emb
15302857	1460810	Negro	5	5
15302858	1460821	Verde	5	5
15302859	1460826	Mint	5	5
15302860	1460830	Azul	5	5
15302861	1460833	Azul claro	5	5
15302862	1460835	Morado	5	5
15302863	1460836	Turquesa	5	5
15302864	1460853	Rosa claro	5	5
15302865	1460854	Fucsia	5	5
15302866	1460855	Mandarina	5	5
15302867	1460869	Lavanda	5	5
15302868	1460884	Coral	5	5

3x 014313 (10 Fundas)
6x 014513 (20 Fundas)
5x 014713 (30 Fundas)
3x 014413 (40 Fundas)
3x 014613 (50 Fundas)

Carpebloc Centauro A4 cartón forrado 4 anillas mixtas
recambio 120h cuadrícula 4x4

Código	Ref.	U/Vta	U/Emb
15302819	13000	1	1



Bloc Kuru 2 80 hojas 90gr tapa polipropileno
Colores surtidos

Código	Ref.	Tamaño	Rayado	U/Vta	U/Emb
10003120	88423899	F°	Horizontal 7mm	12	12
10003121	88423999	F°	Cuadrícula 4x4	12	12
10003122	88433899	4°	Horizontal 7mm	12	12
10003123	88433999	4°	Cuadrícula 4x4	12	12



Carpeta de fundas Kuru 2 F° 30 fundas Poliplas
polipropileno opaco semirrígido

Código	Ref.	U/Vta	U/Emb
15302946	1471099	6	6



Carpebloc Kuru 2 A4 cartón forrado
4 anillas mixtas de 35mm con recambio de 100 hojas

Código	Ref.	Color	U/Vta	U/Emb
10403915	88103026	Mint	2	2
10403916	88103027	Lima	2	2
10403917	88103030	Azul	2	2
10403918	88103053	Rosa	2	2
10403919	88103069	Lavanda	2	2
10403920	88103083	Melocotón	2	2
10403921	88103199	Surtido	12	12



Carpeta de anillas Kuru 2 A4+ cartón forrado
4 anillas mixtas

Código	Ref.	Anillas	U/Vta	U/Emb
10403873	07322399	40mm	6	6
10403874	07322699	25mm	12	12



Carpeta de proyectos Kuru 2 Ecoproject F° con gomas
Colores surtidos

Código	Ref.	Lomo	U/Vta	U/Emb
10403923	91272499	3cm	6	6
10403924	91272799	5cm	6	6



Carpeta de fundas Kuru 2 Maxiplas A4 40 fundas
polipropileno opaco rígido con espiral
6 colores surtidos

Código	Ref.	U/Vta	U/Emb
15302947	39823199	6	6



Carpeta de gomas y solapas Kuru 2 F°
cartón forrado

Código	Ref.	U/Vta	U/Emb
10403846	1222399	6	6



Mochila Roomy Kuru 2 adaptable a carro
3 compartimentos

Código	Ref.	Color	U/Vta	U/Emb
11001154	37503226	Mint	1	10
11001155	37503227	Lima	1	10
11001156	37503230	Azul	1	10
11001157	37503253	Rosa	1	10
11001158	37503269	Lavanda	1	10
11001159	37503283	Melocotón	1	10



Portatodo Roomy Kuru 2 con solapa
3 cremalleras

Código	Ref.	Color	U/Vta	U/Emb
11301959	37547026	Mint	1	50
11301960	37547027	Lima	1	50
11301961	37547030	Azul	1	50
11301962	37547053	Rosa	1	50
11301963	37547069	Lavanda	1	50
11301964	37547083	Melocotón	1	50

Novedad
N

Novedad
N

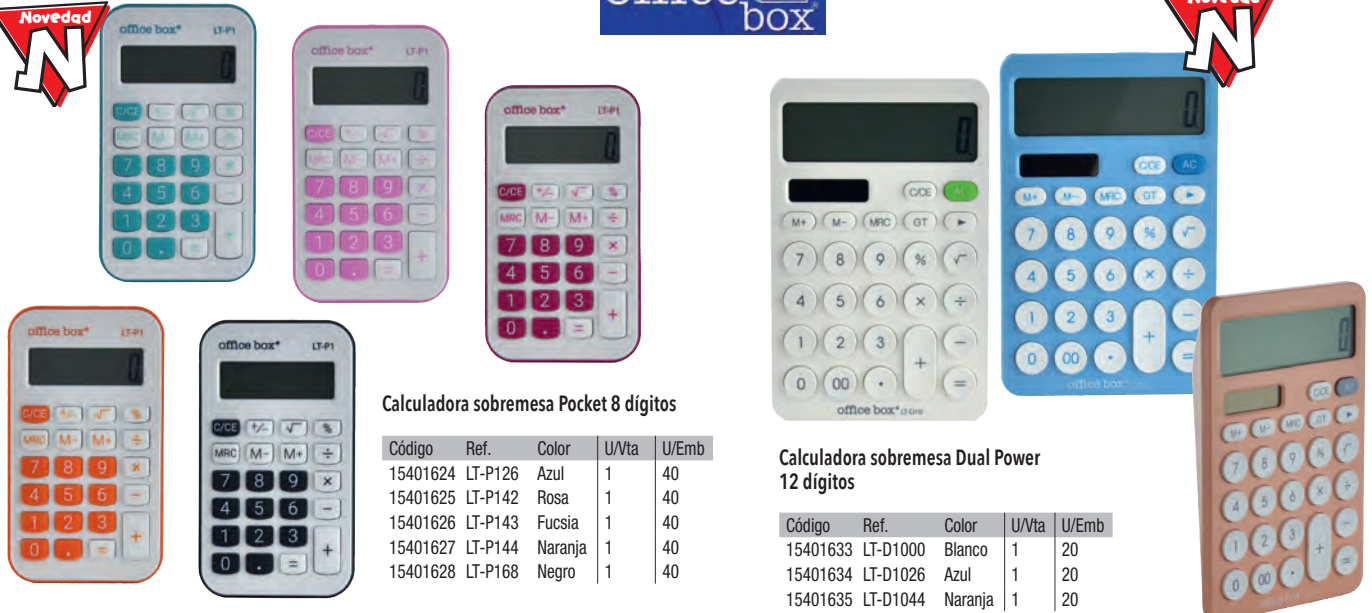

Calculadora sobremesa Pocket 8 dígitos

Código	Ref.	Color	U/Vta	U/Emb
15401624	LT-P126	Azul	1	40
15401625	LT-P142	Rosa	1	40
15401626	LT-P143	Fucsia	1	40
15401627	LT-P144	Naranja	1	40
15401628	LT-P168	Negro	1	40

Calculadora sobremesa Dual Power 12 dígitos

Código	Ref.	Color	U/Vta	U/Emb
15401633	LT-D1000	Blanco	1	20
15401634	LT-D1026	Azul	1	20
15401635	LT-D1044	Naranja	1	20



Novedad
N

Calculadora científica 10 + 2 dígitos (2 líneas)

Código	Ref.	Color	U/Vta	U/Emb
15401629	LT-C100	Blanco	1	20
15401630	LT-C126	Azul	1	20
15401631	LT-C142	Rosa	1	20
15401632	LT-C168	Negro	1	20

FORRALIBROS Express

- ALTURA 22CM
- ALTURA 28CM
- ALTURA 29CM
- ALTURA 30CM
- ALTURA 31CM

Forrado en segundos 15

FÁCIL

CONTIENE 10 UNIDADES

29 centímetros ALTURA

Forra en 15 segundos con 4 sencillos pasos

REF. 32961

3 Tarjetas portanombre



Daniel Pérez Ruiz
3º B

3 Tarjetas portanombre

NO HAY QUE COMPRAR ETIQUETAS, 3 INCLUIDAS EN CADA FORRALIBROS

1234 PASOS 15 SEG

Forra tu libro en sólo 4 pasos, sigue las instrucciones en el dorso

DISPONIBLE EN LAS REF. 32861 - 32961 - 33061



Corrector casete 5 mm x 6 m
Con goma

Código	Ref.	U/Vta	U/Emb
15103278	6795	25	3000



Recambio corrector cinta duo 5 mm x 6 m
Expositor de 24

Código	Ref.	U/Vta	U/Emb
23101044	1795	1	1



Cinta correctora X-large 16 m x 5 mm
Expositor de 20

Código	Ref.	U/Vta	U/Emb
15101062	6816	1	12



Corrector cinta supra 4,2mm x 6 m
Expositor de 25

Código	Ref.	U/Vta	U/Emb
23101033	D6793	1	12



Recambio corrector cinta supra 4,2mm x 6 m
Expositor de 24

Código	Ref.	U/Vta	U/Emb
23101034	1642	1	24



Cinta correctora micro 6 metros x 5mm.
Expositor de 36

Código	Ref.	U/Vta	U/Emb
15101061	6806	1	12



Portatodo 3D Magic simple 22x11x6 cm
6 modelos surtidos

Código	Ref.	U/Vta	U/Emb
11301905	59801	12	48



Plumier 3D Magic
6 modelos surtidos

Código	Ref.	U/Vta	U/Emb
11302109	59821	1	36



Portatodo rectangular rectangular
Colores surtidos

Código	Ref.	Tamaño	U/Vta	U/Emb
11301944	58101	Boys	10	60
11301945	58102	Girls	10	60



Carpeta con pinza portablocs multitaladro A4
Expositor surtido de 36

Código	Ref.	U/Vta	U/Emb
10403739	9311	1	36



Carpebloc A4 4 anillas mixtas de 32mm automáticas
con recambio cuadrícula 5x5, 100h de 90g

Código	Ref.	U/Vta	U/Emb
10403328	43211	8	8

Cierre con gomas
10 separadores extra rígidos
con indicadores y bolsillo



Carpeta de fundas A4 polipropileno
colores surtidos

Código	Ref.	Artículo	U/Vta	U/Emb
15301490	2011	20 fundas	24	24
15301491	4011	40 fundas	16	16



Carpeta portadocumentos Zipper Supra
con cremallera 360x280mm 4 anillas 25mm

Código	Ref.	U/Vta	U/Emb
10414120	57415	1	40



Dossier Clip OB Clip-it, A4 30h.
Expositor de 48

Código	Ref.	U/Vta	U/Emb
18001619	60111-EXP	1	3



Dossier sobre PP velcro

Código	Ref.	Tamaño	U/Vta	U/Emb
18001543	90111	A4+	120	360
18001544	90411	A5	120	480



Carpeta gomas y solapas polipropileno
XXL con fuelle

Código	Ref.	U/Vta	U/Emb
10417343	51311	1	16





Clasificador acordeón PP 335x240
7 departamentos, desplegable

Código	Ref.	U/Vta	U/Emb
10303077	47011	1	8



Clasificador acordeón PP 335x240
12 departamentos, con ribetes y gomas

Código	Ref.	U/Vta	U/Emb
10417342	41211	1	24



Carpeta de 4 anillas A4 polipropileno
con tarjetero

Código	Ref.	Anillas	U/Vta	U/Emb
10417303	42511	25mm	16	64
10403995	44011	40mm	16	64



Clasificador acordeón Vision PP A4+
12 sobres con cremallera 9 colores

Código	Ref.	U/Vta	U/Emb
10303116	41811	1	16



Clasificador Plus, 12 divisores, Polipropileno
Tarjetero identificativo, gomas, y excelente acabado.

Código	Ref.	U/Vta	U/Emb
10417344	41311	1	16



Carpeta con Gomas y Solapas A4
Polipropileno. Gomas del mismo color.

Código	Ref.	Artículo	U/Vta	U/Emb
10417347	51211	Normal	48	96
10401675	51811	Maxi	48	96



Carpeta Zipper con cremallera
330x260 mm.

Código	Ref.	U/Vta	U/Emb
10417345	57511	1	16



Separadores A4 10 pestañas con bolsillo
11 taladros

Código	Ref.	U/Vta	U/Emb
20401223	93211	1	100



Porta lápices Colores Surtidos - Cierre Cremallera

Código	Ref.	Artículo	U/Vta	U/Emb
24308131	59411	Mini	1	240
24308130	59311	Cuadrado	1	96



Portatodo surtido

Código	Ref.	Artículo	U/Vta	U/Emb
11303005	59811	Doble	1	64
11303127	58311	Triple	1	64



Portatodo redondo surtido

Código	Ref.	U/Vta	U/Emb
24304790	59511	1	96



Portatodo Blush pastel triple surtido

Código	Ref.	U/Vta	U/Emb
11302110	58305	1	50



Portatodo plano surtido

Código	Ref.	U/Vta	U/Emb
11301231	58011	1	240



Mega Portatodo con solapa interior

Código	Ref.	U/Vta	U/Emb
11303004	59711	1	64



Portatodo silicona plano surtido

Código	Ref.	U/Vta	U/Emb
11301230	58711	1	96



Portatodo silicona surtido

Código	Ref.	U/Vta	U/Emb
11301212	58111	1	64



Portatodo silicona redondo surtido

Código	Ref.	U/Vta	U/Emb
11303202	58511	1	10



Portatodo rectangular neopreno

Código	Ref.	U/Vta	U/Emb
11303024	59380	1	100



Portatodo mini neopreno surtido

Código	Ref.	U/Vta	U/Emb
11303205	59480	1	200



Carpeta con pinza portabloc PP Fº surtido

Código	Ref.	U/Vta	U/Emb
24312023	9215	10	60



Carpeta con pinza portabloc Fº plástico rígido, con falsilla colores surtidos

Código	Ref.	U/Vta	U/Emb
10401685	9211	10	20



Regla mini ruler 15cm Bote de 40

Código	Ref.	U/Vta	U/Emb
25501139	31611	1	10



Regla enrollable de silicona 30cm Expositor de 36

Código	Ref.	U/Vta	U/Emb
25501073	30311	1	4



Regla cerrada de 15 cm, abierta de 30 cm y transportador 180º

Regla Easy 3 en 1 Expositor de 24

Código	Ref.	U/Vta	U/Emb
25501122	31511	1	10



Portanombre con colgador adaptable Expositor de 24

Código	Ref.	U/Vta	U/Emb
19801502	30011	1	6



Portarrollos mini 33m 3 colores surtidos

Código	Ref.	U/Vta	U/Emb
16601078	0521-M	1	12



Portarrollos mediano 33m/66m 3 colores surtidos

Código	Ref.	U/Vta	U/Emb
16601079	0517	1	12



Portarrollos grande 33m/66m con cubilete 3 colores surtidos

Código	Ref.	U/Vta	U/Emb
16601073	0516	1	12



Bolsa multiuso con cierre de cremallera

Código	Ref.	Medidas	Color	U/Vta	U/Emb
18002046	34114	A4	Azul	10	50
18002047	34115	A5	Amarillo	10	50
18002049	34116	A6	Naranja	10	50
18002057	34117	200x90 mm	Violeta	10	50
18002058	34124	410x300 mm	Verde	10	50
18002059	34125	285x225 mm	Negro	10	50
18002060	34126	200x165 mm	Rojo	10	50



Botella B-Water Flex plegable Silicona de 550ml

Código	Ref.	U/Vta	U/Emb
15801048	85811	8	48



Portatodo simple redondo Propyglass 22x7 cm
4 colores surtidos

Código	Ref.	U/Vta	U/Emb
11301912	630083-30	1	18



Portatodo Latas
4 modelos surtidos

Código	Ref.	U/Vta	U/Emb
11301965	097601-06	20	20



Portatodo simple redondo Rainbow
2 colores pastel surtidos

Código	Ref.	U/Vta	U/Emb
11302108	837352-05	1	12



Portatodo simple semi redondo
20x6x8,5 cm
6 colores surtidos

Código	Ref.	U/Vta	U/Emb
11301918	833723-10	1	36



Portatodo simple Stripe 22x7,5x5 cm
5 colores surtidos

Código	Ref.	U/Vta	U/Emb
11301915	822346-10	1	36



Portatodo doble Teknik Classic 22x9x7 cm
3 colores surtidos

Código	Ref.	U/Vta	U/Emb
11301921	877348-05	1	12



Portatodo doble Teknik pastel
3 colores surtidos

Código	Ref.	U/Vta	U/Emb
11301946	887348-05	1	12



Portatodo triple Teknik
2 colores pastel surtidos

Código	Ref.	U/Vta	U/Emb
11302107	787348-05	1	12



Portatodo triple Trizip 22x9x8,5 cm
3 colores surtidos

Código	Ref.	U/Vta	U/Emb
11301914	777348-05	1	12



Portatodo triple Trizip Girl
22x9x9 cm
3 colores surtidos

Código	Ref.	U/Vta	U/Emb
11301920	876956-05	1	12



Portatodo 4 cremalleras Teknik 4+ Maxi
22x9x9 cm
4 colores surtidos

Código	Ref.	U/Vta	U/Emb
11301913	769348-05	1	12



Portatodo plumier Teknik
3 colores surtidos

Código	Ref.	U/Vta	U/Emb
11301947	778348-30	1	18



Taco de notas 100 hojas

Código	Ref.	Artículo	U/Vta	U/Emb
26901066	3653-01	50 x 40	12	360
26901067	3654-01	75 x 75	12	120
26901068	3656-01	50 x 75	12	240
26901069	3655-01	125 x 75	12	240



Taco de notas cubo 400 hojas 75x75 amarillo

Código	Ref.	U/Vta	U/Emb
26901070	3820-01	1	60



Taco de notas Z 100 hojas 75x75

Código	Ref.	U/Vta	U/Emb
26901071	3644-01	12	120



Taco de notas cubo 320 hojas 75x75 colores brillantes

Código	Ref.	U/Vta	U/Emb
26901076	3654-39	1	60



Taco de notas 100 hojas 75x75

Código	Ref.	Colores	U/Vta	U/Emb
26901077	3654-39-PK1B	Brillantes	12	120
26901079	3654-98-PK1B	Pastel	12	120

Taco de notas 80 hojas 75x75

Código	Ref.	Color	U/Vta	U/Emb
26901072	3654-32	Rosa	12	120
26901073	3654-33	Verde	12	120
26901074	3654-34	Amarillo	12	120
26901075	3654-35	Naranja	12	120



Taco de notas cubo 400 hojas 75x75 colores pastel

Código	Ref.	U/Vta	U/Emb
26901078	3820-98	1	60



Banderitas adhesivas 20x50 colores brillantes pack 4

Código	Ref.	U/Vta	U/Emb
26901082	3670-39	12	240



Banderitas adhesivas 12x50 flecha Pack 5

Código	Ref.	U/Vta	U/Emb
26901080	3682-09	12	240



Banderitas adhesivas 12x50 Pack 5

Código	Ref.	U/Vta	U/Emb
26901081	3681-09	12	240



Banderitas adhesivas 1/2" Pack 4

Código	Ref.	U/Vta	U/Emb
26901083	3627-75	12	144



Para niños de más de 5 años

Máquina rotular Omega (12749)

Código	Ref.	U/Vta	U/Emb
21701034	S0717940	1	6



Para niños de más de 5 años

Máquina rotular junior (12747)

Código	Ref.	U/Vta	U/Emb
21701033	S0717910	1	6



5x S0717940 máquina Omega
16x S0847750 Blister de 3 (negro, azul y rojo)

Máquina rotular manual Omega Expositor de 5

Código	Ref.	U/Vta	U/Emb
16701197	2168570	1	1



Portátil

Máquina de rotular electrónica 160 (D1) Label Manager 160 (portable)

Código	Ref.	U/Vta	U/Emb
21701094	2174612	1	1



Portátil

Máquina rotular Letratag Lt 100-H portable

Código	Ref.	U/Vta	U/Emb
21701056	2174576	1	6



Portátil



Máquina de rotular electrónica LT200-B Bluetooth (portable)

Código	Ref.	U/Vta	U/Emb
16701201	2172855	1	1



Impresora de etiquetas Label Writer inalámbrico color negro y plata

Código	Ref.	U/Vta	U/Emb
16701110	2000931	1	1

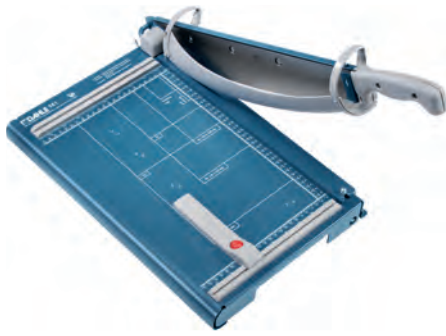

Cizalla de palanca 561 A4 de seguridad
corte: longitud 360mm y capacidad 3,5mm ± 35h

Código	Ref.	U/Vta	U/Emb
11701004	00561-21285	1	60

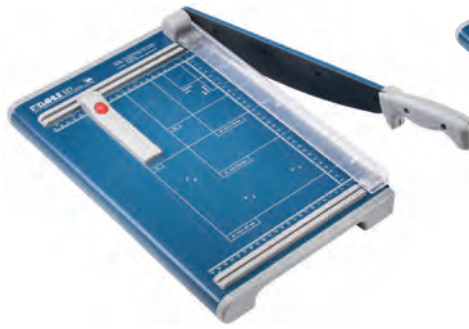

Cizalla de palanca 533 A4
corte: longitud 340mm y capacidad 1,5mm ± 15h

Código	Ref.	U/Vta	U/Emb
11701039	00533-21247	1	60

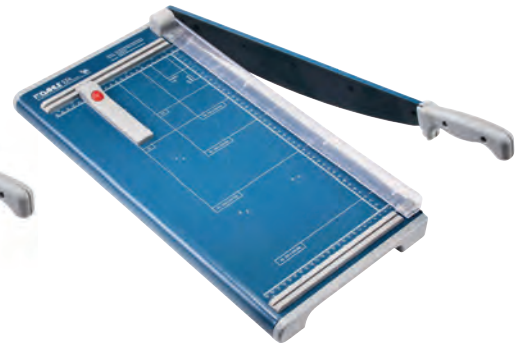

Cizalla de palanca 534 A3
corte: longitud 460mm y capacidad 1,5mm ± 15h

Código	Ref.	U/Vta	U/Emb
11701017	00534-21249	1	60



Cizalla de palanca Premium 867 A3
corte: longitud 460mm y capacidad 3,5mm ± 35h

Código	Ref.	U/Vta	U/Emb
11701018	00867-20504	1	60



Cizalla de rodillo 507 A4
corte: longitud 320mm y capacidad 0,8mm ± 8h

Código	Ref.	U/Vta	U/Emb
11702001	00507-24040	1	60



Cizalla de rodillo 508 A3
corte: longitud 460mm y capacidad 0,6mm ± 6h

Código	Ref.	U/Vta	U/Emb
11702002	00508-24050	1	60



Destructora 306 MPH Team
18/20 hojas en partículas de 5x50mm
Nivel de seguridad 3. Depósito de 60L.

Código	Ref.	U/Vta	U/Emb
16401377	50310-14000	1	1



Destructora PS 240
10 hojas en partículas de 4x12mm
Nivel de seguridad 4. Depósito de 25L.

Código	Ref.	U/Vta	U/Emb
16401423	23240-16171	1	1



Destructora automática Shredmatic 90
10/90 hojas en partículas de 4x12mm
Nivel de seguridad 4. Depósito de 23L.

Código	Ref.	U/Vta	U/Emb
16401412	35090-16180	1	1



Destructora automática Shredmatic 300
14/300 hojas en partículas de 4x15mm
Nivel de seguridad 4. Depósito de 40L.

Código	Ref.	U/Vta	U/Emb
16401384	35314-15092	1	1



Plastificadora térmica 4 rodillos
Negro

Código	Ref.	Artículo	U/Vta	U/Emb
19201106	70303-14588	A3	1	1
19201107	70304-14587	A4	1	1

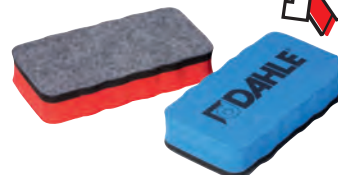

Borrador imantado

Código	Ref.	Color	U/Vta	U/Emb
15101087	95097-02505	Azul	1	1
15101086	95097-02504	Rojo	1	1



Afilalápiz eléctrico profesional 210

Código	Ref.	Color	U/Vta	U/Emb
13701225	00210-14411	Blanco	1	240
13701226	00210-14410	Negro	1	240



Grapadora tenaza B39 (50h)

Código	Ref.	U/Vta	U/Emb
12901409	021-0094	1	1



Grapadora mini (12h)
Caja de 1000 grapas 24/6 incluida

Código	Ref.	Color	U/Vta	U/Emb
12901456	020-1907	Negro	1	6
12901457	020-1908	Azul	1	6
12901458	020-1909	Verde	1	6
12901459	020-1910	Rosa	1	6



Grapadora B2 RE+NEW negro (25h)
Fabricada en material reciclado.

Código	Ref.	U/Vta	U/Emb
12901413	020-1931	1	20



Grapadora B4 RE+NEW negro (40h)
Fabricada en material reciclado.

Código	Ref.	U/Vta	U/Emb
12901452	020-1932	1	20



Grapadora Harmony B4FC RE+NEW negro (50h)
Fabricada en material reciclado. Grapado plano

Código	Ref.	U/Vta	U/Emb
12901427	020-1933	1	1



Taladro 2 punzones Harmony B230
RE+NEW negro (30h)

Código	Ref.	U/Vta	U/Emb
13101150	025-0637	1	1



Taladro 4 punzones B-425 negro (25h)

Código	Ref.	U/Vta	U/Emb
13101171	025-0469	1	1



Grapadora B50 negro (200h)
Para gruesos

Código	Ref.	U/Vta	U/Emb
12901545	023-0065	1	1



Taladro 2 punzones B265 (65h)
Gris/negro

Código	Ref.	U/Vta	U/Emb
13101252	025-0266	1	1



Taladro 2 punzones B2200 RE+NEW negro (200h)
Gran capacidad

Código	Ref.	U/Vta	U/Emb
13101322	025-0651	1	1

Exclusivo
DISTRISANTIAGO



Grapadora ST40 negro (40h)

Código	Ref.	U/Vta	U/Emb
12901431	020-1739	1	1



Grapadora ST25 negro (25h)

Código	Ref.	U/Vta	U/Emb
12901430	020-1711	1	1



Grapadora ST15 negro (15h)

Código	Ref.	U/Vta	U/Emb
12901429	020-1903	1	1



Grapadora ST50FC negro (50h)
Grapado plano

Código	Ref.	U/Vta	U/Emb
12901432	020-1840	1	1



Grapadora ST100 negro (100h)
Grapado plano

Código	Ref.	U/Vta	U/Emb
12901433	023-0058	1	1



Taladro 2 punzones negro

Código	Ref.	Artículo	U/Vta	U/Emb
13101152	025-0581	16 hojas	1	1
13101153	025-0508	25 hojas	1	1
13101154	025-0582	40 hojas	1	1

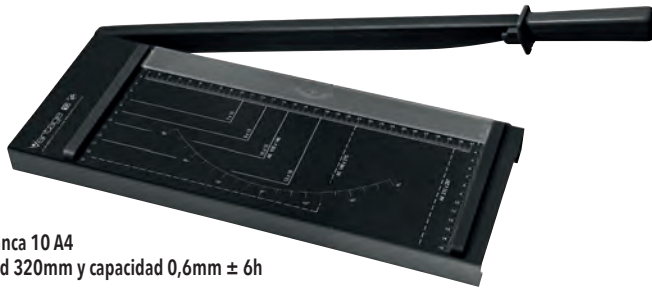

Cizalla de palanca 10 A4

Corte: Longitud 320mm y capacidad 0,6mm ± 6h

Código	Ref.	U/Vta	U/Emb
11701064	40010-20057	1	1

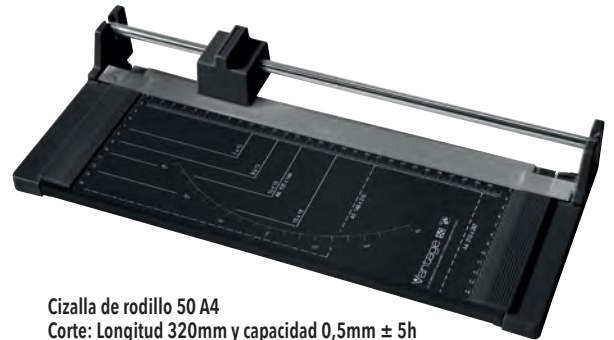

Cizalla de rodillo 50 A4

Corte: Longitud 320mm y capacidad 0,5mm ± 5h

Código	Ref.	U/Vta	U/Emb
11701065	40050-20059	1	1



Novedad

Regla de corte 31cm negra

Código	Ref.	U/Vta	U/Emb
25201819	40001-16868	1	1

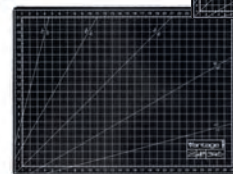
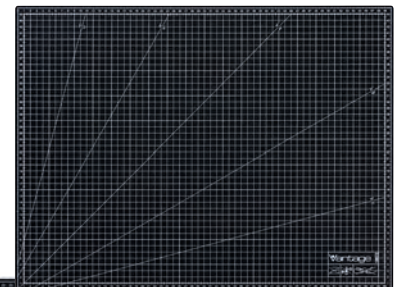

Plancha de corte negra

Código	Ref.	Artículo	U/Vta	U/Emb
25201727	10670-20142	A4	1	12
25201728	10671-20143	A3	1	12
25201729	10672-20144	A2	1	6
25201730	10673-20145	A1	1	6
25201731	10674-20146	A0	1	6



Grapadora tenaza 81 Porpoise (50h)

Código	Ref.	Color	U/Vta	U/Emb
12901365	1345	Rosa	1	40
12901366	1346	Azul	1	40



Grapadora ECO HD-100 para gruesos antibacteriano (100h) blanco

Código	Ref.	U/Vta	U/Emb
12901363	1386	1	18



Grapadora ECO Luna antibacteriano (50h) (grapas 24/6-8mm) negro

Código	Ref.	U/Vta	U/Emb
12901448	1466	1	36



Grapadora Bowfin metálica (25h) negro

Código	Ref.	U/Vta	U/Emb
12901358	R53500B2	1	72

INCLUYE 1000 GRAPAS



Grapadora Bug Mini (12h)

Código	Ref.	Color	U/Vta	U/Emb
12901355	1411	Verde	1	288
12901356	1412	Rosa	1	288
12901354	1410	Naranja	1	288

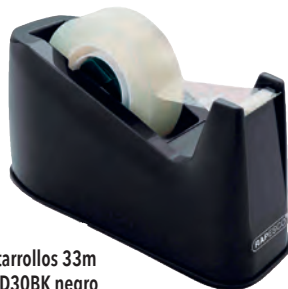

Portarrollos 33m RPTD30BK negro

Código	Ref.	U/Vta	U/Emb
24303050	RPTD30BK	1	20



Novedad

ANTIBACTERIANO

Tijeras con mango suave 21cm Paquete de 3 (colores surtidos)

Código	Ref.	U/Vta	U/Emb
27601292	1667	10	60



Novedad

Carpeta con pinza portabloc A4 Pack de 4

Código	Ref.	Color	U/Vta	U/Emb
10403996	1698	Azul	1	18
10403798	1641	Negro	1	18

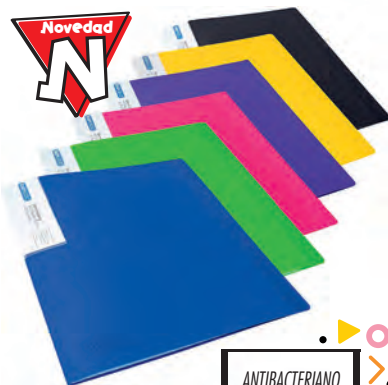

Carpeta de fundas A4 PP Pack surtido de 6

Código	Ref.	Artículo	U/Vta	U/Emb
15302810	1646	20 fundas	1	288
15302960	1647	40 fundas	1	288

ANTIBACTERIANO



Novedad

Dosier sobre broche A4 PP traslúcido Pack de 5

Código	Ref.	U/Vta	U/Emb
18001929	0700	10	60

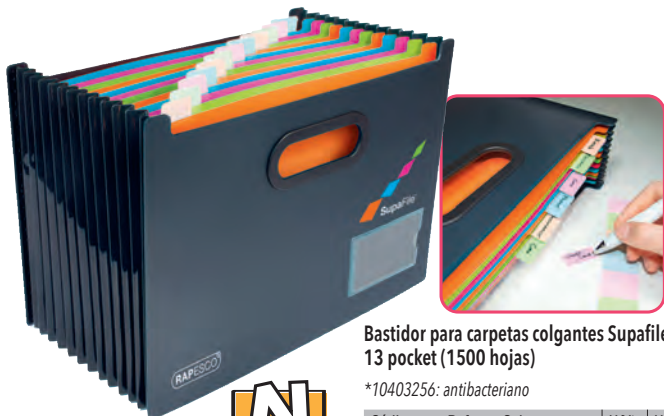

Bastidor para carpetas colgantes Supafile A4 13 pocket (1500 hojas)

*10403256: antibacteriano

Código	Ref.	Color	U/Vta	U/Emb
10403256	1489	Negro	1	10
10403997	1624	Negro/blanco	1	10

N
Nuevo modelo



Porta clips Supaclip 40

Código	Ref.	U/Vta	U/Emb
24301574	RC4025MC	1	200



Novedad

Pinza pala abatible colores 19mm Caja de 80

Código	Ref.	U/Vta	U/Emb
23601076	1428	1	10



Lámpara sobremesa Led 3W Ukky blanco

Código	Ref.	U/Vta	U/Emb
15501119	400140699	1	40



Lámpara sobremesa Led 12,6W Baya Bamboo

Código	Ref.	U/Vta	U/Emb
15501116	400140800	1	12



Lámpara de pie Led 44,6W Baly Bamboo

Código	Ref.	U/Vta	U/Emb
15501117	400140805	1	1



Perchero de pie Flora negro metálico 6 colgadores con paraguero

Código	Ref.	U/Vta	U/Emb
16201295	100340711	1	1



Perchero de pie Accueil metálico 8 bolas 175x35 con paraguero

Código	Ref.	Color	U/Vta	U/Emb
16201292	100340694	Negro	1	1
16201293	100340698	Gris	1	1



Reloj pared Pop analógico 28cm ø (pila incluida)

Código	Ref.	Color	U/Vta	U/Emb
15701038	400094281	Negro	1	10
15701039	400094282	Blanco	1	10



Reloj pared Pop maxi negro 37,5cm ø (pila incluida)

Código	Ref.	U/Vta	U/Emb
15701040	400094487	1	5



Reloj de pared Palma Bamboo analógico 30,5cm ø

Código	Ref.	U/Vta	U/Emb
15701028	400140806	1	8

Separadores PP A4 extrafuerte, 11 taladros

Código	Ref.	Pestañas	U/Vta	U/Emb
20401013	49050499	4	1	60
20401017	49050699	6	1	40
20401157	49051099	10	10	30

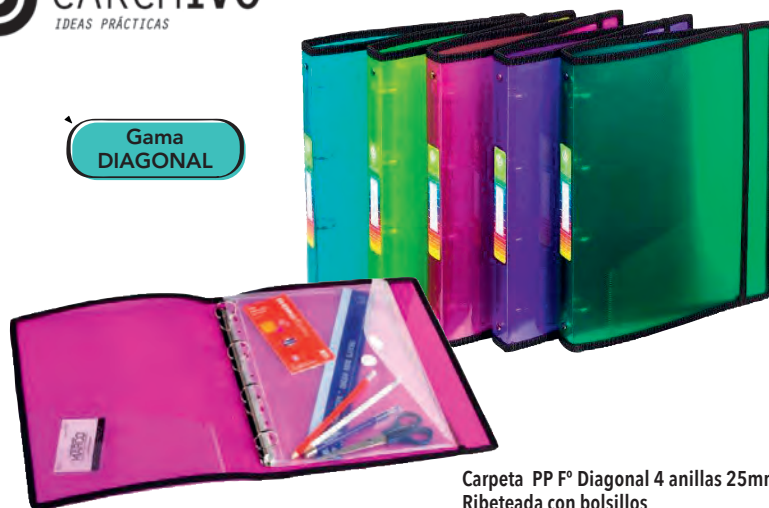
**Gama
DIAGONAL**
**Carpeta PP F° Diagonal 4 anillas 25mm
Ribeteada con bolsillos
Surtido**

Código	Ref.	U/Vta	U/Emb
10412350	7402KE	1	12

**Gama
DUNE**

**Carpeta de anillas Dune PP A4+ 4 Anillas
Reforzada con ribete de tela en todo su contorno y etiqueta en el lomo.**

Código	Ref.	Color	Anillas	U/Vta	U/Emb
10402838	12371450	Azul	40mm	4	12
10402839	12371451	Verde	40mm	4	12
10402840	12371452	Naranja	40mm	4	12
10402841	12371453	Rojo	40mm	4	12
10402842	12371456	Violeta	40mm	4	12
10403327	12371406	Negro	40mm	4	12
10402836	12379900	Expositor 12	25mm	1	1

**Carpebloc Dune A4 PP
4 anillas mixtas 20mm
Recambio de 100h 90g
cuadrícula 5x5
Expositor de 10**

Código	Ref.	U/Vta	U/Emb
10401047	12379700	1	1

**Gama
LUZ**

**Carpeta F° gomas y solapas cartón
Prespán Luz**

Código	Ref.	U/Vta	U/Emb
10417208	2033LE	1	30

**Carpeta de anillas Luz cartón plastificado brillo A4
4 anillas mixtas**

Código	Ref.	Anillas	Surtido	U/Vta	U/Emb
10403932	12180497	25 mm	10 uds	1	2
10401507	12181499	40 mm	8 uds	1	2



Gama ARCHIVEX-STAR



Carpeta fundas Archivex-Star A4 kangaroo PP espiral, con goma Expositor de 15

Código	Ref.	U/Vta	U/Emb
15302170	53038800	1	1



Contenido:
4x 20 Fundas
5x 30 Fundas
3x 40 Fundas
2x 50 Fundas
1x 60 Fundas

Carpeta fundas Archivex-Star A4 PP espiral, con goma Expositor de 15

Código	Ref.	U/Vta	U/Emb
15302075	53028800	1	1



Carpeta kangaroo de fundas Archivex-Star A4 espiral PP Cierre con gomas y sobre de polipropileno Colores surtidos

Código	Ref.	Fundas	U/Vta	U/Emb
15302133	53032099	20	1	12
15302142	53033099	30	1	8
15302151	53034099	40	1	8
15302160	53035099	50	1	8
15302169	53036099	60	1	8



Carpeta fundas Archivex-Star espiral PP A4 Con goma y sobre de polipropileno Colores surtidos

Código	Ref.	Fundas	U/Vta	U/Emb
15302038	53022099	20	1	12
15302047	53023099	30	1	8
15302056	53024099	40	1	8
15302065	53025099	50	1	8
15302074	53026099	60	1	8

Carpeta de fundas kangaroo Archivex-Star A4 espiral PP Cierre con gomas y sobre de polipropileno 80 fundas

Código	Ref.	Color	U/Vta	U/Emb
15302723	53038006	Negro	2	6
15302724	53038050	Azul	2	6
15302725	53038053	Rojo	2	6



Carpeta gomas y solapas PP F° 6 colores traslúcidos

Código	Ref.	U/Vta	U/Emb
10404222	2033KFE	6	30

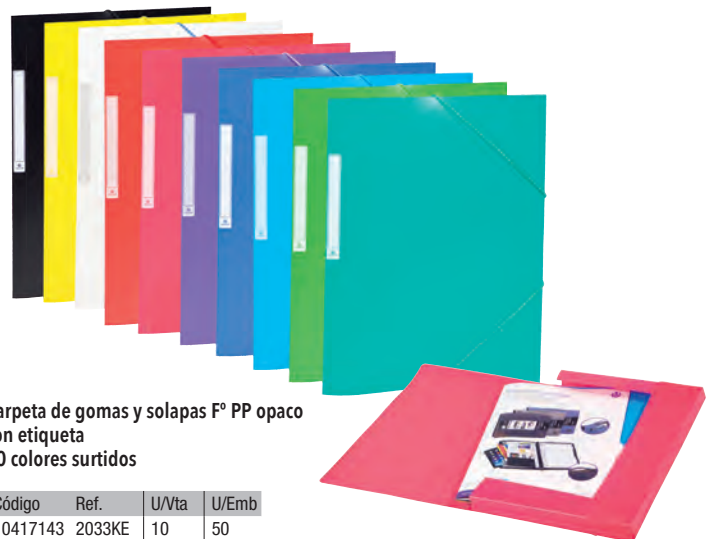

Carpeta de gomas y solapas F° PP opaco con etiqueta 10 colores surtidos

Código	Ref.	U/Vta	U/Emb
10417143	2033KE	10	50



Gama REMOVE



Carpeta de fundas canguro Remove A4 PP espiral con goma y sobre de polipropileno. Fundas extraíbles

Código	Ref.	Fundas	Color	U/Vta	U/Emb	Código	Ref.	Fundas	Color	U/Vta	U/Emb
15302450	54002006	20	Negro	2	10	15302457	54003006	30	Negro	2	10
15302451	54002021	20	Verde	2	10	15302458	54003021	30	Verde	2	10
15302453	54002050	20	Azul	2	10	15302460	54003050	30	Azul	2	10
15302454	54002053	20	Rojo	2	10	15302461	54003053	30	Rojo	2	10
15302953	54002054	20	Verde	2	10	15302954	54003054	30	Verde	2	10
15302456	54002062	20	Violeta	2	10	15302463	54003062	30	Violeta	2	10



Clasificador acordeón F° polipropileno translúcido 13 departamentos, con goma Expositor surtido de 12

Código	Ref.	U/Vta	U/Emb
10301750	1913KE	1	1



Carpeta con gomas y solapas PP 4° translúcido Flúor

Código	Ref.	U/Vta	U/Emb
10402271	2025KF	10	40



Carpeta de dibujo A3 PP translúcido gomas y solapas

Código	Ref.	Color	U/Vta	U/Emb
10411040	2034K50	Azul	1	25
10411041	2034K51	Verde claro	1	25
10411042	2034K52	Naranja	1	25
10411043	2034K53	Rojo	1	25
10411044	2034K54	Verde	1	25

Gama FOAM STYLE



Carpeta polipropileno Foam Style A4 Miniclip superior con pinza Tapa y goma a juego

Código	Ref.	Color	U/Vta	U/Emb
10403322	63040106	Negro	4	16
10403323	63040109	Azul	4	16
10403324	63040112	Rojo	4	16
10403325	63040116	Verde	4	16
10403326	63040199	Surtido	12	12

Carpebloc Foam Style A4 apertura total 360° polipropileno extra rígido y ultra ligero 4 anillas mixtas 35mm Recambio de 100h 90g, cuadrícula 5x5

Código	Ref.	Color	U/Vta	U/Emb
10403317	12407406	Negro	4	8
10403318	12407409	Azul	4	8
10403319	12407412	Rojo	4	8
10403320	12407416	Verde	4	8
10403934	12407462	Violeta	4	8
10403321	12407499	Surtido	8	8



INCLUYE SOBRE DE POLIPROPILENO 4 SEPARADORES EXTRA RIGIDOS EN COLORES FASHION



Bloc Ingeniox Pastel 100h 100g tapa polipropileno Cuadrícula 5x5

• A4

Código	Ref.	Color	U/Vta	U/Emb
10002801	66004110	Azul	2	10
10002802	66004114	Malva	2	10
10002803	66004117	Menta	2	10
10002804	66004125	Rosa	2	10
10003166	66004121	Verde	2	10
10002805	66004199	Surtido	10	10

• A5

Código	Ref.	Color	U/Vta	U/Emb
10002807	66005110	Azul	2	10
10002808	66005114	Malva	2	10
10002809	66005117	Menta	2	10
10002810	66005125	Rosa	2	10
10003172	66005121	Verde	2	10
10002811	66005199	Surtido	10	10



Bloc Ingeniox Intense A4 100h 100g tapa polipropileno Cuadrícula 5x5

• A4

Código	Ref.	Color	U/Vta	U/Emb
10003162	66004111	Azul	2	10
10002800	66004108	Gris	2	10
10003165	66004119	Mostaza	2	10
10003163	66004112	Rojo	2	10
10003164	66004116	Verde	2	10
10003167	66004198	Surtido	10	10

• A5

Código	Ref.	Color	U/Vta	U/Emb
10003168	66005111	Azul	2	10
10002806	66005108	Gris	2	10
10003171	66005119	Mostaza	2	10
10003169	66005112	Rojo	2	10
10003170	66005116	Verde	2	10
10003173	66005198	Surtido	10	10



Contenido:
4x A4
8x A5

Bloc Ingeniox A4/A5 100h 100g tapa polipropileno Cuadrícula 5x5 Expositor surtido de 12

Código	Ref.	Artículo	U/Vta	U/Emb
10002953	66009000	Col. Intense	1	1
10002824	66008900	Col. Pastel	1	1



Banderitas adhesivas Ingeniox Colores neón

Código	Ref.	U/Vta	U/Emb
26901416	66172299	10	250



Marcapáginas Ingeniox polipropileno extra fuerte 4 unidades

Código	Ref.	Color	U/Vta	U/Emb
20401192	66164199	Intensos	10	250
20401191	66164099	Pastel	10	250



Separadores Ingeniox polipropileno extra fuerte 4 pestañas

• Colores Intensos

Código	Ref.	Artículo	U/Vta	U/Emb
20401211	66116099	A4 - 11 taladros	10	60
20401212	66117099	A5 - 8 taladros	10	120

• Colores Pastel

Código	Ref.	Artículo	U/Vta	U/Emb
20401189	66114099	A4 - 11 taladros	10	60
20401190	66115099	A5 - 8 taladros	10	120



Recambio Ingeniox 50h extraíbles de 100g



• A4 - 11 taladros

Código	Ref.	Artículo	U/Vta	U/Emb
25401603	66104205	Liso	20	20
25401602	66104105	Cuadrícula 5x5	1	20
25401601	66104005	Horizontal	25	20
25401660	66104305	Dots	20	20

• A5 - 8 taladros

Código	Ref.	Artículo	U/Vta	U/Emb
25401606	66105205	Liso	1	25
25401605	66105105	Cuadrícula 5x5	1	25
25401604	66105005	Horizontal	1	25
25401659	66105305	Dots	1	25



Sobre Ingeniox polipropileno transparente con cierre adherente

Código	Ref.	Artículo	U/Vta	U/Emb
18001859	66125001	A5	10	300
18001858	66124001	A4	10	200

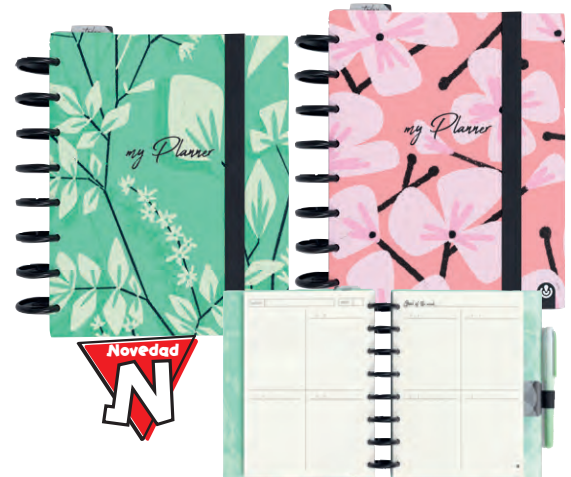

Bloc My Planner Ingeniox A5 240h S/V

Código	Ref.	Artículo	U/Vta	U/Emb
10003214	66035105	Rosa Sakura	1	8
10003215	66035106	Verde Shizen	1	8

Gama METAL



Carpeta de gomas y solapas Metal F° polipropileno Expositor de 30

Código	Ref.	U/Vta	U/Emb
10403819	20188800	1	1



Carpeta de fundas Archivex Metal A4 PP 30 fundas Con sobre de polipropileno 5 colores surtidos

Código	Ref.	U/Vta	U/Emb
15302816	53293099	10	10



Dossier sobre Metal cierre velcro PP Pack de 10

Código	Ref.	Artículo	U/Vta	U/Emb
18001931	34081099	F°	10	10
18001932	34084099	A5	10	10



Carpeta de anillas Metal A4 cartón plastificado brillo 4 anillas mixtas 5 colores surtidos

Código	Ref.	Anillas	U/Vta	U/Emb
10403820	12250499	25mm	10	10
10403821	12251499	40mm	8	8

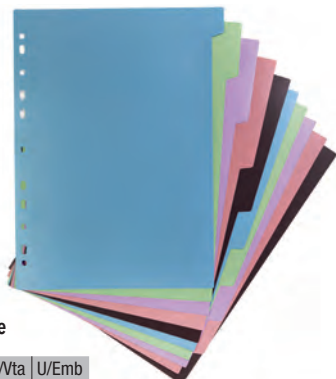

Separadores Metal A4 PP extrafuerte

Código	Ref.	Artículo	U/Vta	U/Emb
20401213	49080699	6 pestañas	10	40
20401214	49081099	10 pestañas	10	30



Carpebloc Metal A4 PP Foam 4 anillas mixtas de 35mm Recambio de 100h, cuadrícula 4x4 5 colores surtidos

Código	Ref.	U/Vta	U/Emb
10403822	12257499	8	8



Clasificador acordeón Metal F° PP 13 departamentos (A-Z) Ribete de tela a juego Expositor de 12

Código	Ref.	U/Vta	U/Emb
10301812	19288800	1	1



Gama
SOFT



Carpeta de gomas y solapas Soft F° polipropileno
Expositor de 30

Código	Ref.	U/Vta	U/Emb
10403813	20168700	1	1



Contenido Expositor:
6x 532620 20 fundas
5x 532630 30 fundas
5x 532640 40 fundas

Carpeta de fundas Archivex Soft PP A4 30 fundas
Con sobre de polipropileno

Código	Ref.	Artículo	U/Vta	U/Emb
15302230	53263099	5 colores surtidos	10	10
15302237	53268800	Expositor de 16	1	1



APERTURA 360°
CON SOBRE DE POLIPROPILENO
DE CIERRE ADHERENTE Y 4
SEPARADORES DE PP EXTRA RÍGIDO
COLORES PASTEL



Carpebloc Soft A4 polipropileno Foam
4 anillas mixtas de 35mm
Recambio de 100h 90g, cuadrícula 5x5

Código	Ref.	Color	U/Vta	U/Emb
10403629	12467410	Azul	4	8
10403630	12467414	Malva	4	8
10403631	12467417	Menta	4	8
10403632	12467421	Verde	4	8
10403633	12467425	Rosa	4	8
10403563	12467499	Surtido	8	8



Separadores Soft A4 PP extrafuerte

Código	Ref.	Artículo	U/Vta	U/Emb
20401168	49060699	6 pestañas	10	40
20401188	49061099	10 pestañas	10	30



Clasificador acordeón Soft F° PP
13 departamentos (A-Z)
Ribete de tela a juego
Expositor de 12

Código	Ref.	U/Vta	U/Emb
10301811	19268700	1	1



Carpebloc Soft A4 cartón forrado
4 anillas mixtas de 35mm
Recambio de 100h, cuadrícula 5x5
5 colores surtidos

Código	Ref.	U/Vta	U/Emb
10403560	12247499	4	8



Dossier sobre Soft polipropileno opaco cierre velcro
5 colores surtidos

Código	Ref.	Artículo	U/Vta	U/Emb
18001835	34061099	F°	10	30
18001836	34064099	A5	10	30



Gama GRADIENT

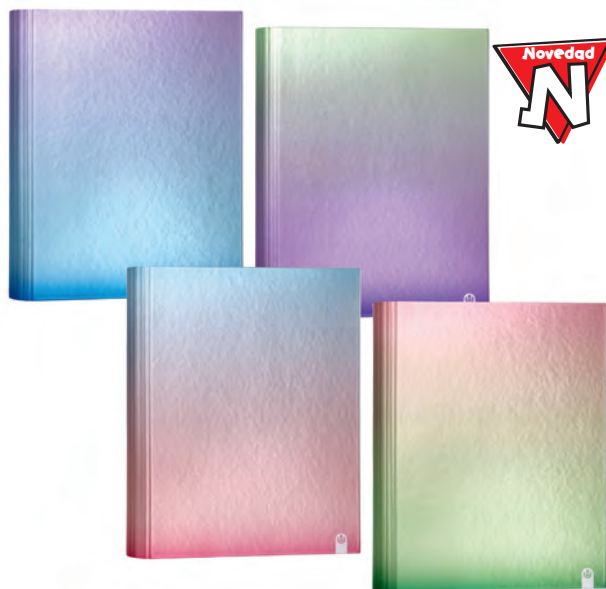

Bloc Gradient A5 80h 90g cuadrícula tapa forrada

Código	Ref.	Color	U/Vta	U/Emb
10003269	64705130	Azul - Coral	8	8
10003270	64705131	Violeta - Azul	8	8
10003271	64705132	Coral - Verde	8	8
10003272	64705133	Verde - Violeta	8	8
10003273	64705199	Surtido	8	8



Carpeta de anillas Gradient A4 cartón plastificado brillo 4 anillas mixtas 5 colores surtidos

Código	Ref.	Anillas	U/Vta	U/Emb
10404239	12260499	25mm	10	10
10404244	12261499	40mm	8	8

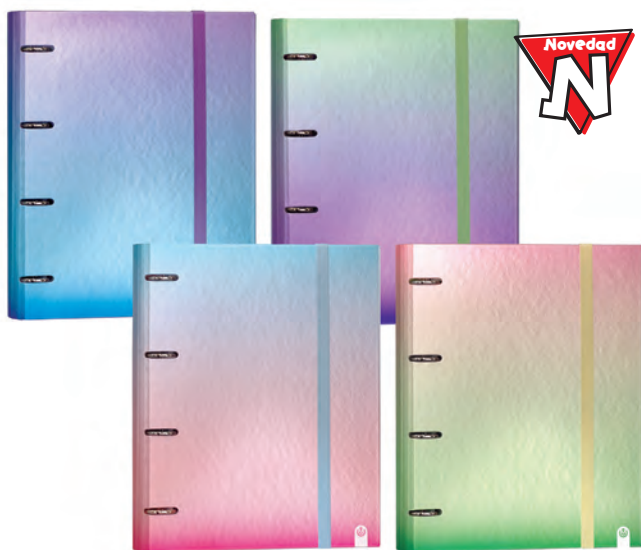

Racambio Bonus A4 100h 90g cuadrícula 5x5 4 taladros

Código	Ref.	U/Vta	U/Emb
25401667	65410499	1	8



Carpebloc Gradient F° tapa extradura 4 anillas mixtas de 35mm Recambio de 100h, cuadrícula 5x5 4 colores surtidos

CON RECAMBIO BONUS
CON HOJAS ORGANIZACIÓN
PERSONAL PARA EL ESTUDIANTE

Código	Ref.	U/Vta	U/Emb
10403988	12267499	1	8



Dossier sobre Eva con cremallera textil con tirador Etiqueta individual con colgador para estantería de pincho Colores surtidos

Código	Ref.	Artículo	U/Vta	U/Emb
18001797	45011099	A4	12	36
18001798	45012099	A5	12	72
18001799	45013099	Check	12	72
18001800	45014099	A6	12	72



Sobre PP A4 cierre velcro

Código	Ref.	Color	U/Vta	U/Emb
18002051	9F105V57-3	Azul	12	60
18002052	9F105V57-6	Violeta	12	60
18002053	9F105V57-5	Verde	12	60
18002054	9F105V57-4	Naranja	12	60
18002055	9F105V57-20	Rosa	12	60
18002056	9F105V57-1	Amarillo	12	60



Dossier sobre A4 polipropileno con broche

Código	Ref.	Color	U/Vta	U/Emb
18001212	9F105-1	Amarillo	12	60
18001213	9F105-2	Rojo	12	60
18001214	9F105-3	Azul	12	60
18001215	9F105-5	Verde	12	60
18001216	9F105-90	Fume	12	60
18001193	9F105-00	Cristal	12	60
18001440	9F105-4	Naranja	12	60
18001441	9F105-6	Violeta	12	60



Clasificadores, 12 Departamentos. Transparente rayado, etiquetas, visores y cierre con doble botón. Perfil de tela en color negro.

Código	Ref.	Color	U/Vta	U/Emb
10301222	9FKBA4-12-0	Cristal	1	12
10301300	9FKBA4-12-2	Rojo	2	12
10301301	9FKBA4-12-3	Azul	2	12
10301302	9FKBA4-12-5	Verde	1	12



Clasificadores PP opaco, 12 departamentos etiquetas, visores y cierre con goma elástica - Perfil tela en color negro

Código	Ref.	Color	U/Vta	U/Emb
10301220	9FKA4-12-2	Rojo	1	12
10301221	9FKA4-12-3	Azul	1	12



Clasificador acordeón PP Plata opaco 12 Departamentos ribete y gomas

Código	Ref.	U/Vta	U/Emb
10301324	9FKA4-12T	1	6





Dossier sobre cremallera PVC
Pack de 8

Código	Ref.	Medida	Color	U/Vta	U/Emb
18001843	509001	A4	Azul	1	5
18001844	509021	A5	Azul	1	5
18001845	509061	A6	Azul	1	5
18001846	509041	250x130mm	Azul	1	5
18001816	509009	A4	Surtido	1	40
18001817	509029	A5	Surtido	1	40
18001818	509069	A6	Surtido	1	40
18001819	509049	250x115mm	Surtido	1	40
18001809	510257	Expositor 32	4 col. surtidos	1	1



Dossier sobre Color collection PP
Expositor surtido de 84

Código	Ref.	U/Vta	U/Emb
18001808	510256	1	1



Funda adhesiva con marco Magneto A4,
vertical/horizontal
Pack de 2

Código	Ref.	Artículo	U/Vta	U/Emb
19807004	194950	Gris	1	1
19807006	194951	Azul	1	1
19807007	194953	Rojo	1	1
19807041	194957	Negro	1	1



Dossier sobre PP Color Dream
Expositor de 20

Código	Ref.	U/Vta	U/Emb
18001807	510225	1	1



Arandela adhesiva Ø13 transparentes

Código	Ref.	Artículo	U/Vta	U/Emb
13301017	8214-250	Pack de 250	1	20
13301018	8214-500	Pack de 500	1	20

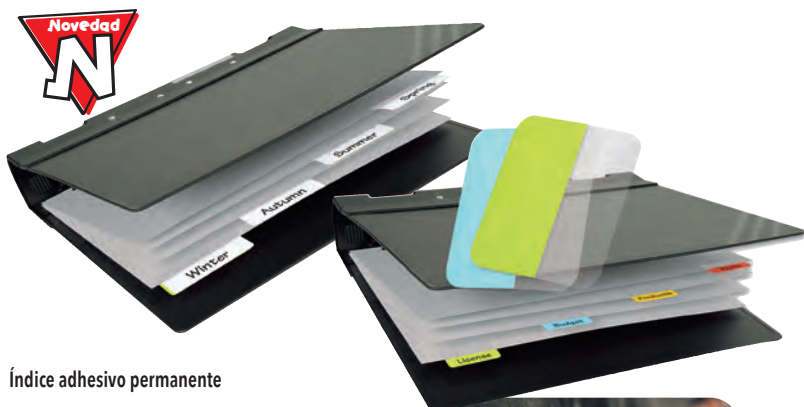

Índice adhesivo permanente

• **Blanco**

Código	Ref.	Artículo	Tamaño	U/Vta	U/Emb
20401159	10513	Bolsa de 48	12 x 40 mm	1	10
20401102	10511	Bolsa de 72	12 x 25mm	1	10

• **Surtido**

Código	Ref.	Artículo	Tamaño	U/Vta	U/Emb
20401225	10512	Bolsa de 48	12 x 40 mm	1	10
20401224	10510	Bolsa de 72	12 x 25mm	1	10



Tira adhesiva multiladrol

Código	Ref.	Tamaño	Artículo	U/Vta	U/Emb
19801696	8802-25	A5	Pack de 25	1	5
19801697	8804-10	A4	Pack de 10	1	10
19801698	8804-100	A4	Pack de 100	1	5



Clasificador cartón forrado

Código	Ref.	Formato	Color	U/Vta	U/Emb
10301587	100580256	Folio		1	12



Carpeta de anillas cartón forrado

Código	Ref.	Formato	Anillas	Color	U/Vta	U/Emb
10402410	100580211	Folio	2x25 mm		12	12
10402412	100580212	Folio	2x40 mm		12	12
10402478	100580218	Folio	4x40 mm		12	12
10402499	100580206	4°	4x20 mm		10	10



Archivador rado Top lomo 80 mm

• A4

Código	Ref.	Color	U/Vta	U/Emb
11601589	100202148		1	10
11601590	100202157		1	10
11601591	100202156		1	10
11601253	100202154		10	10
11601762	100025937		20	10
11601764	100025943		20	10



• FOLIO

Código	Ref.	Color	U/Vta	U/Emb
11601573	100023201		1	10
11601574	100023202		1	10
11601575	100023203		1	10
11601600	100023205		1	10
11601761	400084922		10	10
11601756	400085036		10	10
11601758	400085038		10	10
11601759	400085039		1	10
11601760	400085080		1	10

Exterior de plástico,
interior en papel



ARCHIVA Y
PROTEGE

Fundas multitaladro PP calidad Standard

Código	Ref.	Tamaño	Taladro	Descripción	U/Vta	U/Emb
19801091	400005365	F°	16	90µ piel naranja	100	100
19801185	400005366	F°	16	70µ cristal	100	100
19801335	400005371	A4	11	70µ cristal	100	100



ORGANIZA
Y DIVIDE

Carpeta de anillas F° cartón cuero forrado, color marrón

Código	Ref.	Anillas	U/Vta	U/Emb
10417146	100580220	2x40 mm	1	10



Taco de notas encolado blanco 10x10 cm

Código	Ref.	U/Vta	U/Emb
26901006	T-148	1	60



Fichas rayadas. Paquete de 100

Código	Ref.	Artículo	U/Vta	U/Emb
19301021	F-1	rayada 65x95mm - Nº1	1	210
19301017	F-2	rayada 75x125mm - Nº2	1	140
19301015	F-3	rayada 100x150mm - Nº3	1	80
19301016	F-4	rayada 125x200mm - Nº4	1	50
19301025	F-5	rayada 160x215mm - Nº5	1	40

Fichas lisas. Paquete de 100

Código	Ref.	Artículo	U/Vta	U/Emb
19301020	F-1	lisa 65x95mm - Nº1	1	210
19301022	F-2	lisa 75x125mm - Nº2	1	140
19301014	F-3	lisa 100x150mm - Nº3	1	80
19301023	F-4	lisa 125x200mm - Nº4	1	50
19301024	F-5	lisa 160x215mm - Nº5	1	40

Talonario Facturas

Código	Ref.	Artículo	U/Vta	U/Emb
27001090	T-6	4º Natural	10	120
27001091	T-63	4º Nat Dupli	10	120
27001092	T-65	4º Nat Tripli	5	80
27001095	T-68	8º Nat Dupli	10	240
27001094	T-46	8º Natural	10	240
27001097	T-56	Fº Nat Dupli	10	60
27001096	T-43	Fº Natural	10	60



Talonario Presupuesto Natural Duplicado

Código	Ref.	Artículo	U/Vta	U/Emb
27001108	T-90	4º	10	120
27001109	T-96	A4	10	60



Talonario Llamadas 8º Natural

Código	Ref.	U/Vta	U/Emb
27001101	T-62	10	240



Talonario Entregas apaisado

Código	Ref.	Artículo	U/Vta	U/Emb
27001079	T-26	4º	10	120
27001081	T-49	4º Duplicado	10	120
27001080	T-47	4º Triplicado	5	80
27001084	T-32	8º	10	240
27001086	T-79	8º Duplicado	10	240

Talonario Pedidos

Código	Ref.	Artículo	U/Vta	U/Emb
27001104	T-71	4º Natural Duplicado	10	120
27001103	T-27	4º Natural	10	120
27001107	T-97	Holandesa Duplicado	10	60
27001106	T-30	Holandesa	10	60



Talonario Camareros

Código	Ref.	Artículo	U/Vta	U/Emb
27001077	T-140	De bolsillo duplicado	10	330
27001075	T-58	8º Natural	10	240
27001074	T-88	8º Duplicado	10	240
27001076	T-89	8º Triplicado	5	160



Talonario de Recibos tamaño 1/3 folio

Código	Ref.	Artículo	U/Vta	U/Emb
27001111	T-60	Duplicado	10	180
27001110	T-16	Normal	10	180

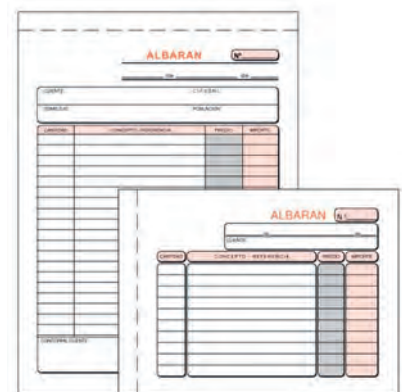

Talonario Albaranes

Código	Ref.	Artículo	U/Vta	U/Emb
27001067	T-118	4º Natural	10	120
27001068	T-120	4º Natu. Dupli	10	120
27001117	T-122	4º Natu. Tripli	5	80
27001161	T-119	4º Apdo. Dupli	10	120
27001118	T-121	4º Apdo. Tripli	5	80
27001069	T-123	8º Apdo. Dupli	10	240



Dossier Clip Duraclip® 30 PVC A4 2200 pinza metal 30h



Dossier Clip Duraclip® 60 PVC A4 2209 pinza metal 60h



Dossier Clip Swingclip® PP A4 2260 pinza opaca pivotante opaco 30h

Código	Ref.	Artículo	U/Vta	U/Emb
18001007	220001	Negro	25	25
18001025	220002	Blanco	25	25
18001032	220003	Rojo	25	25
18001028	220004	Amarillo	25	25
18001031	220005	Verde Claro	25	25
18001024	220006	Azul Claro	25	25
18001030	220007	Azul Oscuro	25	25
18001029	220010	Gris	25	25
18001026	220031	Burdeos	25	25
18001027	220032	Verde Oscuro	25	25
18001457	220028	Azul Antracita	25	25
18001458	220057	Gris Antracita	25	25

Código	Ref.	Artículo	U/Vta	U/Emb
18001034	220901	Negro	25	25
18001039	220902	Blanco	25	25
18001040	220903	Rojo	25	25
18001041	220904	Amarillo	25	25
18001033	220905	Verde Claro	25	25
18001035	220906	Azul Claro	25	25
18001037	220907	Azul Oscuro	25	25
18001045	220910	Gris	25	25
18001459	220928	Azul Antracita	25	25
18001036	220931	Burdeos	25	25
18001038	220932	Verde Oscuro	25	25
18001460	220957	Gris Antracita	25	25

Código	Ref.	Artículo	U/Vta	U/Emb
18001160	226001	Negro	25	25
18001461	226002	Blanco	25	25
18001462	226003	Rojo	25	25
18001463	226004	Amarillo	25	25
18001464	226005	Verde	25	25
18001466	226006	TransL. Azul	25	25
18001465	226007	Azul Oscuro	25	25

Expositor Duraclip de 70 unidades 10 uds de color negro, blanco, rojo, verde amarillo, azul claro, azul oscuro



Código	Ref.	U/Vta	U/Emb
18001888	999111694	1	1

Expositores Swingclip®

Código	Ref.	Expositor	U/Vta	U/Emb
18001103	2261	30 uds	1	1
18001889	999111695	48 uds	1	1



Dossier Clip Duraswing PP A4 pinza plástico (30 hojas). Bolsa de 5

Código	Ref.	U/Vta	U/Emb
18001665	230400	1	1



Dossier fástener 2690 transparente "Clear View" Expositor de 70

Código	Ref.	U/Vta	U/Emb
18001890	999111584	1	1

- 10x negro
- 10x blanco
- 10x rojo
- 10x azul oscuro
- 5x amarillo
- 5x verde
- 5x azul claro
- 5x naranja
- 5x lila
- 5x rosa oscuro



Dossier fástener Duraplus A4 2579 Expositor de 90

Código	Ref.	U/Vta	U/Emb
18001887	999111696	1	1

- 10x negro
- 10x rojo
- 10x amarillo
- 10x verde
- 10x azul claro
- 10x azul oscuro
- 10x gris
- 20x blanco



Pinza magnética Durafix® Roll 5m x 17mm negro

Código	Ref.	U/Vta	U/Emb
24301087	470801	1	1



Pinza magnética negra Durafix® Rail. Bolsa de 5

Código	Ref.	Artículo	U/Vta	U/Emb
24301084	470501	60x17mm	1	1
24301085	470601	210x17mm	1	1
24301086	470701	297x17mm	1	1



Marco magnetico Duraframe® negro autoadhesivo Bolsa de 2

Código	Ref.	Tamaño	U/Vta	U/Emb
24301033	487001	A6	1	1
24301034	487101	A5	1	1
24307551	487201	A4	1	1
24301035	487301	A3	1	1



Carpeta pvc escolar F° 4 Anillas - 25 mm Fun Color Expositor de 12

Código	Ref.	U/Vta	U/Emb
10417419	505FC-90	1	2



Carpeta F° 4 anillas mixtas y miniclip con cierre con pasador diseño color mix

Código	Ref.	Anillas	U/Vta	U/Emb
10405023	515CFC-90	25mm	1	20
10405022	514CFC-90	40mm	1	24



Carpeta Solapas y gomas pvc F° Fun Color Expositor de 18

Código	Ref.	U/Vta	U/Emb
10417420	343FC-90	1	2



Carpeta Canguro A4, 4 Anillas, Fun Color Colores Surtidos

Código	Ref.	Anillas	U/Vta	U/Emb
10417434	8425FCM490	25mm	6	36
10403511	8440FCM490	40mm	6	24



Block de notas Fun color 100h con cierre de goma. 9,5x14,5 cm

Código	Ref.	U/Vta	U/Emb
10001226	405FC90	1	26



Carpebloc Neón traslúcido A4 4 anillas de 25mm Recambio de 120 hojas 90gr Colores surtidos

Código	Ref.	U/Vta	U/Emb
10403994	524NE90	6	12



Carpebloc Fun Color personalizable A4 4 anillas vista 25mm Recambio de 120 hojas 90gr 6 colores

Código	Ref.	U/Vta	U/Emb
10410025	524FC90	6	12

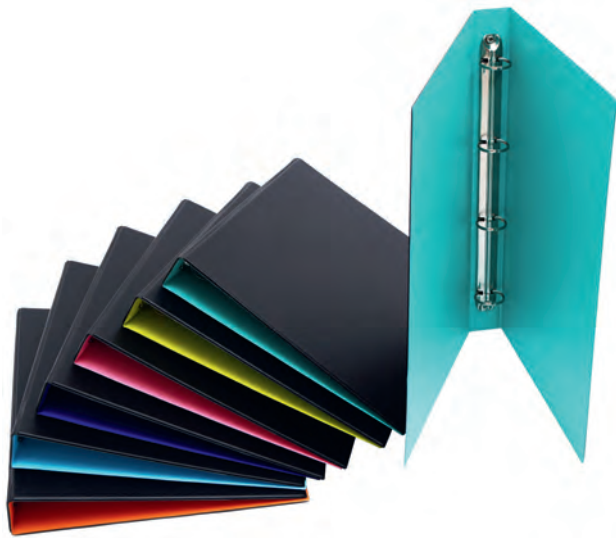

Carpeta de anillas Color Classic F° 4 anillas mixtas 25mm
Expositor surtido de 12

Código	Ref.	U/Vta	U/Emb
10403344	505CC	1	2



Vade canguro sobremesa Fun Color personalizable
Colores surtidos

Código	Ref.	U/Vta	U/Emb
14201239	481FCC	6	6



Bloc de notas Nature Bambú ecológica
80 hojas

Código	Ref.	U/Vta	U/Emb
10002920	406BA	5	5



Bloc de notas Nature Corcho ecológica
80 hojas

Código	Ref.	U/Vta	U/Emb
10002921	406CO	5	5



Portatodo color fun surtido 20x7 cm

Código	Ref.	U/Vta	U/Emb
11301100	263CFC90	6	6



Forro ajustable adhesivo transparente 100µ

Código	Ref.	Descripción	U/Vta	U/Emb
11801255	869F29	29 x 53 cm	25	100
11801256	869F30	30 x 53 cm	25	100
11801244	869F315	31,5 x 53 cm - Expositor de 20	1	4



Expositor de goma eva líquida con 12 botes
6 escenas

Código	Ref.	U/Vta	U/Emb
25213027	085394	1	12

Gama COLOUR"BREEZE



Taladro 2 punzones Rapid FC5 (10h) Colour"Breeze

Código	Ref.	Color	U/Vta	U/Emb
13101172	5001533	Coral	1	20
13101173	5001534	Lavanda	1	20
13101135	5001332	Azul	1	20
13101136	5001331	Verde	1	20



Grapadora Rapid F4 (10h) Colour"Breeze

Código	Ref.	Color	U/Vta	U/Emb
12901392	5001531	Coral	6	20
12901393	5001532	Lavanda	6	20
12901394	5001327	Azul	6	20
12901395	5001326	Verde	6	20



Porta lápices Colour"Breeze

Código	Ref.	Color	U/Vta	U/Emb
30501080	628459	Coral	6	6
30501074	628460	Lavanda	6	6
30501081	626269	Azul	6	6
30501075	626270	Verde	6	6



Bandeja sobremesa Colour"Breeze

Código	Ref.	Color	U/Vta	U/Emb
14501134	628453	Coral	10	10
14501173	628454	Lavanda	10	10
14501135	626274	Azul	10	10
14501174	626275	Verde	10	10



Revistero plástico transparente Colour"Breeze

Código	Ref.	Color	U/Vta	U/Emb
22601114	628455	Coral	10	10
22601115	628456	Lavanda	10	10
22601062	626279	Azul	10	10
22601078	626280	Verde	10	10



Papelera Colour"Breeze translúcido 14L

Código	Ref.	Color	U/Vta	U/Emb
14401344	628461	Coral	12	12
14401325	628462	Lavanda	12	12
14401326	626289	Azul	12	12
14401345	626290	Verde	12	12



Modulo cajones Colour"Breeze 4 cajones

Código	Ref.	Color	U/Vta	U/Emb
14501171	628457	Coral	1	4
14501170	628458	Lavanda	1	4
14504055	626284	Azul	1	4
14501172	626285	Verde	1	4



Archivador de palanca Colour"Breeze A4 plástico forrado con rado 75mm

Código	Ref.	Color	U/Vta	U/Emb
11602027	628429	Coral	10	10
11602028	628430	Lavanda	10	10
11601887	626212	Azul	10	10
11601888	626213	Verde	10	10

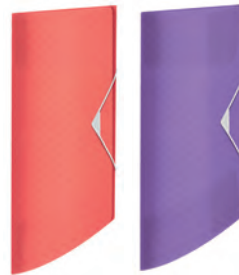

Carpeta de gomas y solapas Colour"Breeze A4 PP

Código	Ref.	Color	U/Vta	U/Emb
10403042	628439	Coral	4	20
10403043	628440	Lavanda	4	20
10403044	626222	Azul	4	20
10403045	626223	Verde	4	20



Clasificador acordeón Colour"Breeze A4 PP 6 separadores

Código	Ref.	Color	U/Vta	U/Emb
10301712	628447	Coral	3	6
10301711	628448	Lavanda	3	6
10301713	626252	Azul	3	6
10301714	626253	Verde	3	6



Carpeta de proyectos Colour"Breeze A4 PP gomas

Código	Ref.	Artículo	Color	U/Vta	U/Emb
10403062	628449	25 mm	Coral	2	12
10403063	628450	25 mm	Lavanda	2	12
10403064	626259	25 mm	Azul	2	12
10403065	626260	25 mm	Verde	2	12
10403066	628451	40 mm	Coral	5	8
10403067	628452	40 mm	Lavanda	5	8
10403068	626264	40 mm	Azul	5	8
10403069	626265	40 mm	Verde	5	8



Carpeta de fundas Colour"Breeze A4 PP flexible

Código	Ref.	Artículo	Color	U/Vta	U/Emb
15302487	628441	40 fundas	Coral	4	20
15302488	628442	40 fundas	Lavanda	4	20
15302489	626227	40 fundas	Azul	4	20
15302490	626228	40 fundas	Verde	4	20
15302491	628443	60 fundas	Coral	4	20
15302492	628444	60 fundas	Lavanda	4	20
15302493	626232	60 fundas	Azul	4	20
15302494	626233	60 fundas	Verde	4	20
15302495	628445	80 fundas	Coral	4	20
15302496	628446	80 fundas	Lavanda	4	20
15302497	626237	80 fundas	Azul	4	20
15302498	626238	80 fundas	Verde	4	20



Carpeta clasificadora Colour"Breeze A4 PP con goma

Código	Ref.	Artículo	U/Vta	U/Emb
10301696	626255	6 separadores	3	12
10301697	626256	12 separadores	3	12



Archivador Esselte plástico Forrado Lomo

Código	Ref.	Color	Lomo	U/Vta	U/Emb
11601160	42307	Azul	50 mm	1	240
11601083	42308	Negro	50 mm	1	240
11601159	42305	Rojo	50 mm	1	240
11601161	42306	Verde	50 mm	1	240
11601438	42324	Amarillo	75 mm	1	240
11601104	42303	Azul	75 mm	1	240
11601436	42322	Gris	75 mm	1	240
11601437	42323	Naranja	75 mm	1	240
11601107	42304	Negro	75 mm	1	240
11601012	42301	Rojo	75 mm	1	240
11601086	42302	Verde	75 mm	1	240



Carpeta Oficina F° Mixta, 2 anillas

Código	Ref.	Color	Artículo	U/Vta	U/Emb
10404026	62309	Negro	25mm	1	6
10404355	62306	Azul	25mm	1	6
10417331	62302	Rojo	25mm	1	6
10404189	13309	Negro	40mm	1	6
10404356	13306	Azul	40mm	1	6
10417332	13302	Rojo	40mm	1	6

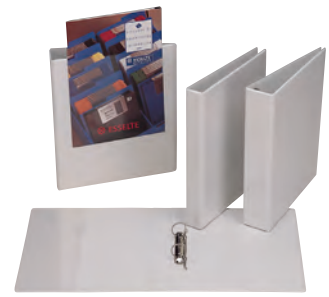

Carpeta A4 Anillas Canguro Básica Blanco

Código	Ref.	Artículo	U/Vta	U/Emb
10404829	49720	2 anillas - 16mm	1	10
10417327	49737	2 anillas - 25mm	1	10
10417328	49739	2 anillas - 40mm	1	10
10404341	49700	4 anillas - 16mm	1	10
10417329	49702	4 anillas - 25mm	1	10
10417330	49704	4 anillas - 40mm	1	10
10404736	49705	4 anillas - 50mm	1	10
10417315	49706	4 anillas - 60mm	1	10



Carpeta A4 de anillas canguro Plus

Código	Ref.	Artículo	U/Vta	U/Emb
10404209	55218	2anillas-25mm	1	10
10404210	55221	2anillas-40mm	1	10
10404213	55292	4anillas-25mm	1	10
10404220	55295	4anillas-40mm	1	10



Dossier Fastener PVC F°

Código	Ref.	Color	U/Vta	U/Emb
18001002	13206	Azul	50	250
18001012	13209	Negro	50	250
18001013	13203	Burdeos	50	250
18001014	13205	Verde	50	250
18001046	13202	Rojo	50	250
18001053	13216	Azul Marino	50	250



Fundas multitaladro polipropileno con refuerzo Paquete de 100

• *Piel de naranja*

Código	Ref.	Artículo	U/Vta	U/Emb
19801006	56133	A4 - 11 Tal. 40µ	1	1000
19801007	46114	F° - 16 Tal. 40µ	1	1000
19801110	46099	A4 - 16 Tal. 80µ	1	1000
19801084	46134	F° - 16 Tal. 80µ	1	1000
19801035	56200	F° - 16 Tal. 80µ*	10	100

*Bolsa de 10

• *Cristal liso*

Código	Ref.	Artículo	U/Vta	U/Emb
19801264	46108	A4 - 11 Tal. 80µ	1	1000
19801232	46106	F° - 16 Tal. 80µ	1	1000

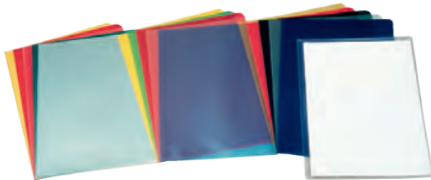

Dossier transparente ángulo recto F° Paquete de 100

Código	Ref.	Producto	Textura	U/Vta	U/Emb
18001009	46015	PP 110µ	Piel Nar.	1	10
18001055	46024	PVC 140µ	Liso	1	5

Índice numérico A4+ PP 11 taladros imprimible

Código	Ref.	Pestañas	U/Vta	U/Emb
26201032	100211	1-5	1	20
26201033	100212	1-6	1	20
26201034	100213	1-10	1	10
26201035	100214	1-12	1	10

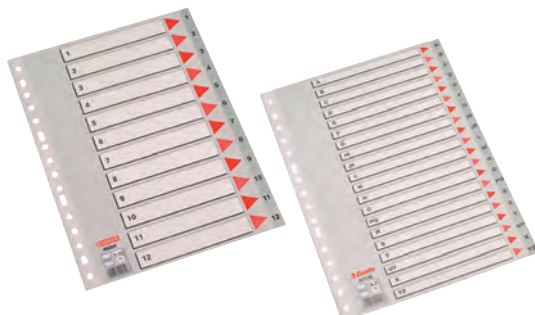

Índice gris multitaladro F° PP con taladros. Índice color.

Código	Ref.	Formato	Índice	U/Vta	U/Emb
20401036	47138	20 pestañas	Alfabético	1	10
20401018	49205	1-12 pestañas	Numérico	1	10
20401019	49206	1-31 pestañas	Numérico	1	10



Índice A4 cartulina Mylar borrable numérico 11 taladros

Código	Ref.	Pestañas	U/Vta	U/Emb
26201036	100207	1-5	1	20
26201037	100208	1-10	1	10
26201038	100209	1-12	1	10
26201039	100210	1-31	1	10



Índice alfabético 20 pestañas PP gris

Código	Ref.	Artículo	U/Vta	U/Emb
20401014	47139	F° - 16 taladros	1	36
20401005	100112	A4 - 11 taladros	1	10

Separador multitaladro

Código	Ref.	Artículo	Taladros	U/Vta	U/Emb
26201000	11609	F° - 5 pest.	16	1	100
26201001	11709	A4 - 5 pest.	11	1	100
26201007	11610	F° - 10 pest.	16	1	50
26201043	11710	A4 - 10 pest.	11	1	50

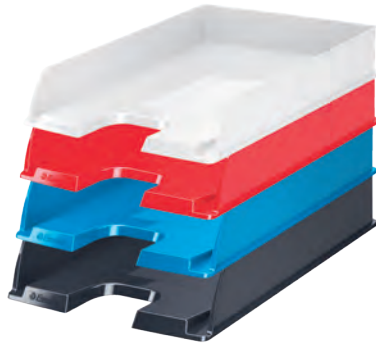

Bandeja Europost Sobremesa Colores VIVIDA Opacos

Código	Ref.	Color	U/Vta	U/Emb
14501073	623605	Negro	10	270
14501071	623606	Azul Oscuro	10	270
14501069	623607	Rojo	10	270
14501074	623608	Blanco	10	270
14501070	623609	Gris	10	270



Bandeja Europost Sobremesa Colores VIVIDA transparentes

Código	Ref.	Color	U/Vta	U/Emb
14501058	623603	Cristal	10	270
14501051	623604	Fume	10	270
14501376	623597	Verde	10	270
14501068	623600	Azul Oscuro	10	270
14501220	623601	Rojo	10	270



Revistero Plástico Europost 72mm

Código	Ref.	Color	U/Vta	U/Emb
11604018	21433	Cristal transparente	1	320
11604019	21434	Fume transparente	10	320
11604022	623935	Rojo opaco	1	320
11604024	21439	Azul opaco	1	320
11604025	21440	Negro opaco	1	320

Gama WOW



Archivador Leitz Wow A4 180° 80mm metalizado

Código	Ref.	Color	U/Vta	U/Emb
11601883	10050101	Blanco	10	10
11601877	10050123	Fucsia	10	10
11601878	10050136	Azul	10	10
11601879	10050116	Amarillo	10	10
11602574	10050154	Verde	10	10
11602575	10050151	Turquesa	10	10
11601882	10050162	Violeta	10	10



Revistero plástico Wow A4 60mm metalizado

Código	Ref.	Color	U/Vta	U/Emb
22601040	52771023	Fucsia	6	180
22601041	52771036	Azul	6	180
22601042	52771016	Amarillo	6	180
22601043	52771054	Verde	6	180
22601044	52771051	Turquesa	6	180
22601045	52771062	Violeta	6	180
22601046	52772199	Surtido	6	180



Bandeja sobremesa Wow metalizado

Código	Ref.	Color	U/Vta	U/Emb
14501363	52263023	Fucsia	5	135
14501365	52263036	Azul	5	135
14501353	52263016	Amarillo	5	135
14501364	52263054	Verde	5	135
14501389	52263051	Turquesa	5	135
14501390	52263062	Violeta	5	135
14501392	52264199	Surtido	10	180



Bandeja sobremesa Wow Dual

Código	Ref.	Color	U/Vta	U/Emb
14501322	53611001	Blanco/Gris	1	4
14501324	53611016	Blanco/Amarillo	1	4
14501103	53611023	Blanco/Fucsia	1	4
14501104	53611036	Blanco/Azul	1	4
14501105	53611054	Blanco/Verde	1	4
14501326	53611051	Blanco/Turquesa	1	4
14501329	53611062	Blanco/Violeta	1	4
14501352	53611095	Blanco/Negro	1	4



Revistero Wow Dual

Código	Ref.	Color	U/Vta	U/Emb
22601081	53621001	Blanco/Gris	1	4
22601082	53621016	Blanco/Amarillo	1	4
22601074	53621023	Blanco/Fucsia	1	4
22601083	53621036	Blanco/Azul	1	4
22601085	53621054	Blanco/Verde	1	4
22601084	53621051	Blanco/Turquesa	1	4
22601086	53621062	Blanco/Violeta	1	4
22601087	53621095	Blanco/Negro	1	4



Papelerera Recycle 15L negro

Código	Ref.	U/Vta	U/Emb
14401391	53280095	1	6



Bandeja sobremesa Recycle negro

Código	Ref.	U/Vta	U/Emb
14501452	53240095	1	6



Revistero plástico Recycle A4 70mm opaco negro

Código	Ref.	U/Vta	U/Emb
22601103	53260095	1	6



Archivador de palanca Recycle A4 180° negro
De cartón 100% reciclado, climáticamente neutro, 100% reciclable y certificado por FSC y por Blue Angel.

Código	Ref.	Artículo	U/Vta	U/Emb
11601966	10190095	50mm	10	10
11601965	10180095	80mm	10	10



Funda multitaladro Recycle gran capacidad A4 100µ Piel de naranja polipropileno 11 taladros Bolsa de 25

Código	Ref.	Artículo	U/Vta	U/Emb
19801608	47913103	A4	1	1
19801609	40210003	A4+	1	1



Funda multitaladro A4 polipropileno reciclado piel de naranja, 11 taladros reforzados

Código	Ref.	Artículo	Bolsa	U/Vta	U/Emb
19801522	627501	100µ	50 uds	1	10
19801622	627493	70µ	100 uds	1	10



Dossier uñero Recycle A4 polipropileno transparente Paquete de 25

Código	Ref.	U/Vta	U/Emb
18001821	40013103	1	1



Archivador palanca CO2 Neutral N°1 A4 cartón forrado 75mm

Código	Ref.	Artículo	U/Vta	U/Emb
11602029	627565	Azul	10	10
11602030	627566	Amarillo	10	10
11602031	627567	Verde	10	10
11602032	627568	Rojo	10	10
11602033	627569	Negro	10	10
11602034	627570	Blanco	10	10

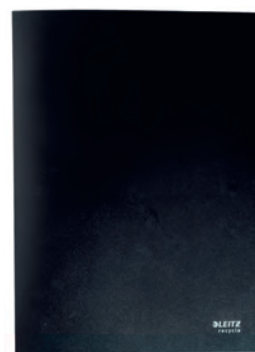

Carpeta de fundas Recycle A4 PP flexible negro 90% de plástico reciclado, climáticamente neutros y 100% reciclables.

Código	Ref.	Artículo	U/Vta	U/Emb
15302700	46760095	20 fundas	10	10
15302701	46770095	40 fundas	10	10



Carpeta de proyectos Recycle A4 PP botón 3cm negro

Código	Ref.	U/Vta	U/Emb
10408637	46230095	5	5



Clasificador acordeón A4 PP Recycle 6+1 separadores, negro

Código	Ref.	U/Vta	U/Emb
10417405	46240095	5	5



Carpeta de gomas y 3 solapas Recycle A4 polipropileno negro

Código	Ref.	U/Vta	U/Emb
10403531	46220095	10	10

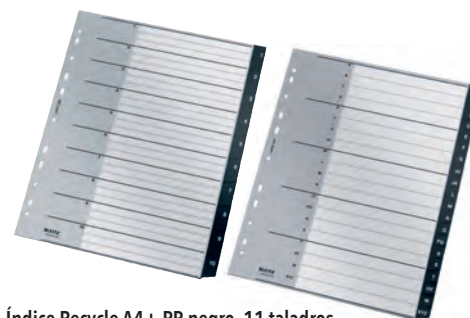

Índice Recycle A4+ PP negro, 11 taladros

Código	Ref.	Artículo	U/Vta	U/Emb
20401178	12080000	Numérico (1-10 pestañas)	10	10
20401179	12090000	Numérico (1-12 pestañas)	10	10
20401180	12110000	Numérico (1-20 pestañas)	10	10
20401181	12180000	Numérico (1-31 pestañas)	10	10
20401182	12190000	A-Z (1-20 pestañas)	20	20

Gama COSY



10 AÑOS GARANTÍA

Grapadora Petrus Cosy gris (30h)

Código	Ref.	U/Vta	U/Emb
12901451	627473	1	6



10 AÑOS GARANTÍA

Taladro Petrus Cosy gris 2 punzones (30h)

Código	Ref.	U/Vta	U/Emb
13101170	627474	1	6



Portarrollos Cosy 33m

Código	Ref.	Color	U/Vta	U/Emb
16601067	53670019	Amarillo	1	4
16601068	53670061	Azul	1	4
16601069	53670089	Gris	1	4



Botella isotérmica Cosy 500ml

Código	Ref.	Color	U/Vta	U/Emb
15801036	90160019	Amarillo	1	1
15801037	90160061	Azul	1	1
15801038	90160089	Gris	1	1



Bandeja sobremesa Cosy

• 1 bandeja

Código	Ref.	Color	U/Vta	U/Emb
14501440	53580019	Amarillo	1	6
14501441	53580061	Azul	1	6
14501442	53580089	Gris	1	6

• 2 bandejas

Código	Ref.	Color	U/Vta	U/Emb
14501443	53581019	Amarillo	1	1
14501444	53581061	Azul	1	1
14501445	53581089	Gris	1	1

• 3 bandejas

Código	Ref.	Color	U/Vta	U/Emb
14501449	53582019	Amarillo	1	1
14501450	53582061	Azul	1	1
14501451	53582089	Gris	1	1



Módulo Cosy 2 cajones

Código	Ref.	Color	U/Vta	U/Emb
14501453	53570019	Amarillo	1	1
14501454	53570061	Azul	1	1
14501455	53570089	Gris	1	1



Caja de almacenamiento Cosy portátil

Código	Ref.	Color	U/Vta	U/Emb
29701131	61250019	Amarillo	1	1
29701132	61250061	Azul	1	1
29701133	61250089	Gris	1	1

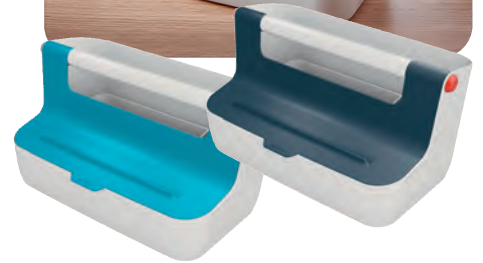

Carpeta fundas Cosy Plus A4 PP flexible con 3 solapas y cierre con goma
20 fundas

Código	Ref.	Color	U/Vta	U/Emb
15302702	46700019	Amarillo	10	10
15302703	46700061	Azul	10	10
15302704	46700089	Gris	10	10



Dossier sobre (privacidad) Cosy A4 PP cierre con broche, opaco con dos bolsillos

Código	Ref.	Color	U/Vta	U/Emb
18001828	47090019	Amarillo	12	12
18001829	47090061	Azul	12	12
18001830	47090089	Gris	12	12



Pizarra de cristal magnético Cosy

• 45x45cm

Código	Ref.	Color	U/Vta	U/Emb
23801795	70440019	Amarillo	1	1
23801796	70440061	Azul	1	1
23801797	70440089	Gris	1	1

• 60x40cm

Código	Ref.	Color	U/Vta	U/Emb
23801798	70420019	Amarillo	1	1
23801799	70420061	Azul	1	1
23801800	70420089	Gris	1	1

• 80x60cm

Código	Ref.	Color	U/Vta	U/Emb
23801801	70430019	Amarillo	1	1
23801802	70430061	Azul	1	1
23801803	70430089	Gris	1	1



Archivador de palanca Active Cosy Polyfoam A4 180° 82mm

Código	Ref.	Color	U/Vta	U/Emb
11601967	10380019	Amarillo	6	6
11601968	10380061	Azul	6	6
11601969	10380089	Gris	6	6



Carpeta de gomas y 3 solapas Cosy A4 cartón

Código	Ref.	Color	U/Vta	U/Emb
10403528	30020019	Amarillo	10	10
10403529	30020061	Azul	10	10
10403530	30020089	Gris	10	10



Portatodo Urban Chic

Código	Ref.	Color	U/Vta	U/Emb
11301901	60130020	Rojo	1	10
11301902	60130032	Azul	1	10
11301903	60130050	Verde	1	10
11301904	60130088	Gris	1	10



Carpeta de gomas y 3 solapas Urban Chic A4 PP

Código	Ref.	Color	U/Vta	U/Emb
10403564	46490020	Rojo	10	10
10403565	46490032	Azul	10	10
10403566	46490050	Verde	10	10
10403567	46490088	Gris	10	10



Archivador palanca Urban Chic A4 Polyfoam 180°
Lomo de 82mm

Código	Ref.	Color	U/Vta	U/Emb
11601982	11160020	Rojo	5	5
11601983	11160032	Azul	5	5
11601984	11160050	Verde	5	5
11601985	11160088	Gris	5	5



Carpeta de proyectos Urban Chic A4 PP cierre con gomas
Lomo 25mm

Código	Ref.	Color	U/Vta	U/Emb
10403568	39480020	Rojo	5	5
10403569	39480032	Azul	5	5
10403570	39480050	Verde	5	5
10403571	39480088	Gris	5	5



Clasificador acordeon Urban Chic A4 PP 6 separad.

Código	Ref.	Color	U/Vta	U/Emb
10301761	39970020	Rojo	5	5
10301762	39970032	Azul	5	5
10301763	39970050	Verde	5	5
10301764	39970088	Gris	5	5



Carpeta clasificadora Urban Chic A4 PP
con goma, 6 separadores

Código	Ref.	Color	U/Vta	U/Emb
10301765	39490020	Rojo	4	4
10301766	39490032	Azul	4	4
10301767	39490050	Verde	4	4
10301768	39490088	Gris	4	4



Carpeta de fundas Urban Chic A4 PP

Código	Ref.	Artículo	Color	U/Vta	U/Emb
15302726	46510020	20 fundas	Rojo	10	10
15302727	46510032	20 fundas	Azul	10	10
15302728	46510050	20 fundas	Verde	10	10
15302729	46510088	20 fundas	Gris	10	10
15302730	46140020	40 fundas	Rojo	10	10
15302731	46140032	40 fundas	Azul	10	10
15302732	46140050	40 fundas	Verde	10	10
15302733	46140088	40 fundas	Gris	10	10
15302734	46520020	80 fundas	Rojo	5	5
15302735	46520032	80 fundas	Azul	5	5
15302737	46520050	80 fundas	Verde	5	5
15302738	46520088	80 fundas	Gris	5	5



Grapadora 1600 para gruesos (100h)

Código	Ref.	U/Vta	U/Emb
12901000	44737	1	1



Grapadora metalizada 226 WOW (30h)

Código	Ref.	Color	U/Vta	U/Emb
12901333	626510	Fucsia	1	24
12901334	626511	Turquesa	1	24
12901417	626834	Amarillo	1	24
12901336	626513	Verde	1	24
12901337	626514	Ice blue	1	24
12901338	626515	Violeta	1	24
12901419	626833	Blanco	1	24
12901420	626835	Negro	1	24



Grapadora metálica 635 WOW (30h)

Código	Ref.	Color	U/Vta	U/Emb
12901872	623592	Fucsia	1	6
12901873	623593	Azul	1	6
12901416	626832	Amarillo	1	6
12901875	623595	Verde	1	6
12901929	624329	Turquesa	1	6
12901930	624330	Violeta	1	6
12901047	623375	Negro	1	6
12901871	623591	Blanco perla	1	6



Grapadora Rapid F16 (30h)

Código	Ref.	Color	U/Vta	U/Emb
12901862	23810501	Negro	1	20
12901863	23810502	Azul	1	20
12901864	23810503	Rojo	1	20



Grapadora metálica Petrus 226 clásica (30h)

Código	Ref.	Color	U/Vta	U/Emb
12901162	44794	Azul	1	24
12901163	44793	Rojo	1	24
12901164	44795	Gris/Plata	1	24
12901165	44844	Azul/Plata	1	24
12901179	44792	Negro	1	24



Grapadora metálica 635 (30h)

Código	Ref.	Color	U/Vta	U/Emb
12901222	623372	Rojo	1	30
12901223	623373	Azul	1	30



Grapadora 235 (30h)

Código	Ref.	Color	U/Vta	U/Emb
12901826	623368	Azul	1	30
12901828	623370	Negro	1	30
12901049	623367	Rojo	1	30



Grapadora metálica 2001 negro (30h)

Código	Ref.	Color	U/Vta	U/Emb
12901230	44786	Azul	1	24
12901020	44784	Negro	1	24
12901231	44787	Gris	1	24
12901229	44785	Rojo	1	24



Grapadora 435 Golf (30h)

Código	Ref.	Color	U/Vta	U/Emb
12901026	44715	Negro	1	24
12901224	44813	Rojo	1	24
12901225	44814	Gris	1	24
12901226	44815	Azul	1	24



Grapadora 236 grapado plano (30h)

Código	Ref.	Color	U/Vta	U/Emb
12901024	623379	Negro	1	30
12901218	623377	Azul	1	30
12901219	623376	Rojo	1	30



Grapadora Petrus 210 (25h)

Código	Ref.	Color	U/Vta	U/Emb
12901043	623366	Negro	1	12
12901220	623365	Azul	1	12
12901221	623364	Rojo	1	12



**Grapadora Liliput 200 (12h)
Una caja de grapas 23/6 incluida**

Código	Ref.	U/Vta	U/Emb
12901019	44743	10	100



**Grapadora Petrus Bambina 202 (5h)
Una caja de grapas 202 incluida**

Código	Ref.	U/Vta	U/Emb
12901021	44700	20	100



Grapadora Petrus WOW eléctrica E-310 metalizado (10h)
Alimentación 4 pilas de 1,5V (NO INCLUIDAS)

Código	Ref.	Color	U/Vta	U/Emb
12901086	624821	Fucsia	1	6
12901087	624822	Azul	1	6
12901418	626836	Amarillo	1	6
12901089	624826	Verde	1	6
12901103	624824	Turquesa	1	6
12901104	624825	Violeta	1	6



Grapadora Eléctrica Rapid 20EX (20h)
Adaptador de corriente incluido

Código	Ref.	U/Vta	U/Emb
12901213	5000297	1	12



Grapadora de tenaza 205 Majorete (10h)
Una caja de grapas 202 incluida

Código	Ref.	U/Vta	U/Emb
12901037	44730	12	12



Taladro metalizado 2 punzones 52 WOW (20h)

Código	Ref.	Color	U/Vta	U/Emb
13101109	626517	Fucsia	1	6
13101110	626518	Azul	1	6
13101145	626829	Amarillo	1	6
13101112	626520	Verde	1	6
13101113	626521	Turquesa	1	6
13101114	626522	Violeta	1	6
13101146	626828	Blanco	1	6
13101147	626830	Negro	1	6



Taladro metálico 52 pintado 2 punzones (20h)
Colores clásicos

Código	Ref.	Color	U/Vta	U/Emb
13101010	33707	Negro	1	24
13101230	33744	Azul	1	24
13101231	33746	Rojo	1	24
13101232	337610	Gris/Plata	1	24
13101234	33759	Azul/Plata	1	24



Taladros metalizado 2 punzones WOW 62 (30h)

Código	Ref.	Color	U/Vta	U/Emb
13101310	623587	Fucsia	1	6
13101311	623588	Azul	1	6
13101144	626831	Amarillo	1	6
13101313	623590	Verde	1	6
13102019	624327	Turquesa	1	6
13102020	624328	Violeta	1	6
13101309	623586	Blanco	1	6
13101016	623356	Negro	1	6



Taladro 95 Negro 2 punzones (40h)

Código	Ref.	U/Vta	U/Emb
13101008	623357	1	18



Taladro 80 Pintado 2 punzones (16h)

Código	Ref.	Color	U/Vta	U/Emb
13101007	623347	Negro	1	30
13101240	623345	Rojo	1	30
13101241	623346	Azul	1	30



Taladro 85 Pintado 2 punzones (25h)

Código	Ref.	Color	U/Vta	U/Emb
13101284	623348	Rojo	1	30
13101285	623349	Azul	1	30
13101286	623351	Negro	1	30



Taladro 50 Pintado Surtidos (10h)

Código	Ref.	U/Vta	U/Emb
13101003	623343	1	24



Taladro 4 punzones 72 Gris (16h)

Código	Ref.	U/Vta	U/Emb
13101005	623359	1	12



Taladro 4 punzones 405 Gris (25h)

Código	Ref.	U/Vta	U/Emb
13101021	623360	1	12



Taladro 305 Plata 2 punzones (65h)

Código	Ref.	U/Vta	U/Emb
13101035	623358	1	8



Plastificadora Foton 30 A4/A3 automática
Cargar los documentos en la bandeja de alimentación automática, pulsar el botón de inicio y dejar que plastifique automáticamente. Para oficinas con necesidades intensivas de plastificación. Ahorra el 98% del tiempo.



Código	Ref.	U/Vta	U/Emb
19201099	4410011	1	1

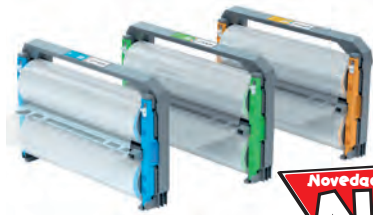

Film Foton brillo

Código	Ref.	Artículo	U/Vta	U/Emb
19201134	4410023	75µ	1	1
19201136	4410024	100µ	1	1
19201135	4410025	125µ	1	1

• **Recambios**

Código	Ref.	Artículo	U/Vta	U/Emb
19201137	4410026	75µ	1	1
19201139	4410027	100µ	1	1
19201138	4410028	125µ	1	1



Plastificadora Leitz iLam Office Pro A3 Plata/blanco

Código	Ref.	U/Vta	U/Emb
19201111	75180084	1	1



Plastificadora térmica Inspire+
Uso doméstico y profesional ocasional. De uso sencillo, con un interruptor y emplea carteras de 2x80 micras.

Código	Ref.	Artículo	U/Vta	U/Emb
19201053	4402076EU	A3	1	2
19201054	4402075EU	A4	1	2



Plastificadora térmica Fusion 3000L
Elegante y compacta. Lista para su uso en 1 minuto y plastifica un documento individual en 30 segundos, empleando fundas de 2 x 75/80 a 2 x 125 micras.

Código	Ref.	Artículo	U/Vta	U/Emb
21701142	4400749EU	A3	1	2
21701141	4400748EU	A4	1	2



Plastificadora térmica Fusion 3100LA3
Elegante y compacta, lista para su uso en un minuto. Plastifica hasta tamaño A3 en aprx. 20 segundos, utiliza fundas de 2 x 75/80 a 2 x 175 micras.

Código	Ref.	U/Vta	U/Emb
21701143	4400750EU	1	2



Plastificadora térmica Fusion Plus 6000LA3
Profesional y productiva. Sensores de entrada inteligentes que detectan el grosor de la funda y el contenido y ajustan automáticamente la velocidad. Plastifica fundas de 2x75 hasta 2x250 micras.

Código	Ref.	U/Vta	U/Emb
21701144	4402134EU	1	2



Cizalla de rodillo Leitz Precision Home A4

Código	Ref.	U/Vta	U/Emb
11701070	90250000	1	1

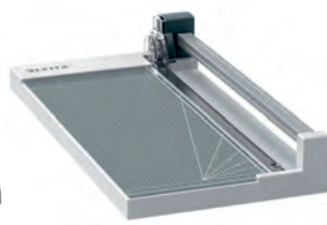

Cizalla de rodillo Leitz Precision Home Office A4+

Código	Ref.	U/Vta	U/Emb
11701072	90270000	1	1

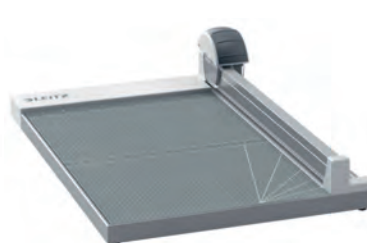

Cizalla de rodillo Leitz Precision Office

Código	Ref.	Artículo	U/Vta	U/Emb
11701071	90260000	A4+	1	2
11701073	90280000	A3	1	2



Cizalla de palanca Leitz Office

Código	Ref.	Artículo	U/Vta	U/Emb
11701077	90210000	A4+	1	1
11701084	90220000	A3	1	1



Encuadradora de canutillo C150PRO
Perfora hasta 20 hojas A4 de 80g y encuaderna hasta 450 hojas. Con bandeja de recortes de gran capacidad.

Código	Ref.	U/Vta	U/Emb
18104065	IB271106	1	1



Encuadradora de espiral MC10
Perfora hasta 10 hojas A4 de 80g y encuaderna hasta 450 hojas. Distancia de los agujeros 5:1.

Código	Ref.	U/Vta	U/Emb
18104093	4400556	1	2



Encuadradora de espiral Coilbind P59
Perfora hasta 15 hojas A4 de 80g y encuaderna hasta 450 hojas. Distancia de los agujeros 5:1.

Código	Ref.	U/Vta	U/Emb
18104070	IB277009	1	1



Destructora automática Optimum Autofeed 130X
Destruye hasta 130h 80g A4 en partículas de 4x28mm. Nivel de seguridad 4. Papelera 44L. 30 minutos de tiempo de funcionamiento.

Código	Ref.	U/Vta	U/Emb
16401287	2020130XEU	1	1



Destructora automática Optimum Autofeed 225X
Destruye hasta 225h 80g A4 en partículas de 4x25mm. Nivel de seguridad 4. Papelera 60L. 30 minutos de tiempo de funcionamiento.

Código	Ref.	U/Vta	U/Emb
16401232	2020225XEU	1	1



Destructora automática Optimum Autofeed 300X
Destruye hasta 300h 80g A4 en partículas de 4x25mm. Nivel de seguridad 4. Papelera 60L. 60 minutos de tiempo de funcionamiento.

Código	Ref.	U/Vta	U/Emb
16401196	2020300XEU	1	1



Destructora Secure X6 negro
Destruye 6h 80g A4 en partículas de 4x40mm. Nivel de seguridad 4. Papelera de 10L. 3 minutos de funcionamiento continuo.

Código	Ref.	U/Vta	U/Emb
16401402	2020122EU	1	1



Destructora Secure X8 negro
Destruye 8h 80g A4 en partículas de 4x40mm. Nivel de seguridad 4. Papelera de 14L. 3 minutos de funcionamiento continuo.

Código	Ref.	U/Vta	U/Emb
16401403	2020123EU	1	1



Destructora Secure X10 negro
Destruye 10h 80g A4 en partículas de 4x40mm. Nivel de seguridad 4. Papelera de 18L. 3 minutos de funcionamiento continuo.

Código	Ref.	U/Vta	U/Emb
16401404	2020124EU	1	1



Destructora Secure MC3 negro
Destruye 3h 80g A4 en micro corte de 2x15mm. Nivel de seguridad 5. Papelera de 10L. 6 minutos de funcionamiento continuo.

Código	Ref.	U/Vta	U/Emb
16401408	2020128EU	1	1



Destructora Secure MC4 negro
Destruye 4h 80g A4 en micro corte de 2x15mm. Nivel de seguridad 5. Papelera de 14L. 6 minutos de funcionamiento continuo.

Código	Ref.	U/Vta	U/Emb
16401409	2020129EU	1	1



Destructora Secure MC6 negro
Destruye 6h 80g A4 en micro corte de 2x15mm. Nivel de seguridad 5. Papelera de 18L. 6 minutos de funcionamiento continuo.

Código	Ref.	U/Vta	U/Emb
16401410	2020130EU	1	1



Destructora Momentum X312
Destruye 12h en confeti en corte cruzado partículas 5x42mm. Nivel de seguridad 3. Papelera 23L. 6 minutos de tiempo de funcionamiento.

Código	Ref.	U/Vta	U/Emb
16401323	2104572EU	1	1



Destructora Momentum X410
Destruye 10h en confeti de 4x28mm. Nivel de seguridad 4. Papelera 23L. 6 minutos de tiempo de funcionamiento.

Código	Ref.	U/Vta	U/Emb
16401324	2104571EU	1	1



Destructora Momentum X415
Destruye 15h en confeti en tiras de 4mm. Nivel de seguridad 4. Papelera 23L. 2 horas de tiempo de funcionamiento.

Código	Ref.	U/Vta	U/Emb
16401316	2104576EU	1	1



Destructora Momentum X420
Destruye 20h en confeti de tiras 4mm. Nivel de seguridad 4. Papelera 30L. 4 horas de tiempo de funcionamiento.

Código	Ref.	U/Vta	U/Emb
16401318	2104578EU	1	1



Reposapiés Solesaver

Código	Ref.	U/Vta	U/Emb
25101105	56152	1	4



Reposapiés Solemate Smartfit

Código	Ref.	U/Vta	U/Emb
42101153	K50416EU	1	4



Reposapiés Solemassage

Código	Ref.	U/Vta	U/Emb
42101080	56155EU	1	4



Soporte Smartfit® Easy Riser™ gris para portátil con ventilación

Código	Ref.	U/Vta	U/Emb
42105098	60112	1	6



Elevador Smartfit® Easy Riser™ gris ventilación para portátil 14"

Código	Ref.	U/Vta	U/Emb
42101187	K50421EU	1	1



Auriculares Hi-Fi usb con micrófono

Código	Ref.	U/Vta	U/Emb
42501393	K97601WW	1	1



Teclado y ratón inalámbricos Pro Fit negro

Código	Ref.	U/Vta	U/Emb
42501245	K75230ES	1	4



Teclado Value Keyboard negro USB

Código	Ref.	U/Vta	U/Emb
42501133	1500109ES	1	5



Ratón óptico retráctil Pro Fit

Código	Ref.	U/Vta	U/Emb
42504088	K72339EU	1	5



Ratón Valumouse óptico negro

Código	Ref.	Artículo	U/Vta	U/Emb
42501137	K72392EU	Inalámbrico	1	5
42501134	K72110EU	Usb	1	5



Ratón óptico Usb negro

Código	Ref.	U/Vta	U/Emb
42504123	K72356EU	1	5



Ratón Sure Track Dual inalámbrico

Código	Ref.	Artículo	U/Vta	U/Emb
42501374	K75350WW	Azul	1	1
42501376	K75352WW	Rojo	1	1
42501377	K75353WW	Blanco	1	1



Reposamuñecas Ergosoft para ratón

Código	Ref.	Color	U/Vta	U/Emb
42101155	K52802WW	Negro	1	6
42101128	K50432EU	Gris	1	6



Alfombrilla reposamuñecas Ergosoft para ratón

Código	Ref.	Color	U/Vta	U/Emb
42101150	K52888EU	Negro	1	6
42101129	K50437EU	Gris	1	6



Alfombrilla reposamuñecas espuma para ratón

Código	Ref.	Color	U/Vta	U/Emb
42101121	62384	Negro	1	6
42101138	64271	Azul	1	6



Reposamuñecas con espuma para teclado

Código	Ref.	Color	U/Vta	U/Emb
42101120	62383	Negro	1	4
42101139	64270	Azul	1	4



Puntero-Presentador Powerpointer

Código	Ref.	U/Vta	U/Emb
25101028	K75241EU	1	5



Presentador con puntero láser rojo inalámbrico. 4 intuitivos botones: hacia delante y hacia atrás, además de la opción de pantalla a negro y para activar el puntero láser.

Código	Ref.	U/Vta	U/Emb
16904048	33374EU	1	5



Pizarra hogar magnética 36x36cm

Código	Ref.	Color	U/Vta	U/Emb
23801494	1903802	Blanco	1	8
23801495	1903774	Negro	1	8
23801492	1903803	Rosa	1	8
23801493	1903773	Verde	1	8



Pizarra hogar magnética 58,5x43cm blanca + accesorios (2 rotuladores, 4 imanes, almohadillas de montaje adhesivas y un borrador)

Código	Ref.	U/Vta	U/Emb
23801496	1903777	1	6



Pizarra doble uso 58,5x43 cm (organizador magnético mensual + corcho) Se suministra con un rotulador, imanes y almohadillas de montaje adhesivas

Código	Ref.	U/Vta	U/Emb
23801500	1903813	1	6



Pizarra Essence blanca melamina Marco de aluminio anodizado. Se suministra con una bandeja para rotuladores. Borrado fácil, uso ocasional.

Código	Ref.	Medida	U/Vta	U/Emb
23801534	1915269	60x45 cm	1	1
23801535	1915270	90x60 cm	1	1
23801536	1915271	120x90 cm	1	1
23801768	1915452	120x120 cm	1	1
23801537	1915207	150x100 cm	1	1
23801769	1915208	150x120 cm	1	1
23801538	1915486	180x120 cm	1	1
23801539	1915223	240x120 cm	1	1



Pizarra Essence blanca magnética acero vitrificado Marco de aluminio anodizado. Bandeja de rotuladores. La superficies esmaltada ofrece un nivel superior de borrrabilidad y durabilidad para un uso frecuente.

Código	Ref.	Medida	U/Vta	U/Emb
23801783	1915445	60x45 cm	1	1
23801784	1915451	90x60 cm	1	1
23801785	1915453	120x90 cm	1	1
23801786	1915475	150x100 cm	1	1
23801787	1915446	150x120 cm	1	1
23801788	1915447	180x120 cm	1	1
23801789	1915448	240x120 cm	1	1



Pizarra Essence blanca magnética de acero lacado Marco de aluminio anodizado. Con bandeja para rotuladores. La superficie de acero lacado ofrece un nivel de borrado para uso frecuente.

Código	Ref.	Medida	U/Vta	U/Emb
23801512	1905209	60x45 cm	1	1
23801513	1905210	90x60 cm	1	1
23801514	1905211	120x90 cm	1	1
23801515	1905212	150x100 cm	1	1
23801516	1905213	180x120 cm	1	1
23801517	1905214	240x120 cm	1	1

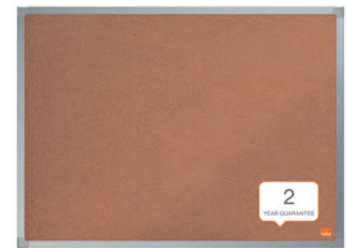

Tablero de corcho Essence marco de aluminio anodizado

Código	Ref.	Medida	U/Vta	U/Emb
23801774	1915460	60x45 cm	1	1
23801338	1903960	90x60 cm	1	1
23801497	1903961	120x90 cm	1	1
23801498	1903966	150x100 cm	1	1
23801775	1915209	150x120 cm	1	1
23801776	1903997	180x120 cm	1	1
23801777	1915347	200x100 cm	1	1
23801778	1915348	240x120 cm	1	1

Pizarra Classic de conferencia magnética lacada

Código	Ref.	Artículo	U/Vta	U/Emb
23801541	1902386	Móvil ruedas	1	1
23801489	1905243	Trípode	1	1
23801379	1901918	Trípode+brazos	1	1



Vitrina Premium Plus de interior, superficie magnética

Código	Ref.	Artículo	Descripción	U/Vta	U/Emb
23801557	1902557	4h x A4	Puerta abatible	1	1
23801558	1902560	9h x A4	Puerta abatible	1	1
23801381	1902570	12h x A4	Puerta corredera	1	1
23801504	1902571	18h x A4	Puerta corredera	1	1

Portapóster mural marco con clip Resistente a la intemperie, antirreflectante.

Código	Ref.	Medida	U/Vta	U/Emb
23801510	1902212	A2	1	1
23801383	1902213	A3	1	1
23801384	1902214	A4	1	1



Pantalla mural mate

Código	Ref.	Medida	U/Vta	U/Emb
16903061	1902392	1750x1325 mm	1	1
16903059	1902393	2000x1513 mm	1	1
16903056	1902394	2400x1813 mm	1	1



Purificador de aire Z-1000 EU

Código	Ref.	U/Vta	U/Emb
36901092	2415112EU	1	20



Purificador de aire Z-2000 EU

Código	Ref.	U/Vta	U/Emb
36901093	2415113EU	1	15



Purificador de aire Z-3000 EU

Código	Ref.	U/Vta	U/Emb
36901094	2415114EU	1	12



Filtro carbono para purificador de aire
Pack de 3

Capa de carbono activado, elimina ciertos gases y olores del aire.

Código	Ref.	Modelo	U/Vta	U/Emb
36901095	2415103	Z-1000 EU	1	6
36901098	2415106	Z-2000 EU	1	3
36901101	2415109	Z-3000 EU	1	3



Filtro Hepa para purificador de aire
Filtro de aire de partículas 2 en 1.

Código	Ref.	Modelo	U/Vta	U/Emb
36901096	2415104	Z-1000 EU	1	12
36901099	2415107	Z-2000 EU	1	12
36901140	2415143	Z-3000 EU	1	12



Bombilla UV para purificador de aire

Código	Ref.	Modelo	U/Vta	U/Emb
36901141	2415148	Z-1000 EU	1	20
36901142	2415149	Z-2000 EU	1	20
36901143	2415150	Z-3000 EU	1	20



Calculadora sobremesa

Código	Ref.	Artículo	U/Vta	U/Emb
15401267	IB410062	8 dígitos	1	20
15401268	IB410079	10 dígitos	1	20
15401375	IB410086	12 dígitos	1	20



Calculadora gráfica
TI-84 PLUS

Código	Ref.	U/Vta	U/Emb
15401602	5808430	1	3



Calculadora gráfic
a TI-84 Plus CE-T Python

Código	Ref.	U/Vta	U/Emb
15401603	5808441	1	3

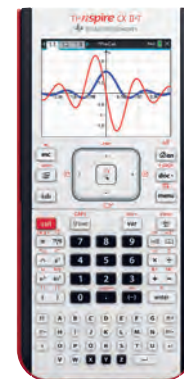

Calculadora gráfica
TI-NSPIRE CX II-T

Código	Ref.	U/Vta	U/Emb
15401604	5808840	1	6



Calculadora gráfica
TI-NSPIRE CX II-T CAS

Código	Ref.	U/Vta	U/Emb
15401605	5808740	1	6



Calculadora científica
TI-30XA

Código	Ref.	U/Vta	U/Emb
15401606	5803003	1	12



Calculadora científica
TI-30XB Multi View

Código	Ref.	U/Vta	U/Emb
15401607	5803004	1	12



Calculadora científica
TI-34 MultiView

Código	Ref.	U/Vta	U/Emb
15401608	5803405	1	12

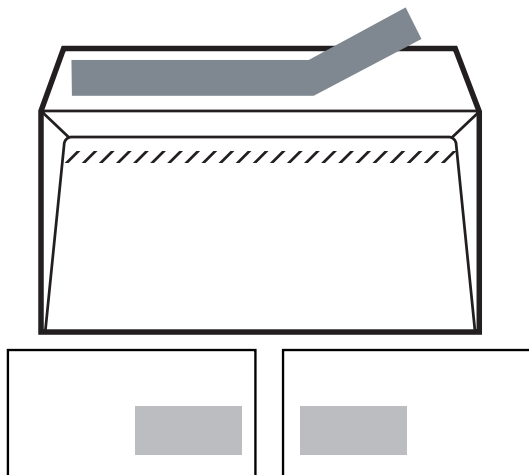

Sobres blancos. Caja de 500

Código	Ref.	Tamaño	Artículo	U/Vta	U/Emb
26401090	OPEN110	110x220mm	open silicona	1	8
26401001	OPEN110VD	110x220mm	open v. dcha. silicona	1	8
26401005	OPEN110VI	110x220mm	open v. izda. silicona	1	8
26401063	OPEN115	115x225mm	open silicona	1	8
26401061	OPEN115VD	115x225mm	open v. dcha. silicona	1	8
26401464	OPEN115VDLASER	115x225mm	open v. dcha. silicona esp. láser	1	8
26401470	OPEN115VI	115x225mm	open v. izda. silicona	1	8
26401064	OPEN176	120x176mm	open silicona	1	10
26401342	A-160230	162x229mm	open silicona	1	6
26401019	PQ.10 OPEN 110	110x220mm	open silicona paquete 10	50	8
26401022	PQ.10 OPEN 176	120x176mm	open silicona paquete 10	50	10

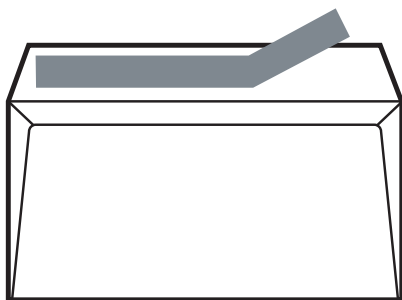

Sobres silicona

Código	Ref.	Artículo	Caja	U/Vta	U/Emb
26401033	A-17495	176x231mm 90g	500	1	6
26401086	A-18495	190x250mm 90g	250	1	8
26401083	A-C4/B	229x324mm 100g	250	1	6
26401320	A-25395	250x353mm 100g	250	1	6
26401017	A-40495	260x360mm 100g	250	1	6

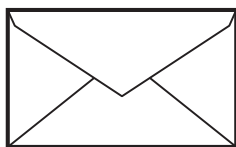

Sobre para tarjetas de visita 70x105mm Caja de 100

Código	Ref.	U/Vta	U/Emb
26401010	3793	1	100

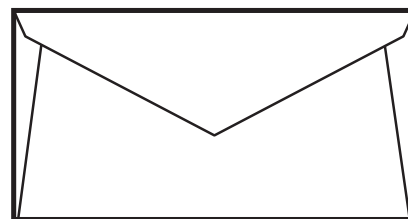

Sobres engomados

Código	Ref.	Tamaño	Artículo	Caja	U/Vta	U/Emb
26401049	9014	90x140mm	Blanco 80g	500	1	16
26401024	914/6	90x140mm	Caña verjurado 70g	1000	1	10
26401045	12176/6	120x176mm	Caña verjurado 70g	500	1	18



Sobre bolsa burbuja blanco Paquete de 10

Código	Ref.	Tamaño	U/Vta	U/Emb
26401550	AK-11 Blanco /146170	Nº11 - 100x165mm	1	20
26401551	AK-12 Blanco /146171	Nº12 - 120x215mm	1	20
26401571	AK-13 Blanco /146172	Nº13 - 150x215mm	1	20
26401572	AK-14 Blanco /146173	Nº14 - 180x265mm	1	10
26401573	AK-15 Blanco /146174	Nº15 - 220x265mm	1	20
26401574	AK-16 Blanco /146175	Nº16 - 220x340mm	1	10
26401575	AK-17 Blanco /146176	Nº17 - 240x340mm	1	20
26401576	AK-18 Blanco /146177	Nº18 - 270x360mm	1	10
26401577	AK-19 Blanco /146178	Nº19 - 300x445mm	1	20
26401578	AK-20 Blanco /146179	Nº20 - 340x470mm	1	5
26401579	AK-CD Blanco /146180	Nº21 - 180x165mm	1	20



Sobre bolsa burbuja kraft Paquete de 10

Código	Ref.	Tamaño	U/Vta	U/Emb
26401084	AK-11/10181100	Nº11 - 100x165mm	1	20
26401079	AK-12/10181200	Nº12 - 120x215mm	1	20
26401080	AK-13/10181300	Nº13 - 150x215mm	1	10
26401130	AK-14/10181400	Nº14 - 180x265mm	1	10
26401057	AK-15/10181500	Nº15 - 220x265mm	1	10
26401129	AK-16/10181600	Nº16 - 220x340mm	1	10
26401044	AK-17/10181700	Nº17 - 240x340mm	1	10
26401128	AK-18/10181800	Nº18 - 270x360mm	1	10
26401081	AK-19/10181900	Nº19 - 300x445mm	1	5
26401185	AK-20/10182000	Nº20 - 340x470mm	1	5
26401014	AK-CD/10182100	Nº21 - 180x165mm	1	10



Plastificadora

Código	Ref.	Artículo	U/Vta	U/Emb
21702050	0102P46LM	A2	1	1
21702027	0102P34LM	A3	1	1



Máquina de plastificar CR-A3

Código	Ref.	U/Vta	U/Emb
21702342	0102PCRA3	1	1



Funda plastificar
Paquete de 100

Código	Ref.	Artículo	U/Vta	U/Emb
19201058	0101DIN25	216x303 (A4) 125µ	1	100
19201059	0101DOF01	303x426 (A3) 125µ	1	100
19201060	0101DIN4	216x303 (A4) 80µ	1	100
19201061	0101DOF0	303x426 (A3) 80µ	1	100

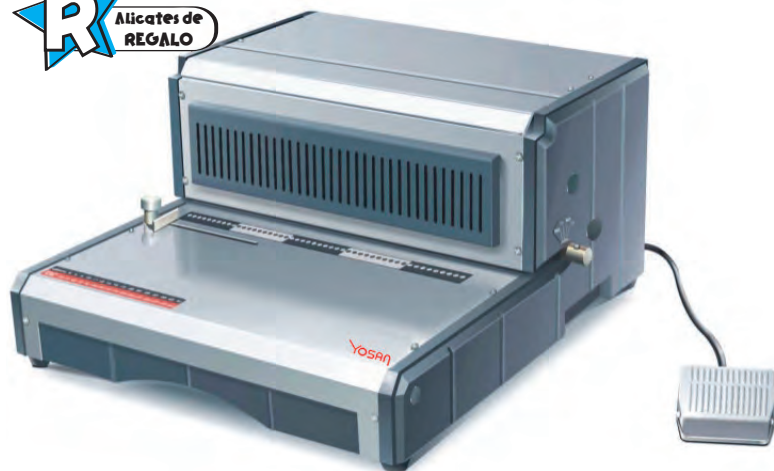

Encuadernadora espiral P164 paso 5:1

Código	Ref.	U/Vta	U/Emb
18104051	3036PE164	1	1



Encuadernadora manual espiral 64U
paso 5:1

Código	Ref.	U/Vta	U/Emb
18101081	3036PE64U	1	1



Máquina Encuadernar Espiral

Código	Ref.	Artículo	U/Vta	U/Emb
18104078	3036PERES	Modelo 56 - Paso 4:1	1	1
18104008	3036PER64	Modelo 64 - Paso 5:1	1	1



Alicate para cortar espiral.
Mango corto

Código	Ref.	U/Vta	U/Emb
18104011	0104ALES	1	1

Tapa de encuadernar cartón gofrado Flúor 0,9 mm
Paquete de 50

Código	Ref.	Artículo	U/Vta	U/Emb
18101092	0510GPFZ3	DIN A3 - Azul	1	1
18101093	0510GPFZD	DIN A4 - Azul	1	1
18101094	0510GPFAM3	DIN A3 - Amarillo	1	1
18101095	0510GPFAMD	DIN A4 - Amarillo	1	1
18101096	0510GPFRS3	DIN A3 - Rosa	1	1
18101097	0510GPFERSD	DIN A4 - Rosa	1	1
18101098	0510GPFNA3	DIN A3 - Naranja	1	1
18101099	0510GPFNAD	DIN A4 - Naranja	1	1
18101100	0510GPFVE3	DIN A3 - Verde	1	1
18101101	0510GPFVED	DIN A4 - Verde	1	1





Cizalla de palanca pisón automático

Modelo 35: Longitud de corte 380mm y capacidad 40h

Modelo 44: Longitud de corte 440mm y capacidad 40h

Modelo 56: Longitud de corte 560mm y capacidad 40h

Código	Ref.	Modelo	U/Vta	U/Emb
11701027	1520CIZ35	35	1	1
11702011	1520CIZ44	44	1	1
11701029	1520CIZ56	56	1	1



Cizalla de palanca

Modelo 33: Longitud de corte 330mm y capacidad 15h

Modelo 45: Longitud de corte 450mm y capacidad 15h

Código	Ref.	Modelo	U/Vta	U/Emb
11701036	1520CIZ33	33	1	1
11702058	1520CIZ45	45	1	1



Cortadora e insertadora de espiral

Código	Ref.	U/Vta	U/Emb
18101154	3036CORIN	1	1



Plegadora 7200 para A4/A5

Pliega hasta 3 hojas simultáneas en alimentación manual.

Pliega 1 hoja en automático.

Capacidad de 50 hojas en la bandeja.

Código	Ref.	U/Vta	U/Emb
18101176	5053P7200	1	1

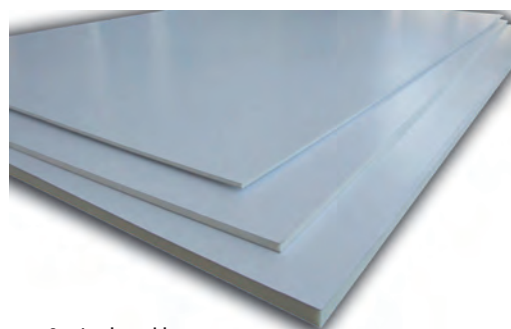

Cartón pluma blanco

• 3mm

Código	Ref.	Artículo	U/Vta	U/Emb
10701642	05223B50	50 x 70 cm	40	40
10701643	05223B70	70 x 100 cm	40	40
10701644	05223B14	140 x 100 cm	25	25
10701645	05223B20	200 x 100 cm	25	25
10701646	05223BA3	A3	40	40
10701647	05223BA4	A4	80	80

• 5mm

Código	Ref.	Artículo	U/Vta	U/Emb
10701648	05225B50	50 x 70 cm	25	25
10701649	05225B70	70 x 100 cm	25	25
10701650	05225B14	140 x 100 cm	25	25
10701651	05225B20	200 x 100 cm	25	25
10701652	05225BA3	A3	25	25
10701653	05225BA4	A4	50	50

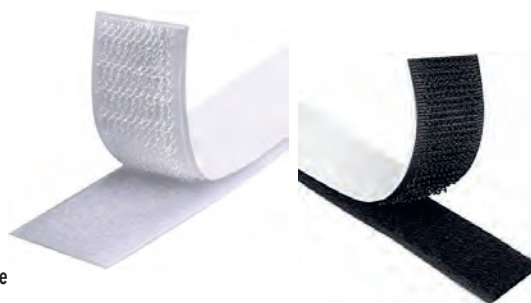

Cinta velcro bucle

• Blanco

Código	Ref.	Artículo	U/Vta	U/Emb
11901431	848CVAB16B	16mm x 25m	1	1
11901400	848CVAB20B	20mm x 25m	1	1
11901432	848CVAB25B	25mm x 25m	1	1
11901433	848CVAB30B	30mm x 25m	1	1
11901434	848CVAB50B	50mm x 25m	1	1

• Negro

Código	Ref.	Artículo	U/Vta	U/Emb
11901399	848CVAB16N	16mm x 25m	1	1
11901435	848CVAB20N	20mm x 25m	1	1
11901436	848CVAB25N	25mm x 25m	1	1
11901437	848CVAB30N	30mm x 25m	1	1
11901438	848CVAB50N	50mm x 25m	1	1

Cinta velcro gancho

• Blanco

Código	Ref.	Artículo	U/Vta	U/Emb
11901423	848CVAG16B	16mm x 25m	1	1
11901402	848CVAG20B	20mm x 25m	1	1
11901424	848CVAG25B	25mm x 25m	1	1
11901425	848CVAG30B	30mm x 25m	1	1
11901426	848CVAG50B	50mm x 25m	1	1

• Negro

Código	Ref.	Artículo	U/Vta	U/Emb
11901401	848CVAG16N	16mm x 25m	1	1
11901427	848CVAG20N	20mm x 25m	1	1
11901428	848CVAG25N	25mm x 25m	1	1
11901429	848CVAG30N	30mm x 25m	1	1
11901430	848CVAG50N	50mm x 25m	1	1





MINI CORTE



Destructora Automática Automax 80M

Destruye hasta 80 hojas de forma automática y 8 hojas de forma manual al mismo tiempo. Corte en minipartículas de 4x12 mm. Nivel de seguridad DIN P-4. Destruye grapas, clips y tarjetas de crédito.

Código	Ref.	U/Vta	U/Emb
16401456	4621501	1	1

MINI CORTE



Destructora Automática Automax 100M

Destruye hasta 100 hojas de forma automática y 10 hojas de forma manual en partículas de 4x10mm. Nivel de seguridad 4. Depósito de 23 litros. Destruye grapas, clips, tarjetas de crédito.

Código	Ref.	U/Vta	U/Emb
16401312	4629201	1	1



REPOSO AUTO REVERSE ULTRA SILENCIOSO **AUTO MÁTICA**

Destructora Automática Automax 150C

Destruye hasta 150 hojas automáticamente y 8 hojas manual. Corte en partículas de 4x38mm. Nivel de seguridad DIN P-4. Sistema anti-atasco Autoreverse.

Código	Ref.	U/Vta	U/Emb
16401249	4680101	1	1



MODO DE TRABAJO CONTINUO

SAFESENSE TECNOLOGÍA

100% ANTI-ATASCOS

AHORRO DE ENERGÍA

Destructora 225Ci

Destruye hasta 24 hojas en partículas de 4x38mm. Nivel de seguridad DIN P-4. Depósito de 60 litros. Destruye grapas, clips, tarjetas de crédito, Cds.

Código	Ref.	U/Vta	U/Emb
16401221	4622001	1	1



Destructora LX25 negra

Destruye hasta 6 hojas en partículas de 4x37mm. Nivel de seguridad DIN P-4. Depósito de 11,5 litros. Destruye grapas, clips y tarjetas de crédito

Código	Ref.	U/Vta	U/Emb
16401419	4170501	1	1



Destructora LX45 negra

Destruye hasta 8 hojas en partículas de 4x37mm. Nivel de seguridad DIN P-4. Depósito de 17 litros. Destruye grapas, clips y tarjetas.

Código	Ref.	U/Vta	U/Emb
16401391	4400501	1	1



SAFE SENSE TECNOLOGÍA

Destructora LX65 negra

Destruye hasta 10 hojas en partículas de 4x40mm. Nivel de seguridad DIN P-4. Depósito de 22 litros. Sistema de seguridad SafeSense de desconexión automática Destruye grapas, clips y tarjetas.

Código	Ref.	U/Vta	U/Emb
16401392	4400701	1	1



Destructora LX85 negra

Destruye hasta 12 hojas en partículas de 4x40mm. Nivel de seguridad DIN P-4. Depósito de 19 litros. Sistema de seguridad SafeSense de desconexión automática Destruye grapas, clips y tarjetas.

Código	Ref.	U/Vta	U/Emb
16401393	4400801	1	1



Destructora LX200 negra

Destruye hasta 12 hojas en minipartículas de 4x12mm. Nivel de seguridad DIN P-4. Depósito de 22 litros.

Código	Ref.	U/Vta	U/Emb
16401424	5502201	1	1



Easy-Press™

PROTECCIÓN QUE LLEVA A MICROBAN

Grapadora de tenaza LX890 40h

Código	Ref.	Color	U/Vta	U/Emb
12901551	5016601	Negro	1	1
12901552	5016501	Blanco	1	1



Bolsa para destructoras hasta 165L Paquete de 50

Código	Ref.	U/Vta	U/Emb
11401236	36055	1	1



Grapadora EasyPress Microban

Código	Ref.	Modelo	Grapa	Color	U/Vta	U/Emb
12901482	5011101	LX820	20h	Blanco	1	12
12901481	5012801	LX820	20h	Negro	1	12
12901480	5011701	LX840	25h	Blanco	1	12
12901479	5012901	LX840	25h	Negro	1	12
12901478	5011801	LX850	25h	Blanco	1	6
12901477	5013001	LX850	25h	Negro	1	6



Cizalla de rodillo Neutrino A5
Capacidad de corte hasta 5 hojas 80gr. Regla extensible, permite aumentar la base para formatos A4.

Código	Ref.	U/Vta	U/Emb
11702066	5412701	1	1



Cizalla de rodillo Neutron
Capacidad de corte hasta 10 hojas de 80gr. Barra compresora de papel ajustable. 4 tipos de cuchillas incluidas: corte recto, perforado, ondulado y plegado (solo en modelo A4 Plus)

Código	Ref.	Tamaño	U/Vta	U/Emb
11701038	5410001	A4	1	1
11702069	5410101	A4 Plus	1	1



Cizalla de rodillo Electron A3
Capacidad de corte hasta 10 hojas 80gr. 4 tipos de cuchillas incluidas: corte recto, perforado, ondulado y plegado. Sistema guía de luz LED, indica la línea de corte exacta.

Código	Ref.	U/Vta	U/Emb
11702050	5410501	1	1

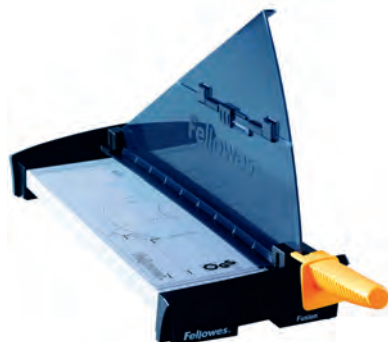

Cizalla de palanca Fusion

Capacidad máxima de hojas 10 (80 gr.) a la vez. Cuchilla de acero inoxidable. Longitud de corte: 320mm (A4) y 460mm (A3). Con guías de corte.

Código	Ref.	Tamaño	U/Vta	U/Emb
11702070	5410901	A3	1	1
11702074	5410801	A4	1	1



Cizalla de palanca Stellar

Capacidad máxima de hojas 20 (80 gr.) a la vez. Cuchilla de acero inoxidable. Longitud de corte: 305mm (A4) y 460mm (A3). Con guías de corte.

Código	Ref.	Tamaño	U/Vta	U/Emb
11701041	5438401	A3	1	1
11701040	5438001	A4	1	1

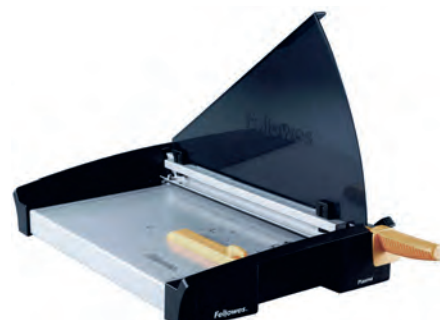

Cizalla de palanca Plasma

Capacidad máxima de hojas 40 (80 gr.) a la vez. Cuchilla de acero inoxidable. Longitud de corte: 380mm (A4) y 480mm (A3). Con guías de corte.

Código	Ref.	Tamaño	U/Vta	U/Emb
11702054	5411101	A3	1	1
11702063	5411001	A4	1	1



Plastificadora Lunar

Uso ocasional. Adecuada para fundas de plastificación de 80 a 125 micras. 2 rodillos. Tiempo de calentamiento 6 minutos.

Código	Ref.	Tamaño	U/Vta	U/Emb
21705007	5716701	A3	1	1
21705002	5715601	A4	1	1



Plastificadora Ion A4

Ideal para hogar y oficina en casa. Fundas de hasta 80-125 micras. Liberación de rodillos para evitar atascos. Apagado automático.

Código	Ref.	U/Vta	U/Emb
21701155	4560001	1	1



Plastificadora Saturn 3i

Fundas de hasta 125 micras. 2 rodillos de calor. Plástica en frío. InstaHeat: lista para usar en 60". Velocidad de plastificación de 30mm/min. Sistema de retroceso.

Código	Ref.	Tamaño	U/Vta	U/Emb
21702330	5736001	A3	1	2
21702323	5724801	A4	1	2



Plastificadora Spectra

Uso moderado. Adecuada para fundas de plastificación de 125 micras. 2 rodillos. Tiempo de calentamiento 4 minutos.

Código	Ref.	Tamaño	U/Vta	U/Emb
21702333	5738301	A3	1	1
21702332	5737801	A4	1	1



6 Tecnología Rodillos

Plastificadora Amaris A3

Ajuste de temperatura. Sistema de retroceso. Sensor de limpieza. Lista para usar en tan sólo 60 segundos. 6 rodillos. Para fundas de 80, 125 hasta 175 micras. Para un uso intensivo.

Código	Ref.	U/Vta	U/Emb
19201121	8058201	1	1



Plastificadora Jupiter A3

Ajuste automático que detecta el grosor de la funda. Lista para usar en 60 segundos. 6 rodillos. Plástica fundas de hasta 250 micras tamaño A4 en tan sólo 24 segundos (750mm/min). Sistema de retroceso. Sensor indicador de limpieza.

Código	Ref.	U/Vta	U/Emb
19201114	5748401	1	1



Plastificadora Neptune-3 A3

Ajuste automático que detecta el grosor de la funda. Plástica fundas de tamaño A4 en tan sólo 60 segundos (600mm/min). 4 rodillos. Plástica fundas de hasta 175 micras. Velocidad de plastificación 80cm/min. Sistema de retroceso.

Código	Ref.	U/Vta	U/Emb
21705004	5721501	1	2

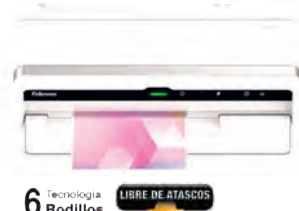

Maquina plastificar Venus A3

Ajuste automático que detecta el grosor de la funda. Tiempo de calentamiento: 30" para fundas de 80 micras y 60" para fundas restantes. Indicado Feed IQ, avisa cuando se puede introducir la siguiente funda. Plástica en frío. Apagado automático.

Código	Ref.	U/Vta	U/Emb
19201115	5746701	1	1



Metal 50

Encuadradora Metal espiral metálico. Perfora hasta 20 hojas (Metal 100) y 12 hojas (Metal 50) A4 de 80gr. Encuaderna hasta 450 hojas A4 de 80gr con un espiral de 50mm. Paso 5:1. Selector del diámetro del espiral. Regulación del margen lateral y de profundidad.

Código	Ref.	Artículo	U/Vta	U/Emb
18101083	3005001	Metal 50	1	2
18101167	0030102	Metal 100	1	2



Metal 100



Encuadradora Lyra multifunción 3 en 1

Encuadradora multifunción de canutillo de plástico, encuaderna, grapa y perfora 2 y 4 orificios. Guía lateral ajustable A4/A5. Bandeja de residuos. Grapadora para 30h. Perfora hasta 20h de 80g. Encuaderna hasta 300h.

Código	Ref.	U/Vta	U/Emb
18101234	5603101	1	1



Soporte para portátil Office Suites 17" o 5kg Ajustable a alturas: 11,23 - 17,2 cm. Ángulo ajustable hasta 14 - 27,5°.

Código	Ref.	U/Vta	U/Emb
42105111	8032001	1	2



Soporte monitor giratorio Tft/Lcd La plataforma gira 45°. Soporta pantallas de hasta 14kg. Ajuste en alturas 9, 10,5 y 12cm. Tamaño de la plataforma 42,5 x 28,5cm.

Código	Ref.	U/Vta	U/Emb
42105030	91450	1	2



Soporte CPU metálico con ruedas grafito Ajustable entre 152 a 229mm. Acero resistente con acolchado para proteger la CPU. Cuatro ruedas, dos con bloqueo.

Código	Ref.	U/Vta	U/Emb
42105113	9169201	1	2



Soporte CPU ajustable con ruedas. Soporta hasta 50kg. 4 ruedas, 2 con freno. Ancho ajustable de 7 a 28 cm.

Código	Ref.	U/Vta	U/Emb
42105071	8039001	1	1



Reposapiés ajustable ergonómico Tamaño superficie 42,5 x 30cm. Ajustable a alturas 8,5 - 10,5 cm. Ángulo de inclinación hasta 25°.

Código	Ref.	U/Vta	U/Emb
42106011	48121-70	1	2



PROTECTION THAT LIVES ON MICROBAN® Reposapiés ajustable Tamaño superficie 44,5 x 33,4 cm. Ajustable a alturas 10,8 - 12,7 - 14,6 cm. Ángulo de inclinación hasta 30°.

Código	Ref.	U/Vta	U/Emb
42106013	8035001	1	2



Soporte lumbar Mesh Material de malla que permite la circulación del aire. Sistema triple tensor que pone el respaldo en su posición.

Código	Ref.	U/Vta	U/Emb
42105108	9191301	1	2



CASITA DE CARTÓN PARA PINTAR Y DECORAR

Casita de cartón para pintar Personaliza tu casita de juegos con bolígrafos y pinturas de colores (no incluidos). Fácil montaje en 2 piezas sin necesidad de cinta adhesiva o pegamento. Dimensiones casa montada: 121,3 x 96,5 x 81,3cm.

Código	Ref.	Artículo	U/Vta	U/Emb
29701168	1232401	Unicornios	1	1
29701169	1232501	Pastelería	1	1



12 dígitos

Calculadora de bolsillo SHC-312
12 dígitos

Código	Ref.	Color	U/Vta	U/Emb
15401527	RE-SHC312BL	Azul	1	160
15401525	RE-SHC312BK	Negro	1	160
15401526	RE-SHC312RD	Rojo	1	160



10 dígitos

Calculadora sobremesa Ergo 10
10 dígitos

Código	Ref.	U/Vta	U/Emb
15401547	RE-Ergo 10	1	2



12 dígitos

Calculadora sobremesa CC512 BX
12 dígitos

Código	Ref.	U/Vta	U/Emb
15401548	RE-CC512	1	2



12 dígitos

Calculadora sobremesa SDC412
12 dígitos

Código	Ref.	U/Vta	U/Emb
15401546	RE-SDC412	1	2



12 dígitos

Calculadora sobremesa SDC-912
12 dígitos

Código	Ref.	Color	U/Vta	U/Emb
15401529	RE-SDC912	Azul	1	1
15401531	RE-SDC912OR	Naranja	1	1
15401532	RE-SDC912PK	Rosa	1	1
15401530	RE-SDC912GR	Verde	1	1



12 dígitos

Calculadora impresora PDC10 WB
12 dígitos

Código	Ref.	U/Vta	U/Emb
15401552	RE-PDC10	1	2



12 dígitos

Calculadora impresora PDC20 WB
12 dígitos

Código	Ref.	U/Vta	U/Emb
15401553	RE-PDC20	1	2



12 dígitos

Calculadora impresora PDC30 WB
12 dígitos

Código	Ref.	U/Vta	U/Emb
15401554	RE-PDC30	1	2



10 dígitos

Calculadora científica SC2030
10 dígitos

Código	Ref.	U/Vta	U/Emb
15401549	RE-SC2030	1	2



12 dígitos

Calculadora científica CS2080S
12 dígitos (2 líneas)

Código	Ref.	U/Vta	U/Emb
15401551	RE-SC2080S	1	2



12 dígitos

Calculadora científica SC2040
12 dígitos (2 líneas)

Código	Ref.	U/Vta	U/Emb
15401550	RE-SC2040	1	2



Calculadora de sobremesa 10 dígitos

Código	Ref.	Color	U/Vta	U/Emb
15401511	SH-ELM332 BBL	Azul	1	60
15401513	SH-ELM332 BPK	Rosa	1	60



Calculadora de sobremesa EL-M335 10 dígitos

Código	Ref.	Color	U/Vta	U/Emb
15401539	SH-ELM335 BBL	Azul	1	60
15401541	SH-ELM335 BPK	Rosa	1	60
15401540	SH-ELM335 BRD	Violeta	1	60



Calculadora de sobremesa 12 dígitos

Código	Ref.	Medida	U/Vta	U/Emb
15401504	SH-EL124T WH	96x156x12mm	1	40
15401505	SH-EL125T WH	176x112x13mm	1	40



Calculadora de sobremesa EL-320W 12 dígitos

Código	Ref.	U/Vta	U/Emb
15401537	SH-EL320W	1	40



Calculadora de sobremesa EL-338GN 12 dígitos

Código	Ref.	U/Vta	U/Emb
15401510	SH-EL338GN	1	40



Calculadora de sobremesa EL-340W 12 dígitos

Código	Ref.	U/Vta	U/Emb
15401538	SH-EL340W	1	40



Calculadora impresora EL-2607PG 12 dígitos

Código	Ref.	U/Vta	U/Emb
15401521	SH-EL2607PG GYSE	1	6



Calculadora impresora EL-1750V 12 dígitos

Código	Ref.	U/Vta	U/Emb
15401520	SH-EL1750V	1	80



Calculadora científica EL-501X 10 dígitos

Código	Ref.	U/Vta	U/Emb
15401514	SH-EL501X BVL	1	80



Calculadora científica EL-531TH 10 dígitos (2 líneas)

Código	Ref.	Color	U/Vta	U/Emb
15401515	SH-EL531TH BGY	Gris	1	80
15401516	SH-EL531TH BGR	Verde	1	80

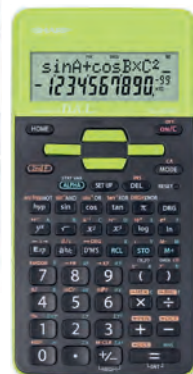
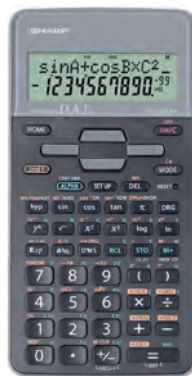

Calculadora científica EL-W531TH 16 dígitos (2 líneas)

Código	Ref.	U/Vta	U/Emb
15401542	SH-ELW531TH WH	1	80



Calculadora científica EL-W506T 16 dígitos (matriz de puntos)

Código	Ref.	U/Vta	U/Emb
15401519	SH-ELW506T	1	80





Calculadora financiera 10BII PLUS
12 dígitos

Código	Ref.	U/Vta	U/Emb
15401543	NW239AA (HP-10BII+)	1	2



Calculadora financiera 12C
10 dígitos

Código	Ref.	U/Vta	U/Emb
15401544	F2231AA (HP-12C PLAT)	1	2



Calculadora financiera 17BII PLUS
22 dígitos (2 líneas)

Código	Ref.	U/Vta	U/Emb
15401545	F2234A (HP-17BII+)	1	2



Calculadora gráfica Prime Graphing
Pantalla TFT multitáctil de 8,9 cm (3,5 pulgadas) en diagonal a todo color.
320 x 240 y 16 bits (10 líneas x 33 caracteres + menús + encabezados).
Conectividad USB.
Alimentación batería de ion litio recargable.
Memoria flash 256MB.
Apagado automático.
Dimensiones: 18,23 x 8,58 x 1,4 cm.
Peso 228g.
Uso de permisos: Cálculos AP, Estadísticas AP.
Prueba de razonamiento SAT.
Prueba de materias SAT en matemáticas nivel 1 y nivel 2.
PSAT/NMSQT.
Química/física AP.

Código	Ref.	U/Vta	U/Emb
15401595	2AP18AA	1	2



8
dígitos

Calculadora de bolsillo SL-100 VERA
Memoria independiente. Cálculo de porcentaje,
Peso: 35g. Medida: 10 x 87 x 58mm cerrada;
8 x 87 x 117,5mm abierta.

Código	Ref.	U/Vta	U/Emb
15401374	SL100VERA	1	10



8
dígitos

Calculadora de bolsillo SL-300 VERA
Funciones porcentual, memoria y
conversión de moneda.
Medidas 7,5 x 70 x 118,5 mm.

Código	Ref.	U/Vta	U/Emb
15401053	SL300VERA	1	10



8
dígitos

Calculadora de bolsillo HL-820 VERA
Con tapa. Teclas de formato grande.
Medidas: 7 x 123 x 102 mm.

Código	Ref.	U/Vta	U/Emb
15401003	HL820VERA	1	10



8
dígitos

Calculadora de bolsillo HS-8 VER
Cálculos con porcentaje. Con tapa. Teclas de
formato grande. Medidas: 10,3 x 61 x 102mm.

Código	Ref.	U/Vta	U/Emb
15401017	HS8VER	1	10

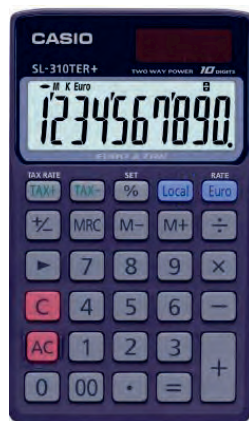

8
dígitos

Calculadora de bolsillo SL-310 TER.
Pantalla LC extra grande de 10 dígitos.
Conversión de moneda. Cálculo de porcentaje.
Alimentación combinada solar/batería.

Código	Ref.	U/Vta	U/Emb
15401396	SL310TER	1	10



12
dígitos

Calculadora de bolsillo SL-320 TER
12 Dígitos. Funciones: porcentaje, símbolo
+/-, Subdivisión, impuestos,
tecla doble cero. Medidas: 7,5 x 70 x 118,5 mm.

Código	Ref.	U/Vta	U/Emb
15401253	SL320TER	1	10



10
dígitos

Calculadora de Bolsillo 10 Dígitos SL-310 UC

Código	Ref.	Color	U/Vta	U/Emb
15401478	SL-310UC-BK	Negro	1	10
15401479	SL-310UC-BU	Azul	1	10
15401480	SL-310UC-GN	Verde	1	10
15401481	SL-310UC-PK	Rosa	1	10
15401482	SL-310UC-RD	Rojo	1	10
15401483	SL-310UC-RG	Naranja	1	10
15401484	SL-310UC-WE	Blanco	1	10



8 dígitos

Calculadora de sobremesa MS-8B
Función de cálculo de impuestos y conversión de moneda. Pantalla inclinada. Teclas de plástico. Dimensiones 28,8 x 103 x 147 mm

Código	Ref.	U/Vta	U/Emb
15401365	MS-8B	1	40



8 dígitos



Calculadora de sobremesa MS-80E
Convertidor a euros. Acabado metal. Pantalla inclinada LCD. Memoria independiente. Teclas de plástico. Cálculos porcentuales.

Código	Ref.	U/Vta	U/Emb
15401047	MS-80E	1	10



10 dígitos



Calculadora de sobremesa MS-100EM
Convertidor a euros. Acabado metal. Pantalla inclinada LCD. Memoria independiente. Tecla doble cero, cambio de signo. Cálculos porcentuales.

Código	Ref.	U/Vta	U/Emb
15401038	MS-100EM	1	10



10 dígitos



Calculadora sobremesa 10 dígitos MS-7UC

Código	Ref.	Color	U/Vta	U/Emb
15401487	MS-7UC-BU	Azul	1	100
15401488	MS-7UC-RD	Roja	1	100
15401489	MS-7UC-GN	Verde	1	100

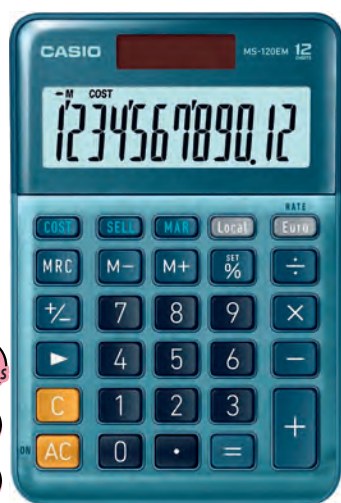

12 dígitos



Calculadora de sobremesa MS-120EM
Convertidor a euros. Acabado metal. Pantalla inclinada LCD. Memoria independiente. Tecla doble cero, cambio de signo. Cálculos porcentuales.

Código	Ref.	U/Vta	U/Emb
15401152	MS-120EM	1	10

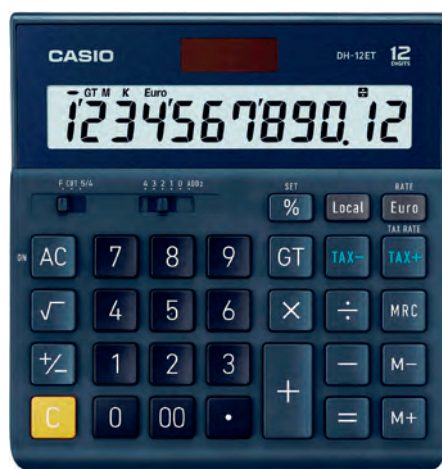

12 dígitos



Calculadora de sobremesa DH-12ET
Convertidor a euros, impuesto y memoria independiente. Acabado en plástico. Pantalla inclinada LCD. Tecla doble cero, cambio de signo. Cálculos porcentuales.

Código	Ref.	U/Vta	U/Emb
15401024	DH-12ET	1	10



12 dígitos



Calculadora de sobremesa DX-12B
Cálculo de porcentaje. Cálculo de raíz cuadrada. Pantalla LC. Memoria GT y 4 Key. Dimensiones 33,2 x 129 x 175,5 mm

Código	Ref.	U/Vta	U/Emb
15401184	DX-12B	1	40



12 dígitos

Calculadora de sobremesa GX-12B
Cálculo de porcentaje. Cálculo de raíz cuadrada.
Pantalla LC. Memoria doble.
Dimensiones 34,3 x 159 x 207,5 mm

Código	Ref.	U/Vta	U/Emb
15401223	GX-12B	1	40



12 dígitos

Calculadora de sobremesa MH-12
Cálculo de porcentaje. Cálculo de raíz cuadrada.
Pantalla inclinada LC. Memoria 4 Key.
Dimensiones 27,6 x 127 x 136,5 mm

Código	Ref.	U/Vta	U/Emb
15401241	MH-12	1	40



12 dígitos

Calculadora de sobremesa MX-12B
Cálculo de porcentaje. Pantalla LC.
Memoria 4 Key. Cubierta y teclas plástico
Dimensiones 29 x 106,5 x 147 mm

Código	Ref.	U/Vta	U/Emb
15401181	MX-12B	1	100



12 dígitos

Calculadora sobremesa 12 Dígitos MS-20UC

Código	Ref.	Color	U/Vta	U/Emb
15401437	MS-20UC-RG	Naranja	1	10
15401438	MS-20UC-BU	Azul	1	10
15401439	MS-20UC-RD	Roja	1	10
15401440	MS-20UC-GN	Verde	1	10
15401441	MS-20UC-PK	Rosa	1	10
15401485	MS-20UC-BK	Negro	1	10
15401486	MS-20UC-WE	Blanco	1	10

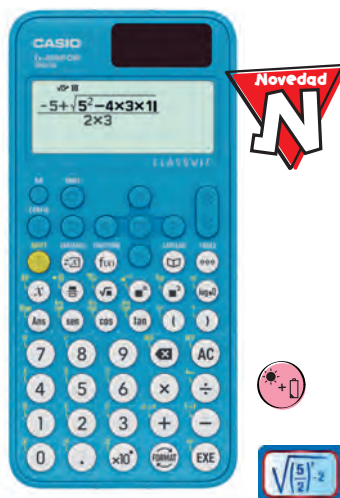

NATURAL TEXTBOOK DISPLAY

Calculadora Científica FX-85SP CW
10+2 dígitos
Texto matemático natural, pantalla LCD, +300 funciones, simplificación fracciones, cálculos fraccionarios, división entera, MCD, MCM, números primos, 6 líneas, 5 idiomas.

Código	Ref.	U/Vta	U/Emb
15401252	FX-85SP CW	1	10

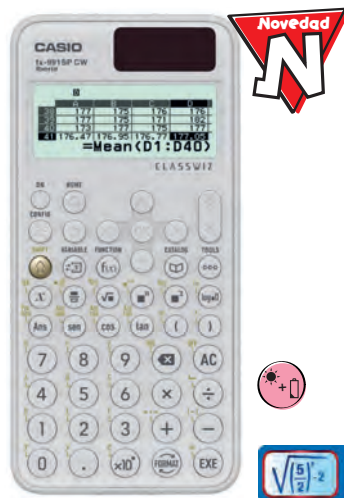

NATURAL TEXTBOOK DISPLAY

Calculadora Científica FX-991SP CW
10+2 dígitos (63 x 192 puntos)
Texto matemático natural, pantalla LCD, +560 funciones, derivadas/integrales, resolución numérica ecuaciones, MCD, MCM, matrices, probabilidad, 6 líneas, 5 idiomas

Código	Ref.	U/Vta	U/Emb
15401279	FX-991SP CW	1	10

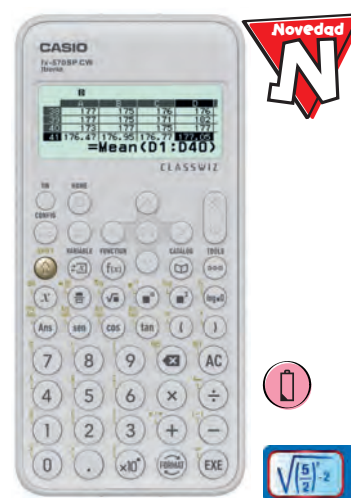

NATURAL TEXTBOOK DISPLAY

Calculadora Científica FX-570SP CW
10+2 dígitos (63 x 192 puntos)
Texto matemático natural, pantalla LCD, +560 funciones, derivadas/integrales, resolución numérica ecuaciones, MCD, MCM, matrices, probabilidad, 6 líneas, 5 idiomas

Código	Ref.	U/Vta	U/Emb
15401014	FX-570SP CW	1	10



Calculadora Científica FX-82SP CW
10+2 dígitos

Texto matemático natural, pantalla LCD, +300 funciones, simplificación fracciones, cálculos fraccionarios, división entera, MCD, MCM, números primos, 6 líneas, 5 idiomas

Código	Ref.	U/Vta	U/Emb
15404005	FX-82SP CW	1	10



Calculadora Científica FX 82MS 2
Calculadora científica con 240 funciones y pantalla de 2 líneas 10+2 dígitos

Código	Ref.	U/Vta	U/Emb
15401271	FX-82MS-2	1	10



Calculadora Científica FX 3650P
Calculadora programable con pantalla de 2 líneas y un nuevo diseño ergonómico. 10+2 dígitos

Código	Ref.	U/Vta	U/Emb
15401304	FX-3650PII	1	10



Calculadora Científica FX 5800P
Muy fácil de programar: le ayuda en la creación de numerosos programas y en el cálculo de números complejos.

Código	Ref.	U/Vta	U/Emb
15401259	FX5800P	1	10



Calculadora Financiera FC-100 V2
Calculadora financiera con distintas funciones como amortización de préstamos, cálculo de márgenes y de interés compuesto. Pantalla de 4 líneas. 10+2 dígitos

Código	Ref.	U/Vta	U/Emb
15401030	FC100V2	1	10



Calculadora Financiera FC 200 V2
Con funciones adicionales como cálculo de bonos y de depreciación, cálculo del punto de equilibrio. Pantalla de 4 líneas y doble alimentación. 10+2 dígitos

Código	Ref.	U/Vta	U/Emb
15401188	FC200V2	1	10



Calculadora de Impresión HR-8 RCE
Funciones de cálculo de impuestos. Adaptador CA opcional. Dimensiones: 42 x 102 x 209mm con el rollo contraído.

Código	Ref.	U/Vta	U/Emb
15401029	HR-8RCE	1	10



Calculadora de Impresión HR-150 RCE
Conversión Euro (3 divisas) Cálculo de ganancias (costo, venta, margen) Cálculo de impuesto. Impresión bicolor. Dimensión: 65 x 165 x 295 mm.

Código	Ref.	U/Vta	U/Emb
15401351	HR-150RCE	1	10



Altavoz Wild Dub Zero portátil Usb/SD/Bluetooth 120W

Código	Ref.	U/Vta	U/Emb
16901290	WILDDUBZERO	1	10



Auriculares con micro MS103PRO Jack

Código	Ref.	U/Vta	U/Emb
42501483	MS103PRO	1	10



Auriculares con micro Buzz Blab con base (doble conectividad bluetooth)

Código	Ref.	U/Vta	U/Emb
42501481	BUZZBLAB	1	10



Auriculares Artica Duo Touch control 4 earphones

Código	Ref.	Color	U/Vta	U/Emb
42501601	ARTICADUOWHITE	Blanco	1	10
42501602	ARTICADUOBLACK	Negro	1	10



Teclado y ratón Cocoa Usb con cable negro

Código	Ref.	U/Vta	U/Emb
42501389	COCOAKIT	1	10

Ratón Fog óptico inalámbrico

Código	Ref.	U/Vta	U/Emb
42501381	FOG	1	10



Ratón Haze óptico inalámbrico

Código	Ref.	Artículo	U/Vta	U/Emb
42501505	HAZE	Negro	1	10
42501503	HAZERED	Rojo	1	10
42501504	HAZEWHITE	Blanco	1	10



Ratón Kharma inalámbrico Multimode recargable

Código	Ref.	U/Vta	U/Emb
42501603	EVOKHARMA	1	10



Kit teclado + ratón inalámbrico Euphoria

Código	Ref.	U/Vta	U/Emb
42501478	EUPHORIAKIT	1	10



Kit teclado + ratón inalámbrico ultra slim

Código	Ref.	U/Vta	U/Emb
42501426	MATRIX KIT	1	10



Ratón Rust inalámbrico recargable

Código	Ref.	Color	U/Vta	U/Emb
42501604	EVORUSTICE	Negro y verde	1	10
42501605	EVORUSTGOLD	Negro y dorado	1	10
42501606	EVORUSTBLACK	Negro	1	10



Webcam Xpresscam Usb 2.0 1080 Full HD

Código	Ref.	U/Vta	U/Emb
42501394	XPRESSCAM1080	1	10



Hub Usb 4 puertos USB-C

Código	Ref.	U/Vta	U/Emb
45004517	WONDERDOCK4	1	10



Cargador portátil automático 8taps

Código	Ref.	Artículo	U/Vta	U/Emb
45003978	W-45W	45W	1	10
45003976	W-70W	70W	1	10



Regleta enchufe protector 8 salidas

Código	Ref.	U/Vta	U/Emb
42501489	POLE800	1	1



Maletín Monray Bureau 16" negro con ratón

Código	Ref.	U/Vta	U/Emb
42201484	BUREAUKIT	1	10



Auriculares Gembird MHS-123 negro
Micrófono y control volúmen

Código	Ref.	U/Vta	U/Emb
42501409	MHS-123	1	1



Auriculares Logitech H110 negro
Con micrófono

Código	Ref.	U/Vta	U/Emb
42511225	981-000271	1	1



Auriculares de botón Belkin con conector lightning y micrófono integrado

Código	Ref.	Artículo	U/Vta	U/Emb
42501553	G3H0001BTBLK	Negro	1	4
42501554	G3H0001BTWHT	Blanco	1	4



Auriculares de botón Belkin con conector USB-C y micrófono integrado

Código	Ref.	Artículo	U/Vta	U/Emb
42501555	G3H0002BTBLK	Negro	1	4
42501556	G3H0002BTWHT	Blanco	1	4



Auriculares Gembird MHS-001 negro
Micrófono y control volúmen

Código	Ref.	U/Vta	U/Emb
42501410	MHS-001	1	1



Auriculares Gembird Berlín blanco
Con bluetooth

Código	Ref.	U/Vta	U/Emb
42501411	BHP-BER-W	1	1



Auriculares Belkin bluetooth Soundform Mini kids

Código	Ref.	Artículo	U/Vta	U/Emb
42501551	AUD002BTBK	Negro	1	6
42501552	AUD002BTPK	Rosa	1	6



Teclado y ratón Logitech inalámbrico Desktop Mk220

Código	Ref.	U/Vta	U/Emb
42511161	920-003159	1	1



Combo teclado y ratón Logitech MK270 inalámbrico

Código	Ref.	U/Vta	U/Emb
42511237	920-004513	1	1



Ratón Logitech M185 óptico inalámbrico

Código	Ref.	Artículo	U/Vta	U/Emb
42504105	910-002235	Negro	1	1
42501097	910-002236	Azul	1	1



Teclado y ratón Logitech Desktop MK120

Código	Ref.	U/Vta	U/Emb
42511231	920-002550	1	1



Ratón Logitech M220 Silent óptico inalámbrico

Código	Ref.	Artículo	U/Vta	U/Emb
42501506	910-006129	Rosa	1	10
42501574	910-004878	Negro	1	10
42501575	910-004880	Rojo	1	10
42501576	910-006128	Blanco	1	10



Alfombrilla Sharkoon Skiller SFM11 redonda 120cm

Código	Ref.	U/Vta	U/Emb
24405234	4044951034338	1	1



Alfombrilla Sharkoon 1337 V2 negro

Código	Ref.	Artículo	U/Vta	U/Emb
42101260	4044951029945	L (35,5 x 25,5cm)	1	1
42101261	4044951029969	XXL (90 x 40cm)	1	1



Cargador inalámbrico Belkin

Código	Ref.	Artículo	U/Vta	U/Emb
42501571	WIA002VFBK	Negro	1	6
42501572	WIA002VFWH	Blanco	1	6



Webcam Logitech C925E 1080P HD negro

Código	Ref.	U/Vta	U/Emb
42501415	960-001076	1	1



Memoria usb Kioxia U301 3.2 blanco

Código	Ref.	Artículo	U/Vta	U/Emb
45003037	LU301W032G	32 Gb	1	20
45003038	LU301W064G	64 Gb	1	20
45003543	LU301W128G	128 Gb	1	20



Memoria usb Kioxia U202 2.0 blanco

Código	Ref.	Artículo	U/Vta	U/Emb
45013127	LU202W016G	16 Gb	1	20
45013139	LU202W032G	32 Gb	1	20
45001458	LU202W064G	64 Gb	1	20
45003542	LU202W128G	128 Gb	1	20



Adaptador Usb Wifi Tp-Link TL-WN725N

Código	Ref.	U/Vta	U/Emb
45016020	TL-WN725N	1	1

Extensor de cobertura Wifi AC750 1 puerto

Código	Ref.	U/Vta	U/Emb
45003810	RE200	1	1



Webcam Logitech C505E 720P HD negro

Código	Ref.	U/Vta	U/Emb
42501414	960-001364	1	1



Memoria usb Kioxia Aqua U202 2.0 azul

Código	Ref.	Artículo	U/Vta	U/Emb
45004389	LU202L016G	16 Gb	1	20
45004390	LU202L032G	32 Gb	1	20
45004391	LU202L064G	64 Gb	1	20

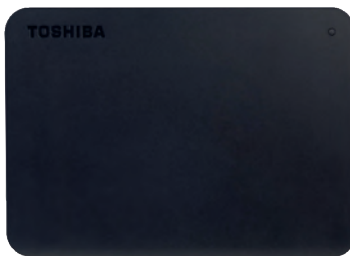

Disco duro externo 2,5" Toshiba 3.0 Canvio Basic

Código	Ref.	Artículo	U/Vta	U/Emb
45013325	HDTB410EK3AA	1 Tb	1	1
45013348	HDTB420EK3AA	2 Tb	1	1
45003691	HDTB440EK3CA	4 Tb	1	1



Micro SD Toshiba M203 UHS-I C10 R100

Código	Ref.	Artículo	U/Vta	U/Emb
45003188	LMEX1L032GG2	32 Gb	1	35
45003189	LMEX1L064GG2	64 Gb	1	20
45003190	LMEX1L128GG2	128 Gb	1	20
45003191	LMEX1L256GG2	256 Gb	1	20



Memoria usb Kioxia U366 3.2 metal

Código	Ref.	Artículo	U/Vta	U/Emb
45004362	LU366S016GG4	16 Gb	1	20
45004363	LU366S032GG4	32 Gb	1	20
45004364	LU366S064GG4	64 Gb	1	20
45004365	LU366S128GG4	128 Gb	1	20



Memoria usb Kingston DTX 3.2

Código	Ref.	Artículo	U/Vta	U/Emb
45013308	DTX/32GB	32 Gb	1	200
45013543	DTX/64GB	64 Gb	1	200
45001340	DTX/128GB	128 Gb	1	200
45003769	DTX/256GB	256 Gb	1	200



Funda para tablet Urban Standard Case para tablets de 9,7" hasta 10,2"

Código	Ref.	Color	U/Vta	U/Emb
42201502	MTTTABLETBLACK910	Negro	1	1
42201503	MTTTABLETRED910	Rojo	1	1
42201504	MTTTABLETPINK910	Rosa	1	1



Mochila Backpack Ginebra Usb 16" gris

Código	Ref.	U/Vta	U/Emb
42201506	MTGINEBRAGR	1	1



Funda para disco duro 2,5"

Código	Ref.	Color	U/Vta	U/Emb
42201498	MTCASE25BLK	Negro	1	1
42201499	MTCASE25RED	Rojo	1	1
42201500	MTCASE25BLU	Azul	1	1
42201501	MTCASE25PUR	Púrpura	1	1

Personalizamos equipos a tu medida.

Configuración personalizada para las necesidades de cada cliente.
Consulta a tu comercial para más información.

Te ofrecemos una amplia gama de:
Portátiles, Pdas, tablets, smartphones, y mucho más



Trabajamos con las marcas líderes en el mercado

TOSHIBA ↘ gembird TP-LINK logitech Lenovo LG Genius hp ASUS dynabook

ZONA GAMING



Ratón gaming Génesis Krypton 150
2400dpi óptico usd

Código	Ref.	U/Vta	U/Emb
42501417	NMG-1410	1	1



Ratón gaming Sharkoon Shark Force II
negro usb

Código	Ref.	U/Vta	U/Emb
42501512	4044951030439	1	1



Teclado gaming Sharkoon
Shark Skiller SGK30 usb

Código	Ref.	Artículo	U/Vta	U/Emb
42501513	4044951030873	Azul	1	1
42501514	4044951030866	Rojo	1	1



Teclado gaming Génesis Thor 300
brown switch rgb usb

Código	Ref.	U/Vta	U/Emb
42501416	NKG-1721	1	1



Auriculares gaming Génesis Neon 360
con vibración

Código	Ref.	U/Vta	U/Emb
42501418	NSG-1107	1	1



Auriculares Sharkoon Rush ER3 negro con micrófono

Código	Ref.	Artículo	U/Vta	U/Emb
42501508	4044951021697	Negro	1	1
42501509	4044951021802	Blanco	1	1



Auriculares Sharkoon Skiller SGH1
negro con micrófono

Código	Ref.	U/Vta	U/Emb
42501510	4044951018284	1	1





Auriculares diadema para niños
Kids Headphones

Código	Ref.	Color	U/Vta	U/Emb
42501255	BLUE KIDS	Azul	6	6
42501256	PINK KIDS	Rosa	6	6



Auriculares de botón Earbud Mic

Código	Ref.	Color	U/Vta	U/Emb
42501293	EARBUD MIC BLACK	Negro	1	48
42501294	EARBUD MIC WHITE	Blanco	1	48



Pilas Alcalinas

Código	Ref.	Blister	Tipo	U/Vta	U/Emb
23401095	O23A-B1MXL	1	12 Voltios	1	100
23401128	LR01-B1MXL	1	LR01	1	100
23401084	LR03-B4MXL	4	LR03	1	96
23401085	LR06-B4MXL	4	LR06	1	96
23401086	LR09-B1MXL	1	LR09/6LF22	1	240
23401087	LR14-B2MXL	2	LR14	1	72
23401088	LR20-B2 MXL	2	LR20	1	60

• Pack de 24

Código	Ref.	Tipo	U/Vta	U/Emb
23401174	LR03-PK24 MXL	LR03	1	48
23401173	LR06-PK24 MXL	LR06	1	24



Pilas Micro

Código	Ref.	Blister	Tipo	U/Vta	U/Emb
23401129	CR2016-B1MXL	1	CR2016 3V	1	100
23401130	CR2025-B1MXL	1	CR2025	1	100
23401124	CR2032-B1MXL	1	CR2032 3V	1	100
23401099	LR1130-B10MXL	2	LR1130 1,5V	1	100
23401143	392 (SR41W)	1	SR0041W 1,55V	1	100
23401100	364 (SR621SW)	1	SR0621SW 1,55V	1	100
23401101	377 (SR626SW)	1	SR0626SW 1,55V	1	100
23401144	395 (SR927SW)	1	SR0927SW 1,55V	1	100
23401102	390 (SR1130SW)	1	SR1130SW 1,55V	1	100



Pilas Micro 1,5V
Blister de 10

Código	Ref.	Artículo	U/Vta	U/Emb
23401148	LR0044-B10 MXL	LR0044W	1	20
23401175	LR0041-B10 MXL	LR0041W	1	200



Pilas recargables Alta Capacidad
Blister de 4

Código	Ref.	Tipo	U/Vta	U/Emb
23401179	270AAHC-CB4 GP	AA 2500 mAh	1	100
23401178	100AAAHC-CB4 GP	AAA 950 mAh	1	90

Panasonic



Pilas Alkaline Power

Código	Ref.	Tipo	U/Vta	U/Emb
23401165	LR6/4BP AP	AA LR06 Blister de 4	1	12
23401166	LR3/4BP AP	AAA LR03 Blister de 4	1	12
23401167	LR14/2BP AP	C LR14 Blister de 2	1	12
23401168	LR20/2BP AP	D LR20 Blister de 2	1	12
23401169	6LR61/1BP AP	9V LR61 Blister de 1	1	12

Transcend



Memoria Usb Jetflash 790 3.0

Código	Ref.	Artículo	U/Vta	U/Emb
45003126	TS16GJF790K	16 GB	1	25
45003127	TS32GJF790K	32 GB	1	25
45003128	TS64GJF790K	64 GB	1	25
45003600	TS128GJF790K	128 GB	1	25



Disco duro externo 2,5" Storejet 3.0
Antichoques

Código	Ref.	Artículo	U/Vta	U/Emb
45003597	TS1TSJ25M3S	1 TB	1	1
45003598	TS2TSJ25M3S	2 TB	1	1



Bolsa alimentos surtida

Código	Ref.	Color	U/Vta	U/Emb
25901026	30583	Repostería (15 piezas)	1	1
25901025	30582	Hortalizas (11 piezas)	1	1
25901024	30581	Fruta (15 piezas)	1	1
25901027	30584	Fiambre (16 piezas)	1	1
25901337	30585	Comida rápida (19 piezas)	1	1
25901338	30592	Alimentos envasados (5 piezas)	1	1



Figuras de animales
Bote con asa

Código	Ref.	Color	U/Vta	U/Emb
28801001	27460	Animales marinos (8 figuras)	1	1
28801002	27420	Animales granja (11 figuras)	1	1
28801005	25123	Animales de la selva (7 figuras)	1	1
28801003	25126	Animales del bosque (8 figuras)	1	1
28801007	25610	Dinosaurios (12 figuras)	1	1
28801008	27480	Insectos (12 figuras)	1	1



Juego Euro + Guía didáctica
28 billetes + 80 monedas

Código	Ref.	U/Vta	U/Emb
25001134	31908	1	1



Ábaco formas
1 ábaco, 100 formas y 24 fichas de actividades

Código	Ref.	U/Vta	U/Emb
25001133	95270	1	1



Juego Gigante cubo + vasitos apilables
10 vasos, 4 formas, 1 cubo y 1 tapa 95 cm

Código	Ref.	U/Vta	U/Emb
25001124	97211	1	1



Juego Minimobil 9 cm
4 piezas (+18 Meses)

Código	Ref.	U/Vta	U/Emb
25901465	32153	1	4



Juego Minimobil 12 cm
5 piezas

Código	Ref.	U/Vta	U/Emb
25901466	32154	1	6



ABCDEFGHI
JKLMNOPQR
STUVWXYZ

Estuche letras magnética mayúsculas Jumbo
(20 vocales/54 consonantes de 44mm)

Código	Ref.	U/Vta	U/Emb
24401452	97922	1	1

1234
5678
90=x
x+y

Estuche números magnéticos Jumbo
68 piezas de 45mm

Código	Ref.	U/Vta	U/Emb
24401453	97923	1	1



Bolas ensartables 20mm + 10 cordones de 1m
Bote de 100

Código	Ref.	U/Vta	U/Emb
25901030	31730	1	1



Pizarra dos caras 30 x 26 cm
para letras magnéticas
Set de 4

Código	Ref.	U/Vta	U/Emb
25001132	97930	1	1



Juego para pasta blanda 22 cm
Set de 5 accesorios

Código	Ref.	U/Vta	U/Emb
25001193	95251	1	12

Notas

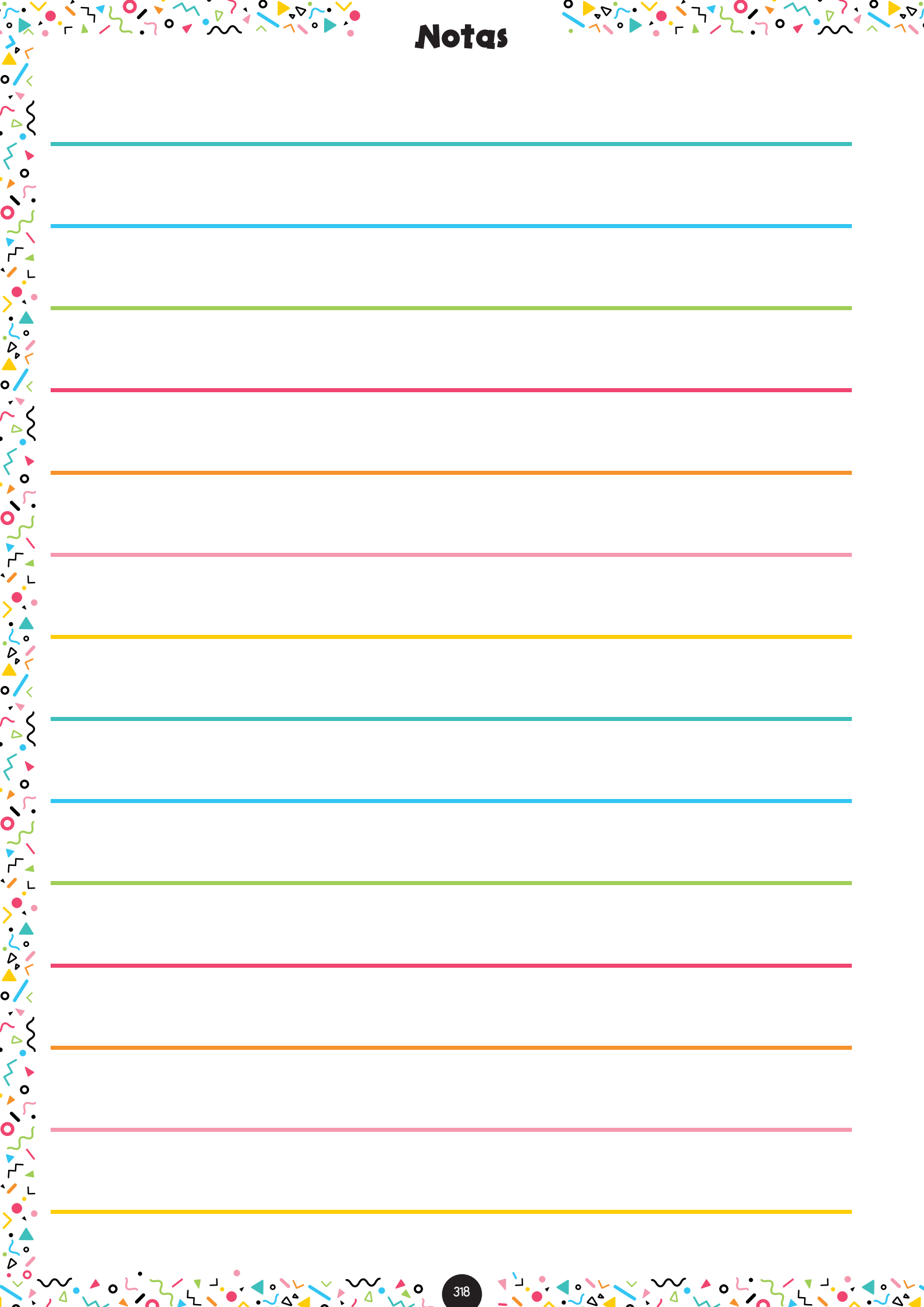

A series of horizontal lines for writing, alternating in color from top to bottom: teal, blue, green, pink, orange, pink, yellow, teal, blue, green, pink, orange, pink, yellow.

Notas

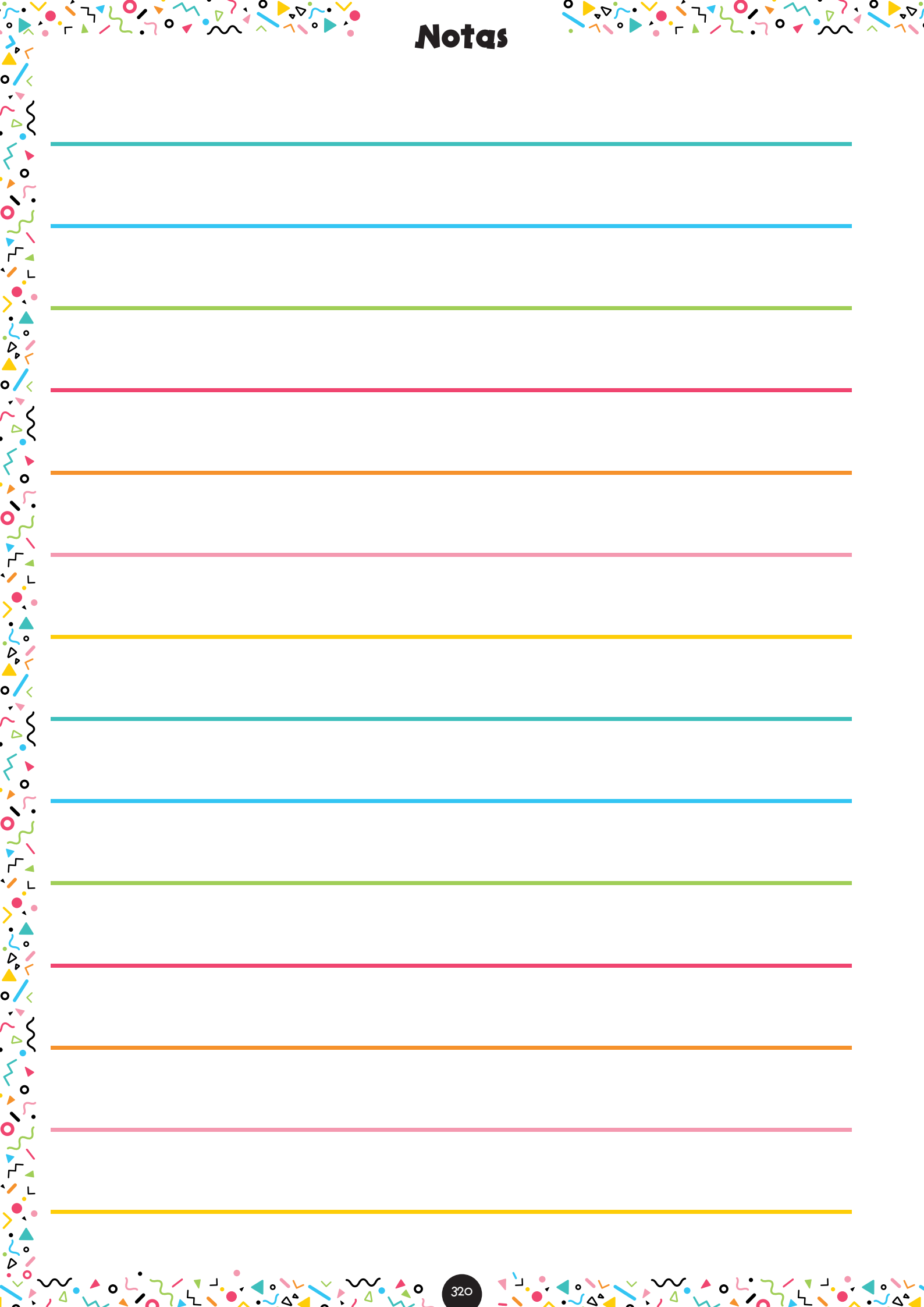

A series of horizontal lines for writing, alternating in color: teal, blue, green, pink, orange, pink, yellow, teal, blue, green, pink, orange, pink, yellow.

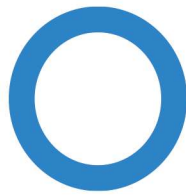

www.lucasrojas.com



ventas@lucasrojas.com
621 360 826

Valenzuela, 21
14540 La Rambla
Córdoba